

Valvole unidirezionali

Check valves

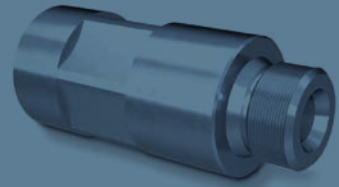

Sono valvole on/off che consentono flusso libero in un verso e lo bloccano nel verso contrario.

Vengono realizzate in corpi esagonali in acciaio adatti ad essere montati in linea con i tubi. Sono disponibili con 3 diversi valori di taratura: 0.5 bar, 2 bar, 5 bar.

These valves allow free flow in a direction and stop it in the opposite direction.

They are built in hexagonal bodies made of steel, suitable to be mounted in line with the hoses. They are available with 3 different setting values: 0.5 bar, 2 bar, 5 bar.

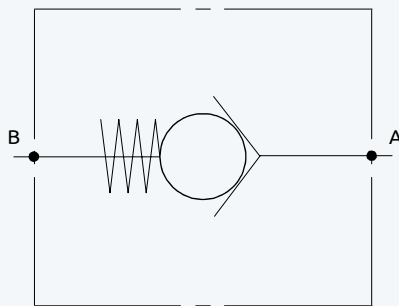



Valvola unidirezionale Check valve

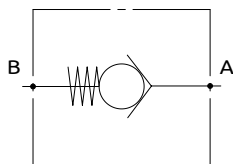

CURVE CARATTERISTICHE
PERFORMANCE CURVES

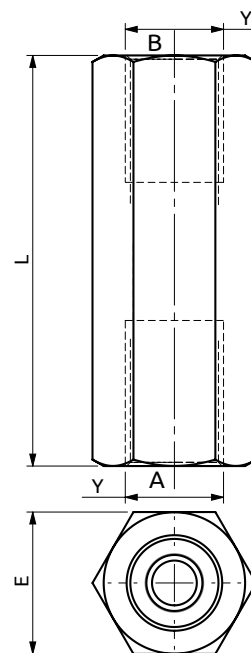
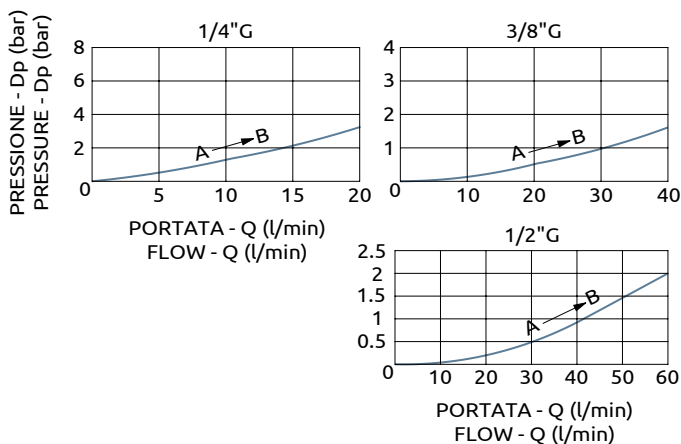

65	HEX27	1/2" G
60	HEX24	3/8" G
55	HEX19	1/4" G
L	E	Y

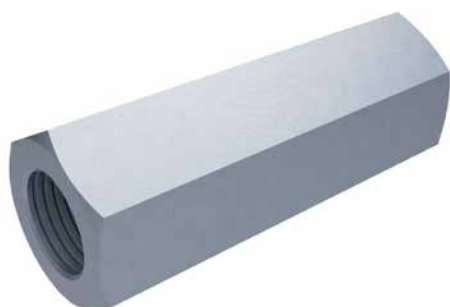

DESCRIZIONE

Sono valvole on/off che consentono flusso libero in un verso e lo bloccano nel verso contrario. Vengono realizzate in corpi esagonali in acciaio adatti ad essere montati in linea con i tubi. Sono disponibili con 3 diversi valori di taratura: 0.5 bar, 2 bar, 5 bar.

DESCRIPTION

These valves allow free flow in a direction and stop it in the opposite direction. They are built in hexagonal bodies made of steel, suitable to be mounted in line with the hoses. They are available with 3 different setting values: 0.5 bar, 2 bar, 5 bar.

Codice Ordinazione	Taratura Standard	Portata Massima	Pressione Max	Dimensione Porte	Peso
Ordering Code	Standard Setting	Max Flow	Max Pressure	Port Size	Weight
A120200.01.00	0.5 bar	15 l/min	700 bar	1/4" G	0.1 kg
A120200.02.00	2 bar	15 l/min	700 bar	1/4" G	0.1 kg
A120200.03.00	5 bar	15 l/min	700 bar	1/4" G	0.1 kg
A120300.01.00	0.5 bar	35 l/min	700 bar	3/8" G	0.17 kg
A120300.02.00	2 bar	35 l/min	700 bar	3/8" G	0.17 kg
A120300.03.00	5 bar	35 l/min	700 bar	3/8" G	0.17 kg
A120400.01.00	0.5 bar	50 l/min	700 bar	1/2" G	0.25 kg
A120400.02.00	2 bar	50 l/min	700 bar	1/2" G	0.25 kg
A120400.03.00	5 bar	50 l/min	700 bar	1/2" G	0.25 kg



Valvola unidirezionale Check valve

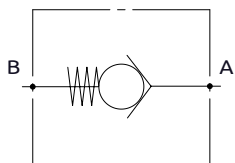

CURVE CARATTERISTICHE
PERFORMANCE CURVES

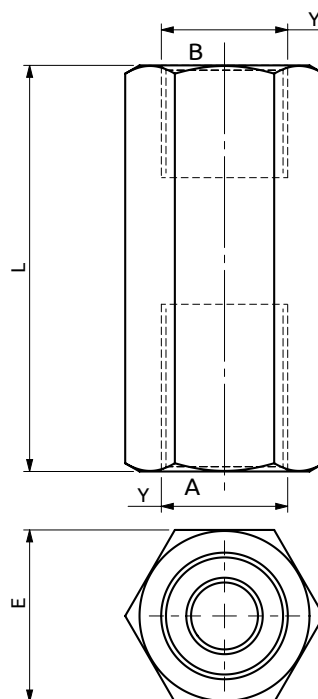
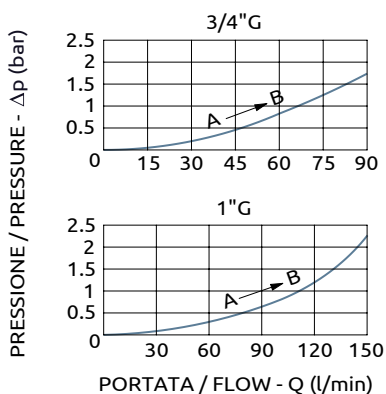

90	HEX42	1"G
85	HEX36	3/4"G
L	E	Y

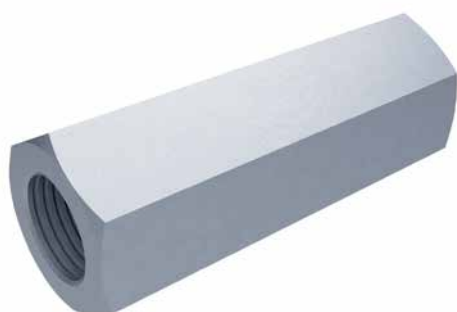

DESCRIZIONE

Sono valvole on/off che consentono flusso libero in un verso e lo bloccano nel verso contrario. Vengono realizzate in corpi esagonali in acciaio adatti ad essere montati in linea con i tubi. Sono disponibili con 3 diversi valori di taratura: 0.5 bar, 2 bar, 5 bar.

DESCRIPTION

These valves allow free flow in a direction and stop it in the opposite direction. They are built in hexagonal bodies made of steel, suitable to be mounted in line with the hoses. They are available with 3 different setting values: 0.5 bar, 2 bar, 5 bar.

Codice Ordine	Taratura Standard	Portata Massima	Pressione Max	Dimensione Porte	Peso
Ordering Code	Standard Setting	Max Flow	Max Pressure	Port Size	Weight
A120600.01.00	0.5 bar	90 l/min	700 bar	3/4"G	0.42 kg
A120600.02.00	2 bar	90 l/min	700 bar	3/4"G	0.42 kg
A120600.03.00	5 bar	90 l/min	700 bar	3/4"G	0.42 kg
A120800.01.00	0.5 bar	150 l/min	700 bar	1"G	0.48 kg
A120800.02.00	2 bar	150 l/min	700 bar	1"G	0.48 kg
A120800.03.00	5 bar	150 l/min	700 bar	1"G	0.48 kg



Valvola unidirezionale Check valve

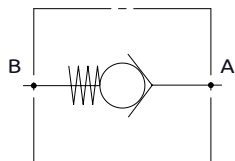

CURVE CARATTERISTICHE
PERFORMANCE CURVES

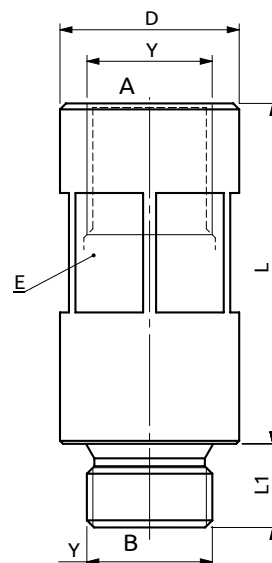
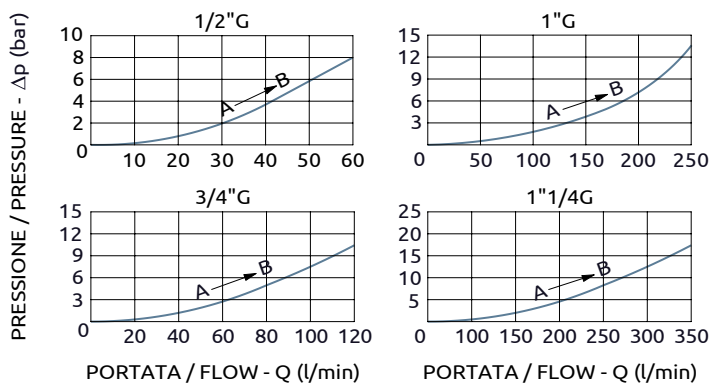

Ø55	102	20	HEX50	1"1/4G
Ø46	82	18	HEX41	1"G
Ø36	69	16	HEX32	3/4"G
Ø30	57	14	HEX27	1/2"G
D	L	L1	E	Y



DESCRIZIONE

Sono valvole on/off che consentono flusso libero in un verso e lo bloccano nel verso contrario. Vengono realizzate in corpi esagonali in acciaio adatti ad essere montati in linea con i tubi. Sono disponibili con 3 diversi valori di taratura: 0.5 bar, 2 bar, 5 bar.

DESCRIPTION

These valves allow free flow in a direction and stop it in the opposite direction. They are built in hexagonal bodies made of steel, suitable to be mounted in line with the hoses. They are available with 3 different setting values: 0.5 bar, 2 bar, 5 bar.

Codice Ordinazione	Pressione di Inizio Apertura	Portata Massima	Pressione Max	Dimensione Porte	Peso
Ordering Code	Cracking Pressure	Max Flow	Max Pressure	Port Size	Weight
A120410.01.00	10 bar	60 l/min	350 bar	1/2"G	0.25 kg
A120610.01.00	10 bar	130 l/min	350 bar	3/4"G	0.4 kg
A120810.01.00	10 bar	250 l/min	350 bar	1"G	0.8 kg
A121010.01.00	10 bar	350 l/min	350 bar	1"1/4G	1.4 kg



Valvola unidirezionale a cartuccia Cartridge check valve

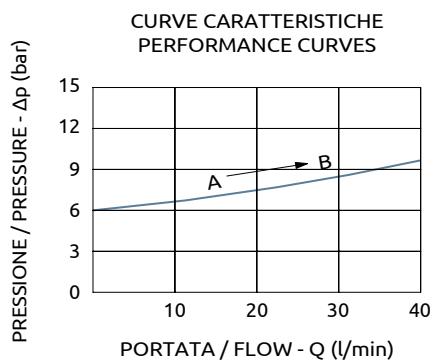
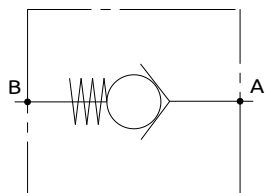

CODICE SEDE	CAVITY CODE
-------------	-------------

HBS.39.M.02A (Pag. 99.04.00)

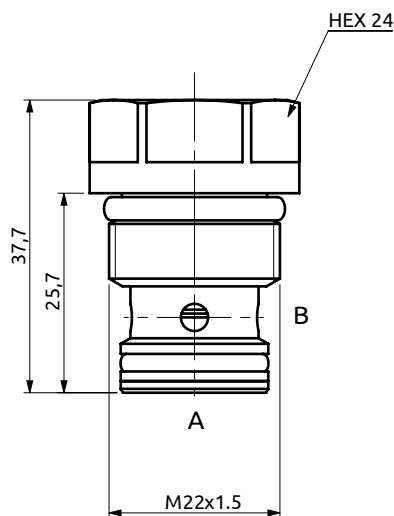

DESCRIZIONE

Sono valvole on/off che consentono flusso libero in un verso e lo bloccano nel verso contrario. Vengono realizzate in corpi esagonali in acciaio adatti ad essere montati in linea con i tubi. Sono disponibili con 3 diversi valori di taratura: 0.5 bar, 2 bar, 5 bar.

DESCRIPTION

These valves allow free flow in a direction and stop it in the opposite direction. They are built in hexagonal bodies made of steel, suitable to be mounted in line with the hoses. They are available with 3 different setting values: 0.5 bar, 2 bar, 5 bar.

COPPIA DI SERRAGGIO

INSTALLATION TORQUE

45 Nm

Codice Ordinazione	Pressione d'inizio Apertura	Portata Massima	Pressione Max	Peso
Ordering Code	Cracking Pressure	Max Flow	Max Pressure	Weight
C123900.01.00	4.5 bar	40 l/min	350 bar	0.15 kg
C123900.02.00	9.0 bar	40 l/min	350 bar	0.15 kg
C123900.03.00	30 bar	40 l/min	350 bar	0.15 kg



Valvola unidirezionale a cartuccia Cartridge check valve

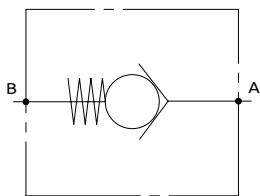

CURVE CARATTERISTICHE
PERFORMANCE CURVES

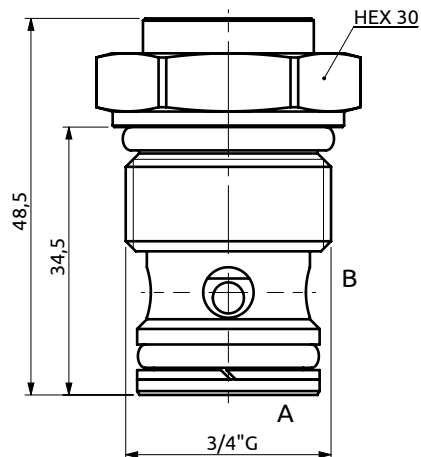
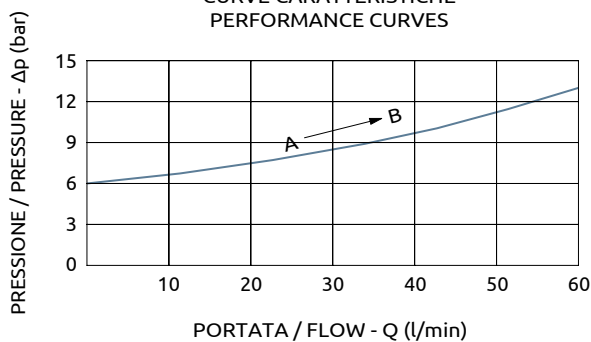

CODICE SEDE	CAVITY CODE
HBS.06.G.02A (Pag. 99.07.01)	



DESCRIZIONE	DESCRIPTION
Sono valvole on/off che consentono flusso libero in un verso e lo bloccano nel verso contrario. Vengono realizzate in corpi esagonali in acciaio adatti ad essere montati in linea con i tubi. Sono disponibili con 3 diversi valori di taratura: 0.5 bar, 2 bar, 5 bar.	These valves allow free flow in a direction and stop it in the opposite direction. They are built in hexagonal bodies made of steel, suitable to be mounted in line with the hoses. They are available with 3 different setting values: 0.5 bar, 2 bar, 5 bar.

COPPIA DI SERRAGGIO	INSTALLATION TORQUE
100 Nm	

Codice Ordinazione	Pressione d'inizio Apertura	Portata Massima	Pressione Max	Peso
Ordering Code	Cracking Pressure	Max Flow	Max Pressure	Weight
C120600.01.00	6 bar	60 l/min	350 bar	0.15 kg



Valvola unidirezionale a cartuccia Cartridge check valve

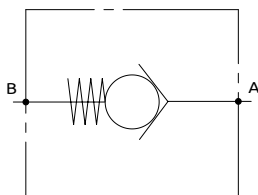

CURVE CARATTERISTICHE
PERFORMANCE CURVES

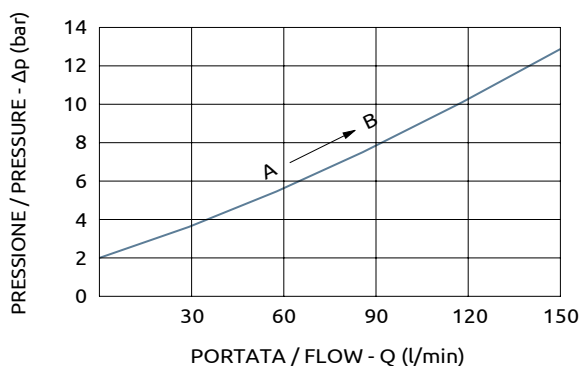

CODICE SEDE	CAVITY CODE
HBS.97.U.02A (Pag. 99.01.01)	

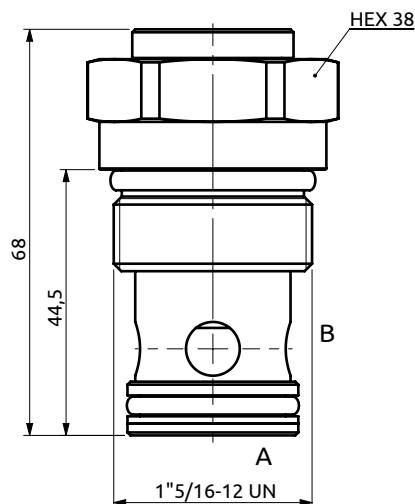

DESCRIZIONE	DESCRIPTION
Sono valvole on/off che consentono flusso libero in un verso e lo bloccano nel verso contrario. Vengono realizzate in corpi esagonali in acciaio adatti ad essere montati in linea con i tubi. Sono disponibili con 3 diversi valori di taratura: 0.5 bar, 2 bar, 5 bar.	These valves allow free flow in a direction and stop it in the opposite direction. They are built in hexagonal bodies made of steel, suitable to be mounted in line with the hoses. They are available with 3 different setting values: 0.5 bar, 2 bar, 5 bar.

COPPIA DI SERRAGGIO	INSTALLATION TORQUE
90 Nm	

Codice Ordinazione	Pressione d'inizio Apertura	Portata Massima	Pressione Max	Peso
Ordering Code	Cracking Pressure	Max Flow	Max Pressure	Weight
C129700.01.00	4 bar	150 l/min	400 bar	0.3 kg

