

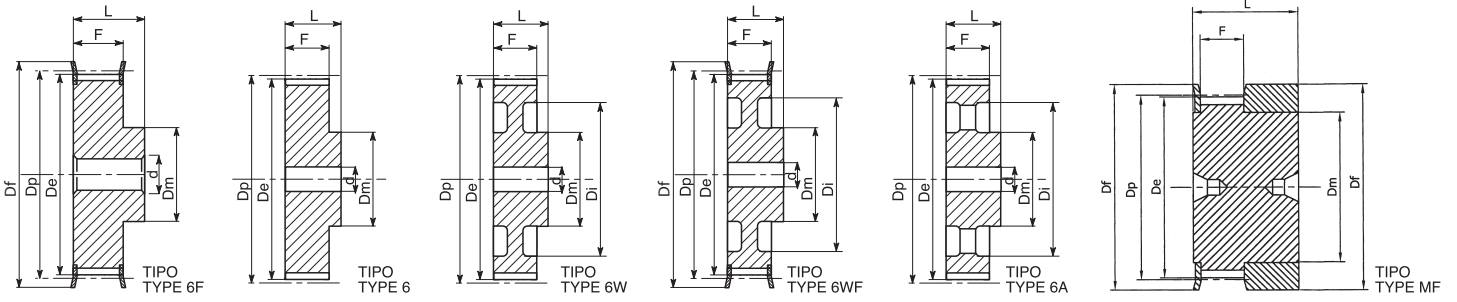

PULEGGE PER CINGHIE DENTATE

Timing belt pulleys
Zoll-Zahnriemenscheiben
Poulies pour courroies dentées
Poleas para correas dentadas



MXL 025 - 0,080" (2,032 mm)

Caratteristiche Features Merkmale Características	Codice Code symbol Bezeichnung Code symbole Numero de fabrica	Cod.	Tipo Type Typ Tipo	Codice flangia Flange code Bordscheiben Typ Code flasque Código brida	N. denti N. of teeth Zähnezahl N. bre de dents Cantidad de dientes	Dp	De	Df	Dm	Di	F	L	Foro stock Stock bore Vor bohrung Alesage en stock Agujero de stock	Peso Weight Gewicht Poids Peso Kg	
Alluminio / Aluminium / Aluminum / Aluminium / Aluminium / Aluminium con flangia / with flanges mit Bordscheiben / avec flasques con tapetas	16 MXL 025	MXL 2516	MF	FL502	16	10,35	9,84	15,0	8	-	8,5	16	-	0,01	
	18 MXL 025	MXL 2518	MF	FL503	18	11,64	11,12	16,0	9,5	-	8,5	16	-	0,01	
	20 MXL 025	MXL 2520	MF	FL503	20	12,94	12,43	16,0	9,5	-	8,5	16	-	0,01	
	22 MXL 025	MXL 2522	6F	FL504	22	14,23	13,72	17,5	10	-	11,0	16	3	0,01	
	24 MXL 025	MXL 2524	6F	FL505	24	15,52	15,01	20,0	10	-	11,0	16	3	0,01	
	28 MXL 025	MXL 2528	6F	FL506	28	18,11	17,60	25,0	11	-	11,0	16	3	0,02	
	30 MXL 025	MXL 2530	6F	FL506	30	19,40	18,90	25,0	12	-	11,0	16	4	0,03	
	32 MXL 025	MXL 2532	6F	FL507	32	20,70	20,19	26,0	14	-	11,0	16	4	0,03	
	36 MXL 025	MXL 2536	6F	FL508	36	23,29	22,78	28,0	16	-	11,0	16	4	0,03	
	40 MXL 025	MXL 2540	6F	FL509	40	25,87	25,37	32,0	18	-	11,0	16	4	0,04	
	42 MXL 025	MXL 2542	6F	FL509	42	27,17	26,67	32,0	18	-	11,0	16	5	0,04	
	44 MXL 025	MXL 2544	6F	FL510	44	28,46	27,95	36,0	18	-	11,0	16	5	0,45	
	Alluminio / Aluminium / Aluminum / Aluminium / Aluminium / Aluminium senza flangia / without flanges / ohne Bordscheiben sans flasques / sin tapetas	48 MXL 025	MXL 2548	6	-	48	31,05	30,54	-	20	-	11,0	16	5	0,05
		60 MXL 025	MXL 2560	6	-	60	38,81	38,30	-	24	-	11,0	16	5	0,08
72 MXL 025		MXL 2572	6	-	72	46,57	46,06	-	25	-	11,0	16	6	0,11	

XL 037 - 1/5" (5,08 mm)

Caratteristiche Features Merkmale Características	Codice Code symbol Bezeichnung Code symbole Numero de fabrica	Cod.	Tipo Type Typ Tipo	Codice flangia Flange code Bordscheiben Typ Code flasque Código brida	N. denti N. of teeth Zähnezahl N. bre de dents Cantidad de dientes	Dp	De	Df	Dm	Di	F	L	Foro stock Stock bore Vor bohrung Alesage en stock Agujero de stock	Peso Weight Gewicht Poids Peso Kg	
Alluminio / Aluminium / Aluminium / Aluminium / Aluminium / Aluminium con flangia / with flanges mit Bordscheiben / avec flasques / con tapetas	10 XL 037	XA37010 XC37010	6F	FL001	10	16,17	15,66	23,0	9,5	-	14,3	20	-	0,02	
	11 XL 037	XA37011 XC37011	6F	FL001	11	17,79	17,28	23,0	9,5	-	14,3	20	-	0,02	
	12 XL 037	XA37012 XC37012	6F	FL002	12	19,40	18,90	25,0	10	-	14,3	20	-	0,03	
	13 XL 037	XA37013 XC37013	6F	FL002	13	21,02	20,51	25,0	10	-	14,3	20	-	0,04	
	14 XL 037	XA37014 XC37014	6F	FL004	14	22,64	22,13	28,0	15	-	14,3	20	-	0,05	
	15 XL 037	XA37015 XC37015	6F	FL004	15	24,26	23,75	28,0	15	-	14,3	20	-	0,05	
	16 XL 037	XA37016 XC37016	6F	FL005	16	25,87	25,36	32,0	16	-	14,3	20	-	0,06	
	17 XL 037	XA37017 XC37017	6F	FL006	17	27,49	26,98	32,0	20	-	14,3	20	-	0,07	
	18 XL 037	XA37018 XC37018	6F	FL007	18	29,11	28,60	35,0	20	-	14,3	20	-	0,08	
	19 XL 037	XA37019 XC37019	6F	FL007	19	30,72	30,22	35,0	20	-	14,3	22	-	0,09	
	20 XL 037	XA37020 XC37020	6F	FL009	20	32,34	31,83	38,0	24	-	14,3	22	-	0,11	
	21 XL 037	XA37021 XC37021	6F	FL009	21	33,96	33,45	38,0	24	-	14,3	22	-	0,12	
	22 XL 037	XA37022 XC37022	6F	FL010	22	35,57	35,07	41,0	25	-	14,3	22	-	0,13	
	24 XL 037	XA37024 XC37024	6F	FL012	24	38,81	38,30	44,0	30	-	14,3	22	-	0,15	
	26 XL 037	XA37026 XC37026	6F	FL011	26	42,04	41,53	48,0	30	-	14,3	22	8	0,19	
	27 XL 037	XA37027 XC37027	6F	FL011	27	43,66	43,15	48,0	34	-	14,3	22	8	0,20	
	28 XL 037	XA37028 XC37028	6F	FL016	28	45,28	44,77	51,0	34	-	14,3	22	8	0,22	
	29 XL 037	XA37029 XC37029	6F	FL016	29	46,89	46,39	51,0	34	-	14,3	22	8	0,22	
	30 XL 037	XA37030 XC37030	6F	FL018	30	48,51	48,00	54,0	38	-	14,3	22	8	0,11	
	32 XL 037	XA37032 XC37032	6F	FL020	32	51,74	51,24	57,0	38	-	14,3	25	8	0,12	
	Altern. / Altern. Alterm. / Alterm. Acier / Acero senza flangia / without flanges sans flasques / sin tapetas	34 XL 037	XA37034 XC37034	6	-	34	54,98	54,47	-	45	-	14,3	25	8	0,12
		35 XL 037	XA37035 XC37035	6	-	35	56,60	56,09	-	45	-	14,3	25	8	0,13
		36 XL 037	XA37036 XC37036	6	-	36	58,21	57,70	-	45	-	14,3	25	8	0,14
		38 XL 037	XA37038 XC37038	6	-	38	61,45	60,94	-	45	-	14,3	25	8	0,16
39 XL 037		XA37039 XC37039	6	-	39	63,06	62,56	-	45	-	14,3	25	8	0,17	
40 XL 037		XA37040 XC37040	6	-	40	64,68	64,17	-	45	-	14,3	25	8	0,17	
41 XL 037		XA37041 XC37041	6	-	41	66,30	65,79	-	45	-	14,3	25	8	0,18	
42 XL 037		XA37042 XC37042	6	-	42	67,91	67,41	-	45	-	14,3	25	8	0,18	
43 XL 037		XA37043 XC37043	6	-	43	69,53	69,02	-	45	-	14,3	25	8	0,19	
44 XL 037		XA37044 XC37044	6	-	44	71,15	70,64	-	45	-	14,3	25	8	0,19	
45 XL 037		XA37045 XC37045	6W	-	45	72,77	72,26	-	45	61	14,3	25	10	0,19	
46 XL 037		XA37046 XC37046	6W	-	46	74,38	73,87	-	45	61	14,3	25	10	0,19	
47 XL 037		XA37047 XC37047	6W	-	47	76,00	75,49	-	45	61	14,3	25	10	0,19	
48 XL 037		XA37048 XC37048	6W	-	48	77,62	77,11	-	45	61	14,3	25	10	0,19	
49 XL 037		XA37049 XC37049	6W	-	49	79,23	78,73	-	45	61	14,3	25	10	0,22	
52 XL 037		XA37052 XC37052	6W	-	52	84,08	83,58	-	45	67	14,3	25	10	0,22	
56 XL 037		XA37056 XC37056	6W	-	56	90,55	90,04	-	45	80	14,3	25	10	0,25	
57 XL 037		XA37057 XC37057	6W	-	57	92,17	91,66	-	45	80	14,3	25	10	0,25	
58 XL 037		XA37058 XC37058	6W	-	58	93,79	93,28	-	45	80	14,3	25	10	0,25	
59 XL 037		XA37059 XC37059	6W	-	59	95,40	94,90	-	45	80	14,3	25	10	0,25	
60 XL 037	XA37060 XC37060	6W	-	60	97,02	96,51	-	45	80	14,3	25	10	0,25		
68 XL 037	XA37068 XC37068	6W	-	68	109,96	109,45	-	45	100	14,3	25	10	0,30		
69 XL 037	XA37069 XC37069	6W	-	69	111,57	111,07	-	45	100	14,3	25	10	0,30		
70 XL 037	XA37070 XC37070	6W	-	70	113,19	112,68	-	45	100	14,3	25	10	0,30		
71 XL 037	XA37071 XC37071	6W	-	71	114,81	114,30	-	45	100	14,3	25	10	0,30		
72 XL 037	XA37072 XC37072	6W	-	72	116,42	115,92	-	45	100	14,3	25	10	0,30		

Pulegge per cinghie dentate / Timing belt pulleys / Zoll-Zahnriemenscheiben Poulies pour courroies dentées / Poleas para correas dentadas

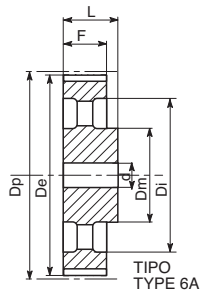
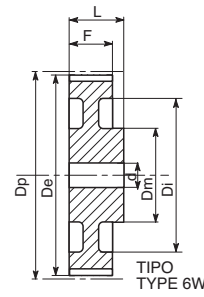
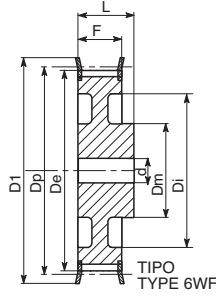
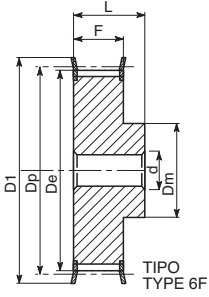

L 100 - 3/8" (9,525 mm)

Caratteristiche Features Merkmale Características Características	Codice Code symbol Bezeichnung Code symbole Numero de fabrica	Cod.	Tipo Type Typ Type Tipo	Codice flangia Flange code Bordscheiben Typ Code flasque Código brida	N. denti N. of teeth Zähnezahl N. bre de dents Cantidad de dientes	Dp	De	Df	Dm	Di	F	L	Foro stock Stock bore Vorbohrung Alesage en stock Agujero de stock	Peso Weight / Gewicht Poids / Peso Kg		
Acciaio / Steel / Stahl Acier / Acero	con flangia / with flanges mit Bordscheiben / avec flasques / con tapetas	10L100	6F	FL050	10	30,32	29,56	37,0	20	-	31,8	45	8	0,15		
		11L100	6F	FL050	11	33,35	32,59	37,0	22	-	31,8	45	8	0,20		
		12L100	6F	FL052	12	36,38	35,62	43,0	24	-	31,8	45	8	0,26		
		13L100	6F	FL083	13	39,41	38,65	44,0	28	-	31,8	45	8	0,30		
		14L100	6F	FL054	14	42,45	41,68	48,0	28	-	31,8	45	11	0,34		
		15L100	6F	FL055	15	45,48	44,72	51,0	34	-	31,8	45	11	0,45		
		16L100	6F	FL056	16	48,51	47,75	54,0	36	-	31,8	45	11	0,52		
		17L100	6F	FL057	17	51,54	50,78	57,0	36	-	31,8	45	11	0,53		
		18L100	6F	FL058	18	54,57	53,81	60,0	40	-	31,8	45	11	0,62		
		19L100	6F	FL059	19	57,61	56,84	64,0	40	-	31,8	45	11	0,66		
		20L100	6F	FL060	20	60,64	59,88	66,5	40	-	31,8	45	11	0,72		
		21L100	6F	FL061	21	63,67	62,91	70,0	45	-	31,8	45	11	0,77		
		22L100	6F	FL062	22	66,70	65,94	75,0	45	-	31,8	45	11	0,88		
		23L100	6F	FL063	23	69,73	68,97	79,0	55	-	31,8	45	11	1,12		
		24L100	6F	FL063	24	72,77	72,00	79,0	55	-	31,8	45	11	1,13		
		25L100	6F	FL064	25	75,80	75,04	82,5	58	-	31,8	45	11	1,18		
		26L100	6F	FL065	26	78,83	78,07	86,0	58	-	31,8	45	11	1,24		
		27L100	6F	FL065	27	81,86	81,10	86,0	58	-	31,8	45	11	1,35		
		28L100	6F	FL066	28	84,89	84,13	91,0	58	-	31,8	45	11	1,42		
		29L100	6F	FL067	29	87,93	87,16	94,0	58	-	31,8	45	11	1,50		
		30L100	6F	FL068	30	90,96	90,20	97,0	70	-	31,8	45	11	1,61		
		32L100	6F	FL070	32	97,02	96,26	102,0	70	-	31,8	45	11	1,84		
		33L100	6F	FL071	33	100,05	99,29	106,0	70	-	31,8	45	11	1,95		
		34L100	6F	FL072	34	103,08	102,32	112,0	70	-	31,8	45	11	2,10		
		35L100	6F	FL072	35	106,12	105,35	112,0	70	-	31,8	45	11	2,23		
		36L100	6F	FL074	36	109,15	108,39	115,0	70	-	31,8	45	11	2,32		
		40L100	6WF	FL078	40	121,28	120,51	128,0	70	100	31,8	45	11	2,80		
		41L100	6WF	FL080	41	124,31	123,55	135,0	70	103	31,8	45	11	2,95		
		42L100	6WF	FL080	42	127,34	126,58	135,0	70	106	31,8	45	11	3,10		
		44L100	6WF	FL081	44	133,40	132,62	142,0	70	112	31,8	45	11	3,36		
		45L100	6WF	FL081	45	136,44	135,67	142,0	70	115	31,8	45	11	3,45		
		47L100	6WF	FL085	47	142,50	141,74	150,0	70	121	31,8	45	11	3,65		
		48L100	6WF	FL085	48	145,53	144,77	150,0	70	124	31,8	45	11	3,86		
		Ghisa / Cast iron / Grauguss Fonte / Hierro fundido	senza flangia / without flanges ohne Bordscheiben / sans flasques sin tapetas	49L100	6W	-	49	148,56	147,80	-	70	127	31,8	45	14	2,40
				50L100	6W	-	50	151,60	150,83	-	70	130	31,8	45	14	2,50
				52L100	6W	-	52	157,66	156,90	-	70	136	31,8	45	14	2,70
				56L100	6W	-	56	169,79	169,02	-	70	149	31,8	45	14	2,91
				57L100	6W	-	57	172,82	172,06	-	70	152	31,8	45	14	3,10
				60L100	6W	-	60	181,91	181,15	-	75	160	31,8	50	14	3,55
				65L100	6A	-	65	197,07	196,31	-	75	176	31,8	50	14	4,00
				66L100	6A	-	66	200,11	199,34	-	75	179	31,8	50	14	4,15
				72L100	6A	-	72	218,30	217,53	-	75	197	31,8	50	14	5,00
				84L100	6A	-	84	254,68	253,92	-	75	233	31,8	50	14	6,30
				90L100	6A	-	90	272,87	272,11	-	75	252	31,8	50	14	7,50
				96L100	6A	-	96	291,06	290,30	-	75	269	31,8	50	14	8,20
				120L100	6A	-	120	363,83	363,07	-	75	342	31,8	50	14	11,50

H 075 - 1/2" (12,75 mm)

Caratteristiche Features Merkmale Características Características	Codice Code symbol Bezeichnung Code symbole Numero de fabrica	Cod.	Tipo Type Typ Type Tipo	Codice flangia Flange code Bordscheiben Typ Code flasque Código brida	N. denti N. of teeth Zähnezahl N. bre de dents Cantidad de dientes	Dp	De	Df	Dm	Di	F	L	Foro stock Stock bore Vorbohrung Alesage en stock Agujero de stock	Peso Weight / Gewicht Poids / Peso Kg		
Acciaio / Steel / Stahl Acier / Acero	con flangia / with flanges mit Bordscheiben / avec flasques / con tapetas	14H075	6F	FL059	14	56,60	55,22	64,0	40	-	26,4	40	8	0,59		
		15H075	6F	FL060	15	60,64	59,27	66,5	45	-	26,4	40	8	0,65		
		16H075	6F	FL061	16	64,68	63,31	70,0	45	-	26,4	40	8	0,70		
		17H075	6F	FL062	17	68,72	67,35	75,0	45	-	26,4	40	8	0,73		
		18H075	6F	FL063	18	72,77	71,39	79,0	55	-	26,4	40	11	0,91		
		19H075	6F	FL064	19	76,81	75,44	82,5	60	-	26,4	40	11	1,08		
		20H075	6F	FL076	20	80,85	79,48	87,0	62	-	26,4	40	11	1,18		
		21H075	6F	FL066	21	84,89	83,52	91,0	65	-	26,4	40	11	1,30		
		22H075	6F	FL067	22	88,94	87,56	94,0	68	-	26,4	40	11	1,42		
		23H075	6F	FL068	23	92,98	91,61	97,0	72	-	26,4	40	11	1,67		
		24H075	6F	FL070	24	97,02	95,65	102,0	72	-	26,4	40	11	1,71		
		25H075	6F	FL071	25	101,06	99,69	106,0	72	-	26,4	40	11	1,87		
		26H075	6F	FL072	26	105,11	103,73	112,0	80	-	26,4	40	11	2,00		
		27H075	6F	FL074	27	109,15	107,78	115,0	80	-	26,4	40	11	2,10		
		28H075	6F	FL075	28	113,19	111,82	120,0	80	-	26,4	40	11	2,26		
		29H075	6F	FL075	29	117,23	115,86	120,0	80	-	26,4	40	11	2,49		
		30H075	6F	FL078	30	121,28	119,90	128,0	80	-	26,4	40	11	2,70		
		32H075	6F	FL080	32	129,36	127,99	135,0	80	-	26,4	40	11	2,85		
		33H075	6F	FL081	33	133,40	132,03	142,0	80	-	26,4	40	11	3,10		
		34H075	6F	FL081	34	137,45	136,07	142,0	80	-	26,4	40	11	3,30		
		35H075	6F	FL085	35	141,49	140,12	150,0	80	-	26,4	40	11	3,50		
		36H075	6F	FL085	36	145,53	144,16	150,0	80	-	26,4	40	11	3,65		
		38H075	6F	FL086	38	153,62	152,24	158,0	80	-	26,4	40	11	3,90		
		40H075	6F	FL090	40	161,70	160,33	168,0	80	-	26,4	40	11	4,23		
		42H075	6F	FL094	42	169,79	168,41	180,0	80	-	26,4	40	11	4,80		
		Ghisa / Cast iron / Grauguss Fonte / Hierro fundido	senza flangia / without flanges ohne Bordscheiben / sans flasques / sin tapetas	44H075	6WF	FL095	44	177,87	176,50	184,0	80	150	26,4	40	14	5,20
				45H075	6WF	FL096	45	181,91	180,54	192,0	80	154	26,4	40	14	5,45
				48H075	6WF	FL100	48	194,04	192,67	200,0	90	166	26,4	45	14	4,30
				49H075	6W	-	49	198,08	196,71	-	90	170	26,4	45	14	4,50
				50H075	6W	-	50	202,13	200,75	-	90	174	26,4	45	14	4,66

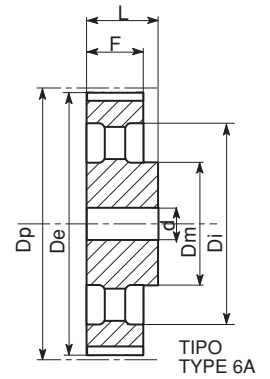
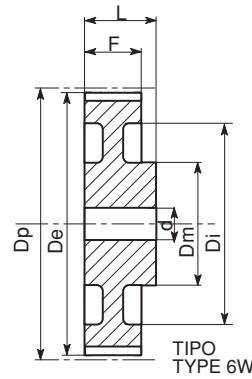
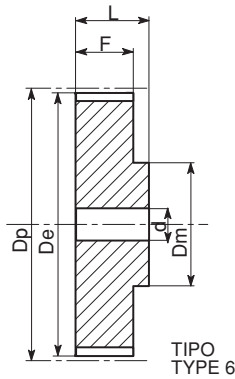
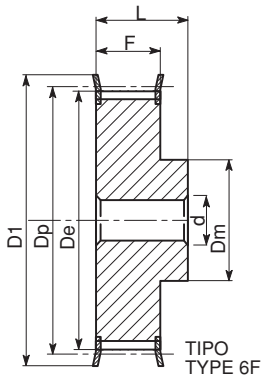

XXH 200 - 1" 1/4 (31,750 mm)

Caratteristiche Features Merkmale Características	Codice Code symbol Bezeichnung Code symbole Numero de fabrica	Cod.	Tipo Type Typ Type Tipo	Codice flangia Flange code Bordscheiben Typ Code flasque Código brida	N. denti N. of teeth Zähnezahl N. bre de dents Cantidad de dientes	Dp	De	Df	Dm	Di	F	L	Foro stock Stock bore Vorbohrung Alesage en stock Agujero de stock	Peso Weight / Gewicht Poids / Peso Kg	
Acciaio / Steel / Stahl Acier / Acero	con flangia / with flanges mit Bordscheiben avec flasques / con tapetas	18XXH200	XXH2018	6F	FL163	18	181,91	178,87	198,0	140	-	64,2	100	28	14,2
		19XXH200	XXH2019	6F	FL164	19	192,02	188,97	205,0	140	-	64,2	100	28	15,8
		20XXH200	XXH2020	6F	FL165	20	202,13	199,08	212,0	150	-	64,2	100	28	17,3
		21XXH200	XXH2021	6F	FL167	21	212,23	209,19	227,0	150	-	64,2	100	28	18,5
		22XXH200	XXH2022	6F	FL169	22	222,34	219,29	240,0	150	-	64,2	100	28	20,0
		24XXH200	XXH2024	6	-	24	242,55	239,50	-	150	-	64,2	100	28	23,6
Ghisa / Cast iron / Grauguss Fonte / Hierro fundido	senza flangia / without flanges ohne Bordscheiben / sans flasques sin tapetas	25XXH200	XXH2025	6W	-	25	252,66	249,61	-	150	196	64,2	100	28	18,0
		26XXH200	XXH2026	6W	-	26	262,76	259,79	-	150	207	64,2	100	28	20,0
		27XXH200	XXH2027	6W	-	27	272,87	269,82	-	150	216	64,2	100	28	24,0
		30XXH200	XXH2030	6W	-	30	303,19	300,14	-	150	247	64,2	100	28	26,0
		34XXH200	XXH2034	6W	-	34	343,62	340,57	-	150	287	64,2	100	28	31,8
		40XXH200	XXH2040	6W	-	40	404,25	401,21	-	150	348	64,2	100	28	43,0
		48XXH200	XXH2048	6W	-	48	485,10	482,06	-	175	429	64,2	100	32	60,4
		60XXH200	XXH2060	6A	-	60	606,38	603,33	-	175	547	64,2	120	32	100,0
		72XXH200	XXH2072	6A	-	72	727,66	724,61	-	175	668	64,2	120	38	130,0
		90XXH200	XXH2090	6A	-	90	909,57	906,52	-	175	850	64,2	120	38	156,0

XXH 300 - 1" 1/4 (31,750 mm)

Caratteristiche Features Merkmale Características	Codice Code symbol Bezeichnung Code symbole Numero de fabrica	Cod.	Tipo Type Typ Type Tipo	Codice flangia Flange code Bordscheiben Typ Code flasque Código brida	N. denti N. of teeth Zähnezahl N. bre de dents Cantidad de dientes	Dp	De	Df	Dm	Di	F	L	Foro stock Stock bore Vorbohrung Alesage en stock Agujero de stock	Peso Weight / Gewicht Poids / Peso Kg	
Acciaio / Steel / Stahl Acier / Acero	con flangia / with flanges mit Bordscheiben avec flasques / con tapetas	18XXH300	XXH30018	6F	FL163	18	181,91	178,87	198,0	140	-	91,4	110	28	16,0
		19XXH300	XXH30019	6F	FL164	19	192,02	188,97	205,0	140	-	91,4	110	28	18,4
		20XXH300	XXH30020	6F	FL165	20	202,13	199,08	212,0	150	-	91,4	110	28	20,4
		21XXH300	XXH30021	6F	FL167	21	212,23	209,19	227,0	150	-	91,4	110	28	22,0
		22XXH300	XXH30022	6F	FL169	22	222,34	219,29	240,0	150	-	91,4	110	28	25,0
		24XXH300	XXH30024	6	-	24	242,55	239,50	-	150	-	91,4	110	28	29,2
Ghisa / Cast iron / Grauguss Fonte / Hierro fundido	senza flangia / without flanges ohne Bordscheiben / sans flasques sin tapetas	25XXH300	XXH30025	6W	-	25	252,66	249,61	-	150	196	91,4	110	28	24,6
		26XXH300	XXH30026	6W	-	26	262,76	259,79	-	150	207	91,4	110	28	27,0
		27XXH300	XXH30027	6W	-	27	272,87	269,82	-	150	216	91,4	110	28	29,0
		30XXH300	XXH30030	6W	-	30	303,19	300,14	-	150	247	91,4	110	28	31,0
		34XXH300	XXH30034	6W	-	34	343,62	340,57	-	150	287	91,4	110	28	39,0
		40XXH300	XXH30040	6W	-	40	404,25	401,21	-	150	348	91,4	110	28	45,0
		48XXH300	XXH30048	6W	-	48	485,10	482,06	-	175	429	91,4	110	32	60,0
		60XXH300	XXH30060	6A	-	60	606,38	603,33	-	175	547	91,4	120	32	100,0
		72XXH300	XXH30072	6A	-	72	727,66	724,61	-	175	668	91,4	120	38	135,0
		90XXH300	XXH30090	6A	-	90	909,57	906,52	-	175	850	91,4	120	38	160,0

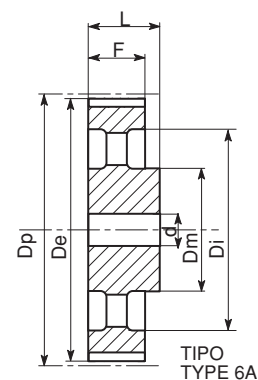
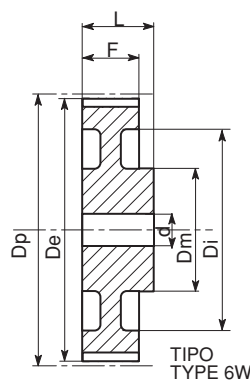
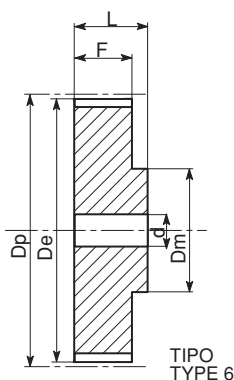
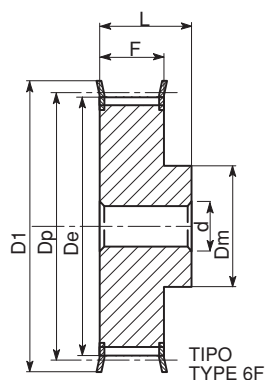

XXH 400 - 1" 1/4 (31,750 mm)

Caratteristiche Features Merkmale Características	Codice Code symbol Bezeichnung Code symbole Numero de fabrica	Cod.	Tipo Type Typ Type Tipo	Codice flangia Flange code Bordscheiben Typ Code flasque Código brida	N. denti N. of teeth Zähnezahl N. bre de dents Cantidad de dientes	Dp	De	Df	Dm	Di	F	L	Foro stock Stock bore Vorbohrung Alesage en stock Agujero de stock	Peso Weight / Gewicht Poids / Peso Kg	
Acciaio / Steel / Stahl Acier / Acero	con flangia / with flanges mit Bordscheiben avec flasques / con tapetas	18XXH400	XXH4018	6F	FL163	18	181,91	178,87	198,0	140	-	120,7	140	32	20,8
		19XXH400	XXH4019	6F	FL164	19	192,02	188,97	205,0	140	-	120,7	140	32	24,0
		20XXH400	XXH4020	6F	FL165	20	202,13	199,08	212,0	150	-	120,7	140	32	26,0
		21XXH400	XXH4021	6F	FL167	21	212,23	209,19	227,0	150	-	120,7	140	32	28,5
		22XXH400	XXH4022	6F	FL169	22	222,34	219,29	240,0	150	-	120,7	140	32	31,6
		24XXH400	XXH4024	6	-	24	242,55	239,50	-	150	-	120,7	140	32	35,0
Ghisa / Cast iron / Grauguss Fonte / Hierro fundido	senza flangia / without flanges ohne Bordscheiben / sans flasques sin tapetas	25XXH400	XXH4025	6W	-	25	252,66	249,61	-	150	196	120,7	140	32	28,0
		26XXH400	XXH4026	6W	-	26	262,76	259,79	-	150	207	120,7	140	32	32,4
		27XXH400	XXH4027	6W	-	27	272,87	269,82	-	150	216	120,7	140	32	34,0
		30XXH400	XXH4030	6W	-	30	303,19	300,14	-	185	247	120,7	140	32	36,0
		34XXH400	XXH4034	6W	-	34	343,62	340,57	-	185	287	120,7	140	32	47,6
		40XXH400	XXH4040	6W	-	40	404,25	401,21	-	185	348	120,7	140	32	65,0
		48XXH400	XXH4048	6W	-	48	485,10	482,06	-	185	429	120,7	140	38	80,5
		60XXH400	XXH4060	6A	-	60	606,38	603,33	-	185	547	120,7	140	38	108,0
		72XXH400	XXH4072	6A	-	72	727,66	724,61	-	220	668	120,7	140	38	140,0
		90XXH400	XXH4090	6A	-	90	909,57	906,52	-	220	850	120,7	140	38	170,0

XXH 500 - 1" 1/4 (31,750 mm)

Caratteristiche Features Merkmale Características	Codice Code symbol Bezeichnung Code symbole Numero de fabrica	Cod.	Tipo Type Typ Type Tipo	Codice flangia Flange code Bordscheiben Typ Code flasque Código brida	N. denti N. of teeth Zähnezahl N. bre de dents Cantidad de dientes	Dp	De	Df	Dm	Di	F	L	Foro stock Stock bore Vorbohrung Alesage en stock Agujero de stock	Peso Weight / Gewicht Poids / Peso Kg	
Acciaio / Steel / Stahl Acier / Acero	con flangia / with flanges mit Bordscheiben avec flasques / con tapetas	18XXH500	XXH5018	6F	FL163	18	181,91	178,87	198,0	140	—	145,3	168	32	24,0
		19XXH500	XXH5019	6F	FL164	19	192,02	188,97	205,0	140	—	145,3	168	32	28,0
		20XXH500	XXH5020	6F	FL165	20	202,13	199,08	212,0	150	—	145,3	168	32	31,4
		21XXH500	XXH5021	6F	FL167	21	212,23	209,19	227,0	150	—	145,3	168	32	34,0
		22XXH500	XXH5022	6F	FL169	22	222,34	219,29	240,0	150	—	145,3	168	32	38,3
		24XXH500	XXH5024	6	-	24	242,55	239,50	-	150	—	145,3	168	32	45,0
Ghisa / Cast iron / Grauguss Fonte / Hierro fundido	senza flangia / without flanges ohne Bordscheiben / sans flasques sin tapetas	25XXH500	XXH5025	6W	-	25	252,66	249,61	-	150	196	145,3	168	32	36,0
		26XXH500	XXH5026	6W	-	26	262,76	259,79	-	150	207	145,3	168	32	37,5
		27XXH500	XXH5027	6W	-	27	272,87	269,82	-	150	216	145,3	168	32	42,0
		30XXH500	XXH5030	6W	-	30	303,19	300,14	-	215	247	145,3	168	32	46,8
		34XXH500	XXH5034	6W	-	34	343,62	340,57	-	215	287	145,3	168	32	57,0
		40XXH500	XXH5040	6W	-	40	404,25	401,21	-	215	348	145,3	168	32	68,0
		48XXH500	XXH5048	6W	-	48	485,10	482,06	-	215	429	145,3	168	38	88,8
		60XXH500	XXH5060	6A	-	60	606,38	603,33	-	240	547	145,3	120	38	99,8
		72XXH500	XXH5072	6A	-	72	727,66	724,61	-	240	668	145,3	120	38	172,0
		90XXH500	XXH5090	6A	-	90	909,57	906,52	-	240	850	145,3	120	38	242,5

Le barre dentate XL e L sono costruite in acciaio C45E e in alluminio 6082 T6, adatte alla anodizzazione. Le barre MXL sono costruite solo in alluminio.

The timing bars XL and L are made of steel C45E and of aluminium 6082 T6, suitable for anodic treatment, whereas the bars MXL are made of aluminium only.

Die stangen XL und L sind aus stahl C45E und aluminium 6082 T6 geeignet fuer anodischen oxydation. Die stangen MXL werden nur aus aluminium gefertigt.

Les barreaux dentes XL et L sont fabriqués en acier C45E et en aluminium 6082 T6, apte au traitement anodi = que, tandis que les barreaux MXL ne sont fabriqués qu'en aluminium.

Las barras dentadas XL y L se construyen en acero C45E y en aluminio 6082 T6 para la oxidacion anodica, mientras que las barras MXL solo se fabrican en aluminio.

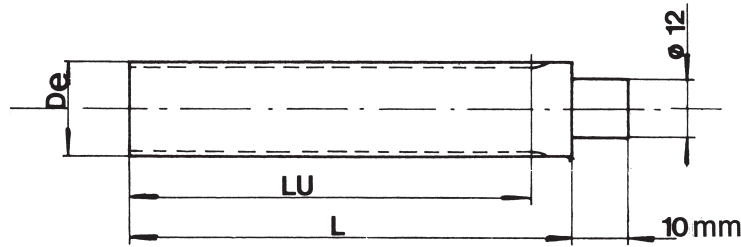

MXL - 0.080" (mm 2,032)

XL - 1/5" (mm 5,08)

L - 3/8" (mm 9,525)

Codice Code symbol Bezeichnung Code symbole Numero de fabrica	Nostro codice Our code Unser Code Notre code Nuestro codigo	N. denti N. of teeth Zähnezahl N. bre de dents Cantidad de dientes	De	LU	L	Codice Code symbol Bezeichnung Code symbole Numero de fabrica	Cod.		N. denti N. of teeth Zähnezahl N. bre de dents Cantidad de dientes	De	LU	L	Codice Code symbol Bezeichnung Code symbole Numero de fabrica	Cod.		N. denti N. of teeth Zähnezahl N. bre de dents Cantidad de dientes	De	LU	L
							AL	C45E						AL	C45E				
MXL 11	BMXL 011	11	6,60	50	75	XL 10	BXLA 010	BXLC 010	10	15,66	125	140	L 10	BOLA 010	BOLC 010	10	29,56	140	140
MXL 12	BMXL 012	12	7,26	50	75	XL 11	BXLA 011	BXLC 011	11	17,28	125	140	L 11	BOLA 011	BOLC 011	11	32,59	140	140
MXL 13	BMXL 013	13	7,90	50	75	XL 12	BXLA 012	BXLC 012	12	18,90	125	140	L 12	BOLA 012	BOLC 012	12	35,62	160	160
MXL 14	BMXL 014	14	8,56	50	75	XL 13	BXLA 013	BXLC 013	13	20,51	125	140	L 13	BOLA 013	BOLC 013	13	38,65	160	160
MXL 15	BMXL 015	15	9,19	50	75	XL 14	BXLA 014	BXLC 014	14	22,13	132	140	L 14	BOLA 014	BOLC 014	14	41,68	160	160
MXL 16	BMXL 016	16	9,83	50	75	XL 15	BXLA 015	BXLC 015	15	23,75	132	140	L 15	BOLA 015	BOLC 015	15	44,72	160	160
MXL 17	BMXL 017	17	10,49	50	75	XL 16	BXLA 016	BXLC 016	16	25,36	140	140	L 16	BOLA 016	BOLC 016	16	47,75	160	160
MXL 18	BMXL 018	18	11,12	50	75	XL 17	BXLA 017	BXLC 017	17	26,98	140	140	L 17	BOLA 017	BOLC 017	17	50,78	160	160
MXL 19	BMXL 019	19	11,78	90	120	XL 18	BXLA 018	BXLC 018	18	28,60	140	140	L 18	BOLA 018	BOLC 018	18	53,81	160	160
MXL 20	BMXL 020	20	12,42	90	120	XL 19	BXLA 019	BXLC 019	19	30,22	140	140	L 19	BOLA 019	BOLC 019	19	56,84	160	160
MXL 21	BMXL 021	21	13,08	90	120	XL 20	BXLA 020	BXLC 020	20	31,83	140	140	L 20	BOLA 020	BOLC 020	20	59,88	160	160
MXL 22	BMXL 022	22	13,72	125	140	XL 21	BXLA 021	BXLC 021	21	33,45	160	160	L 21	BOLA 021	BOLC 021	21	62,91	160	160
MXL 23	BMXL 023	23	14,38	125	140	XL 22	BXLA 022	BXLC 022	22	35,07	160	160	L 22	BOLA 022	BOLC 022	22	65,94	160	160
MXL 24	BMXL 024	24	15,01	125	140	XL 23	BXLA 023	BXLC 023	23	36,60	160	160	L 23	BOLA 023	BOLC 023	23	68,97	160	160
MXL 25	BMXL 025	25	15,67	125	140	XL 24	BXLA 024	BXLC 024	24	38,30	160	160	L 24	BOLA 024	BOLC 024	24	72,00	160	160
MXL 26	BMXL 026	26	16,31	125	140	XL 25	BXLA 025	BXLC 025	25	39,93	160	160	L 27	BOLA 027	BOLC 027	27	81,10	160	160
MXL 27	BMXL 027	27	16,94	125	140	XL 26	BXLA 026	BXLC 026	26	41,53	160	160	L 30	BOLA 030	BOLC 030	30	90,20	160	160
MXL 28	BMXL 028	28	16,70	125	140	XL 27	BXLA 027	BXLC 027	27	43,15	160	160							
MXL 29	BMXL 029	29	18,24	125	140	XL 28	BXLA 028	BXLC 028	28	44,77	160	160							
MXL 30	BMXL 030	30	18,90	125	140	XL 29	BXLA 029	BXLC 029	29	46,39	160	160							
MXL 32	BMXL 032	32	20,19	125	140	XL 30	BXLA 030	BXLC 030	30	48,00	160	160							
MXL 34	BMXL 034	34	21,49	125	140	XL 32	BXLA 032	BXLC 032	32	51,24	160	160							
MXL 35	BMXL 035	35	22,12	132	140	XL 34	BXLA 034	BXLC 034	34	54,47	160	160							
MXL 36	BMXL 036	36	22,78	132	140	XL 35	BXLA 035	BXLC 035	35	56,09	160	160							
MXL 38	BMXL 038	38	24,08	132	140	XL 36	BXLA 036	BXLC 036	36	57,70	160	160							
MXL 40	BMXL 040	40	25,37	132	140	XL 38	BXLA 038	BXLC 038	38	60,94	160	160							
MXL 42	BMXL 042	42	26,67	140	140	XL 40	BXLA 040	BXLC 040	40	64,17	160	160							
MXL 44	BMXL 044	44	27,94	140	140	XL 42	BXLA 042	BXLC 042	42	67,41	160	160							
MXL 45	BMXL 045	45	28,60	140	140	XL 44	BXLA 044	BXLC 044	44	70,64	160	160							
MXL 48	BMXL 048	48	30,53	140	140	XL 45	BXLA 045	BXLC 045	45	72,26	160	160							
MXL 50	BMXL 050	50	31,83	140	140	XL 48	BXLA 048	BXLC 048	48	77,11	160	160							
MXL 60	BMXL 060	60	38,30	160	160	XL 50	BXLA 050	BXLC 050	50	80,33	160	160							
MXL 64	BMXL 064	64	40,89	160	160	XL 60	BXLA 060	BXLC 060	60	96,51	160	160							
MXL 65	BMXL 065	65	41,53	160	160	XL 64	BXLA 064	BXLC 064	64	102,95	160	160							
MXL 70	BMXL 070	70	44,78	160	160	XL 65	BXLA 065	BXLC 065	65	104,56	160	160							
MXL 72	BMXL 072	72	46,05	160	160	XL 70	BXLA 070	BXLC 070	70	112,68	160	160							
MXL 75	BMXL 075	75	48,01	160	160	XL 72	BXLA 072	BXLA 072	72	115,92	160	160							
MXL 90	BMXL 090	90	57,71	160	160														
MXL 110	BMXL 110	110	70,64	160	160														