

GIUNTI AD INNESTO RAPIDO E PISTOLE AD ARIA

AUTOMATIC QUICK COUPLINGS AND BLOW GUNS

SCHNELLVERSCHLUSS-KUPPLUNGEN UND BLASPISTOLEN

COUPLEURS AUTOMATIQUES ET SOUFFLETES

ENCHUFES RÁPIDOS Y PISTOLAS DE AIRE

CONEXÕES DE ENGATE RÁPIDO E PISTOLAS DE AR



Serie Quick Couplings

Prese ad Innesto Rapido - Quick Couplings - Schnellverschluss Kupplungen
 Coupleurs Automatiques - Enchufes Rápidos - Conexões de Engate Rápido



Prese di Sicurezza ad Innesto Rapido - Safety Quick Couplings - Kupplungen Sicherheit - Coupleurs de Sécurité
 Enchufes de Seguridad - Conexões de Segurança



Giunti ad Innesto Rapido per Raffreddamento Stampi - Quick Couplings for Molding Cooling - Schnellkupplungen Für Spritzgussanwendungen
 Coupleurs pour Moulés D'injection - Enchufes Rápidos para Refrigeración de Moldes - Conexões de Engate Rápido para Resfriamento de Moldes



Pistole di Soffiaggio - Blow Guns - Blaspistolen - Soufflettes - Pistolas Sopladoras - Pistola de Ar

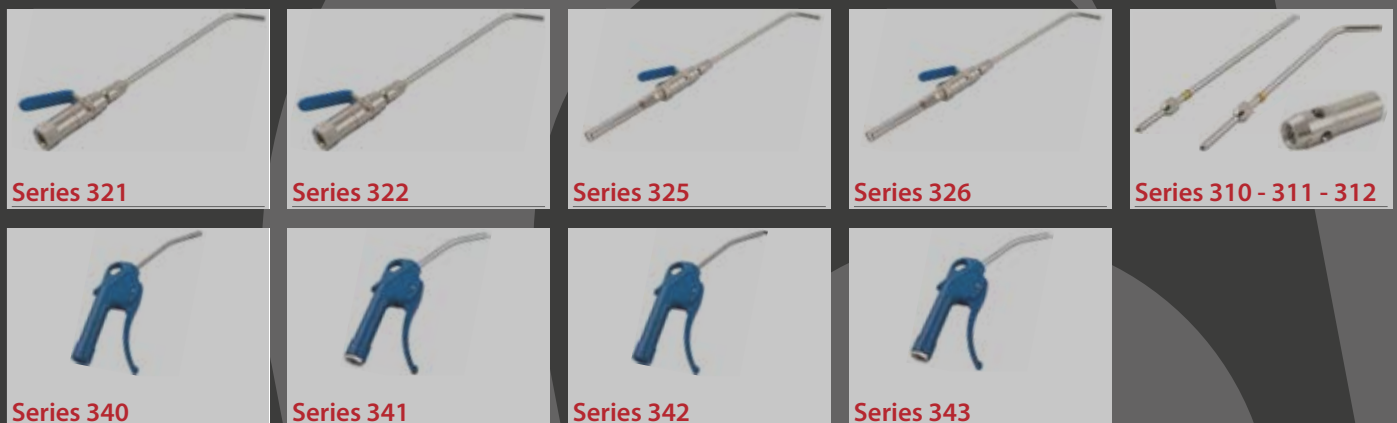

PLUG PROFILE 1:1	STANDARD	SERIE PLUG	STANDARD COUPLINGS	MULTI COUPLINGS	SERIE SAFETY	SERIE INOX	
	DN 5	MIGNON	210	110			
	DN 5	MIGNON DOUBLE SHUT OFF	280	180			
	DN 2.5	UNI-ISO 6150-A6	200	100			
	DN 5.5	UNI-ISO 6150-B12 INDUSTRIAL 1/4	220	120	190	620	
	DN 9	UNI-ISO 6150-B15 INDUSTRIAL 3/8	230	130	720		
	DN 12	UNI-ISO 6150-B17 INDUSTRIAL 1/2	810	710			
	DN 5.5	UNI-ISO 6150-C10	240	140			
	DN 7.5 - 7.8	EUROPEAN	260 63260	160	190	660	63190
	DN 10	EUROPEAN DN 10	820	720			
	DN 5.5	SWISS	270	170	190	670	
	DN 7.5	JAPANESE	500	400			
	DN 5	ITALIAN	250	120	190	650	
	DN 2.7	MINI	800	700			
	DN 8	FRENCH	510	410			
	DN 12	FRENCH	520	420			
	DN 6	INTERNATIONAL	530	430			
	DN 9	INTERNATIONAL	540	440			
	DN 6	EUROPEAN	560	460			
	DN 9	EUROPEAN	570	470			

ARIA - AIR - LUFT - AIR - AIRE - AR

ACQUA - WATER - WASSER - EAU - AGUA - ÁGUA
 OLIO - OIL - ÖL - HUILE - ACEITE - ÓLEO

INTERCAMBIABILITÀ - INTERCHANGE - AUSTAUSCHBARKEIT - INTERCHANGEABILITÉ - INTERCAMBIABILIDAD - INTERCAMBIABILIDADE

RECTUS/LEGRIS PARKER 21/90	CAMOZZI 5050 - 5150	CEJN 220		FESTO KD - KS 3	
RECTUS/PARKER 21/90	CAMOZZI 5050 - 5150	CEJN 200			
				FESTO KD - KS 2	
RECTUS/LEGRIS 23/24 PARKER 20/30 - 1/4 TEMA 1400	HANSEN 3000	CEJN 310	INDUSTRIAL 1/4	GROMELLE 600	US - MIL SPEC C-4109
RECTUS/LEGRIS 30 PARKER 30 - 3/8	HANSEN 4000	CEJN 430	INDUSTRIAL 3/8	GROMELLE 900	US - MIL SPEC C-4109
RECTUS 37	HANSEN 5000	CEJN 550		GROMELLE 1300	US - MIL SPEC C-4109
RECTUS/LEGRIS 18					
RECTUS/LEGRIS 25/26/1600/1625 TEMA 1600	CAMOZZI 5080 - 5180	CEJN 320		FESTO KD - KS 6 KD - KS 4	
RECTUS/LEGRIS 27		CEJN 410			
RECTUS/LEGRIS 14/22 PARKER 50	HANSEN 210	CEJN 300		ARO 210	
RECTUS/LEGRIS 13	SMC KK130	CEJN 315	NITTO KOHKI 200		
RECTUS/LEGRIS PARKER 20/91				FESTO KD - KS 2	
RECTUS 608					
RECTUS 612					
RECTUS 86	DME 1/4				
RECTUS 87	DME 3/8				
RECTUS 10	HASCO Z80/811HT/9 [Øe 9]	CEJN 220 - 221 - 225			
RECTUS 11	HASCO Z80/811HT/13 [Øe 13.5]				

ONE TOUCH



Connect the plug

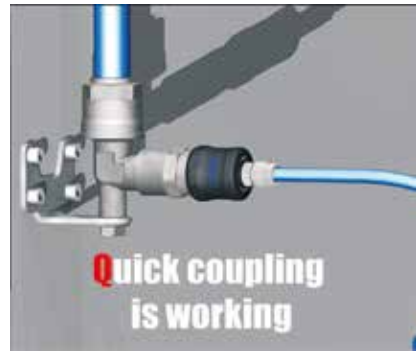

Quick coupling is working



Push the sleeve ahead and leave the hand



Air is exhausting completely



Remove the plug

Serie 600 - Safety Quick Couplings



CARATTERISTICHE TECNICHE
 TECHNICAL CHARACTERISTICS
 TECHNISCHE ANGABEN
 CARACTÉRISTIQUES TECHNIQUES
 CARACTERÍSTICAS TÉCNICAS
 CARACTERÍSTICAS TÉCNICAS



Norma di Riferimento
 Reference standard
 Entspricht der Norm
 Norme de référence
 Normativa de referencia
 Norma de referência

1907/2006 REACH ✓	2011/65/CE RoHS ✓
PED 2014/68/UE	SILICON FREE
ISO 4414	

CONSIGLIATA CON INNESTI ACCIAIO
 ADVISE WITH STEEL PLUG
 EMPFOHLENE STECKER AUS STAHL
 EMBOUT RECOMMANDÉE EN ACIER
 ACONSEJADOS CON ADAPT EN ACERO
 ACONSELHADA COM PLUG EM AÇO

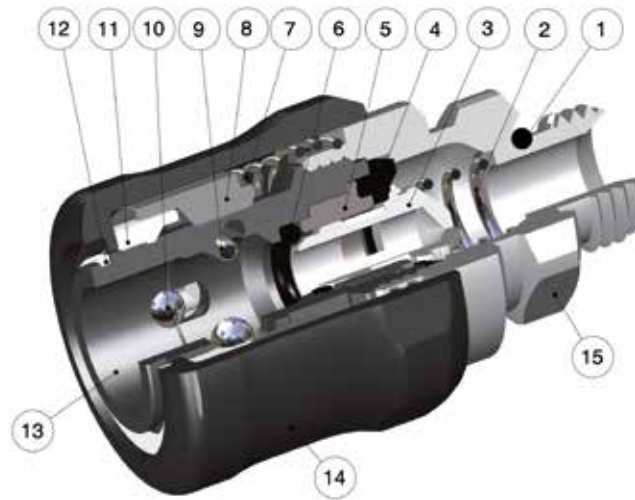

Materiali e Componenti	IT	Component Parts and Materials	GB	Komponenten und Materialien	DE
1 Guarnizione O-Ring in NBR 70		1 NBR 70 O-ring		1 O-Ring NBR 70	
2 Molla contrasto otturatore in acciaio INOX AISI 302		2 INOX steel AISI 302 shutter thrust spring		2 Verschlussfeder Edelstahl AISI 302	
3 Otturatore in ottone nichelato		3 Nickel-plated brass shutter		3 Verschluss Messing vernickelt	
4 Guarnizione in NBR 70		4 NBR 70 seal		4 Dichtung NBR 70	
5 Anello in ottone nichelato		5 Nickel-plated brass ring		5 Führungsring Messing vernickelt	
6 Guarnizione O-Ring in NBR 70		6 NBR 70 O-ring		6 O-Ring NBR 70	
7 Molla contrasto ghiera in acciaio INOX AISI 302		7 INOX steel AISI 302 ring nut thrust spring		7 Entriegelungsfeder Edelstahl AISI 302	
8 Anello trascinamento rullini in tecnopolimero		8 Technopolymeric trailing pins ring		8 Hinterer Führungsring Technopolymer	
9 Spina in acciaio INOX AISI 420		9 INOX steel AISI 420 pin		9 Stift Edelstahl AISI 420	
10 Sfera in acciaio INOX AISI 420		10 INOX steel AISI 420 ball		10 Kugel Edelstahl AISI 420	
11 Anello contenimento sfera in acciaio INOX AISI 303		11 INOX steel AISI 303 restraining balls ring		11 Kugel Führungsring Edelstahl AISI 303	
12 Seeger in acciaio INOX AISI 302		12 INOX steel AISI 302 seeger		12 Seegerring Edelstahl AISI 302	
13 Corpo in tecnopolimero		13 Technopolymeric Body		13 Körper Technopolymer	
14 Ghiera in tecnopolimero		14 Technopolymeric sleeve		14 Entriegelungshülse Technopolymer	
15 Attacco terminale in ottone nichelato		15 Nickel-plated brass coupling back part		15 Einschraubkörper Messing vernickelt	

Matériaux et Composants	FR	Materiales y Componentes	ES	Materiali e Componentes	PT
1 Joint torrique: NBR 70		1 Junta tórica en NBR 70		1 Vedação O-Ring em NBR 70	
2 Ressort de bague: acier inoxydable AISI 302		2 Muelle empuje obturador en acero INOX AISI 302		2 Mola do obturador em aço INOX AISI 302	
3 Clapet: laiton nickelé		3 Obturador en latón niquelado		3 Obturador em Latão em Latão Niquelado	
4 Joint: NBR 70		4 Junta en NBR 70		4 Vedação em NBR 70	
5 Bague de guidage: laiton nickelé		5 Anillo en latón niquelado		5 Anel em Latão Niquelado	
6 Joint torrique: NBR 70		6 Junta tórica en NBR 70		6 Vedação O-Ring em NBR 70	
7 Ressort: acier inoxydable AISI 302		7 Muelle empuje tuerca en acero INOX AISI 302		7 Mola da porca em aço INOX AISI 302	
8 Bague: technopolymère		8 Anillo deslizamiento perno en tecnopolímero		8 Anello trascinamento rullini in tecnopolimero	
9 Goupille: acier inoxydable AISI 420		9 Perno en acero INOX AISI 420		9 Pino em aço INOX AISI 420	
10 Bille: acier inoxydable AISI 420		10 Esfera en acero INOX AISI 420		10 Esfera em aço INOX AISI 420	
11 Cage à bille: acier inoxydable AISI 303		11 Anillo contención esfera en acero INOX AISI 303		11 Anel de contenção da esfera em aço INOX AISI 303	
12 Circlips: acier inoxydable AISI 302		12 Seeger en acero INOX AISI 302		12 Anel de retenção tipo Seeger em aço INOX AISI 302	
13 Corps: technopolymère		13 Cuerpo en tecnopolímero		13 Corpo em tecnopolímero	
14 Guidage: technopolymère		14 Tuerca en tecnopolímero		14 Porca em tecnopolímero	
15 Corps: laiton nickelé		15 Terminal en latón niquelado		15 Conexão terminal em Latão Niquelado	



Pressione d'esercizio

Working Pressures

Betriebsdruck

Pression de service

Presión de Ejercicio

Pressão de Trabalho

-0.99 bar (-0.099 MPa)

15 bar (1.5 MPa)



Temperature

Temperatures

Temperatur

Températures

Temperaturas

Temperaturas

- 20 °C

+ 80 °C



Fluidi compatibili

Aria compressa

Fluids

Compressed air

Geeignete Medien

Druckluft

Fluides compatibles

Air comprimé

Fluidos compatibles

Aire comprimido

Fluidos compatíveis

Ar comprimido



Portata

NI/min

Flow Rate

Durchflusswerte

Débit

Caudal de Flujo

Vazão

Innesto Plug Stecker Embout Adaptador Plug	6 bar Δ 1	6 bar Δ 0.5	6 bar Δ 0*
220 AC	950	700	1400
250 AC	850	700	1170
260 AC	1300	1050	1830
270 AC	1000	750	1350

* Scarico libero - Exhaust Free - Kostenlose Auspuff - Échappement libre - Escape Libre - Descarga livre.



Filettatura

IT

Gas cilindrica conforme ISO 228 Classe A.

Threads

GB

Parallel gas in conformity with ISO 228 Class A.

Gewindearten

DE

Zylindrisches Gewinde nach Norm ISO 228 Classe A.

Filetages

FR

Filetage cylindrique conforme: ISO 228 Class A.

Roscas

ES

Gas cilindrica conforme ISO 228 Clase A.

Roscas

PT

Gas paralela conforme ISO 228 Classe A.

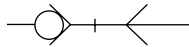

SUVA APPROVED

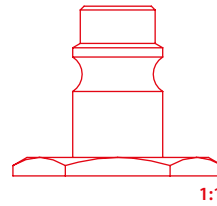

661

PRESA CON ATTACCO MASCHIO

MALE SOCKET
 VERSCHLUSS-KUPPLUNG MIT AUSSENGEWINDE
 COUPLEUR MÂLE
 ENCHUFE MACHO
 SOQUETE COM ROSCA MACHO

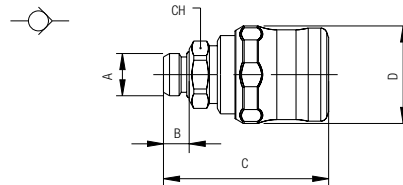

Code	A	B	C	D	CH	Pack.
00661 00 001	1/4	8	51	30.5	19	10
00661 00 002	3/8	9	51.5	30.5	20	10
00661 00 003	1/2	10	52.5	30.5	25	10

662

PRESA CON ATTACCO FEMMINA

FEMALE SOCKET
 VERSCHLUSS-KUPPLUNG MIT INNENGEWINDE
 COUPLEUR FEMELLE
 ENCHUFE HEMBRA
 SOQUETE COM ROSCA FÊMEA

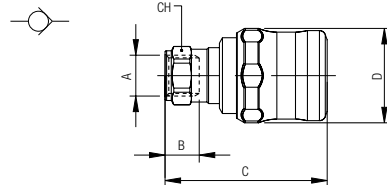

Code	A	B	C	D	CH	Pack.
00662 00 001	1/4	11	51.5	30.5	17	10
00662 00 002	3/8	12	52.5	30.5	20	10
00662 00 003	1/2	15	55.5	30.5	24	10

664

PRESA CON ATTACCO A CALZAMENTO

COMPRESSION SOCKET
 VERSCHLUSS-KUPPLUNG MIT ÜBERWURFVERSCHRAUBUNG
 COUPLEUR RACCORD À COIFFE
 ENCHUFE TUBO
 SOQUETE COM CONEXÃO PUSH-ON

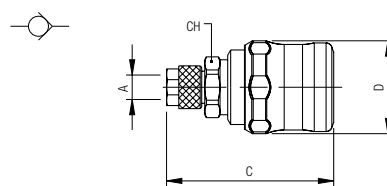

Code	A	B	C	D	CH	Pack.
00664 00 001	6/4	-	54.5	30.5	18	10
00664 00 002	8/6	-	54	30.5	18	10
00664 00 005	10/6.5	-	57	30.5	18	10
00664 00 003	10/8	-	56	30.5	18	10
00664 00 006	12/8	-	57.5	30.5	18	10
00664 00 004	12/10	-	56.5	30.5	18	10

665

PRESA CON PORTAGOMMA A RESCA

SOCKET WITH REST FOR RUBBER HOSE
 VERSCHLUSS-KUPPLUNG MIT SCHLAUCHTÜLLE
 COUPLEUR À DOUILLE ANNELÉE POUR TUBE
 ENCHUFE ESPIGA
 SOQUETE COM ESPIGÃO PARA MANGUEIRA DE BORRACHA

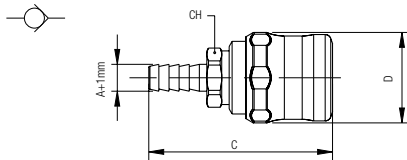

Code	A	B	C	D	CH	Pack.
00665 00 001	6	-	61	30.5	18	10
00665 00 002	8	-	61	30.5	18	10
00665 00 003	10	-	61	30.5	18	10
00665 00 004	12	-	61	30.5	18	10

261AC

INNESTO IN ACCIAIO CON ATTACCO MASCHIO

STEEL MALE PLUG
 STECKER MIT AUSSENGEWINDE AUS STAHL
 EMBOUT MÂLE EN ACIER
 ADAPTADOR EN ACERO MACHO
 PLUG EM AÇO COM ROSCA MACHO

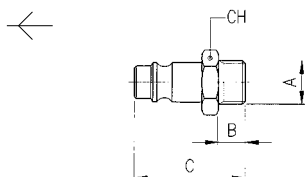

Code	A	B	C	D	CH	Pack.
261AC 00 51 03 ZI	1/4	8	33	-	17	10
261AC 00 51 04 ZI	3/8	9	34	-	19	10
261AC 00 51 05 ZI	1/2	10	35.5	-	24	10

ACCIAIO INDURITO
 HARDENED STEEL
 GEHÄRTETEM STAHL
 ACIER TREMPÉ
 ACERO CURTIDO
 AÇO ENDURECIDO

262AC

INNESTO IN ACCIAIO CON ATTACCO FEMMINA

STEEL FEMALE PLUG
 STECKER MIT INNENGEWINDE AUS STAHL
 EMBOUT FEMELLE EN ACIER
 ADAPTADOR EN ACERO HEMBRA
 PLUG EM AÇO COM ROSCA FÊMEA

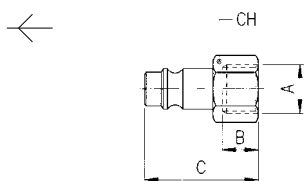

Code	A	B	C	D	CH	Pack.
262AC 00 51 03 ZI	1/4	11	33	-	17	10
262AC 00 51 04 ZI	3/8	11.5	33.5	-	19	10
262AC 00 51 05 ZI	1/2	14	36	-	24	10

ACCIAIO INDURITO
 HARDENED STEEL
 GEHÄRTETEM STAHL
 ACIER TREMPÉ
 ACERO CURTIDO
 AÇO ENDURECIDO

265AC

INNESTO IN ACCIAIO CON PORTAGOMMA A RESCA

STEEL PLUG WITH REST FOR RUBBER HOSE
 STECKER MIT SCHLAUCHTÜLLE AUS STAHL
 EMBOUT À DOUILLE ANNELÉE POUR TUBE EN ACIER
 ADAPTADOR EN ACERO ESPIGA
 PLUG EM AÇO COM ESPIGÃO PARA TUBO DE BORRACHA

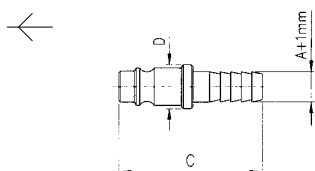

Code	A	B	C	D	CH	Pack.
265AC 00 51 X4 ZI	6	-	39.5	12	-	10
265AC 00 51 X7 ZI	8	-	39.5	12	-	10
265AC 00 51 X9 ZI	10	-	42.5	14	-	10
265AC 00 51 Y1 ZI	12	-	42.5	16	-	10

ACCIAIO INDURITO
 HARDENED STEEL
 GEHÄRTETEM STAHL
 ACIER TREMPÉ
 ACERO CURTIDO
 AÇO ENDURECIDO

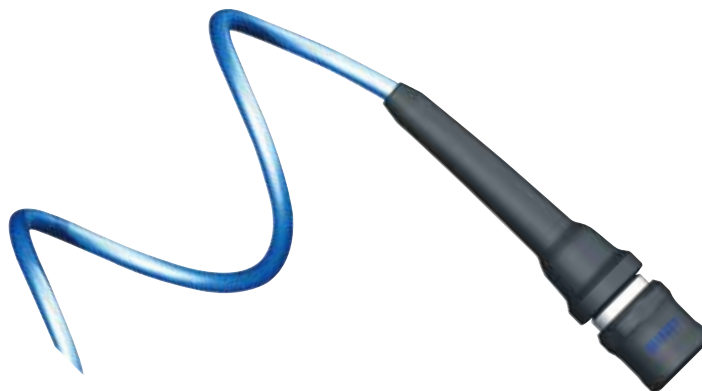

Applicazione Articolo 628

IT

L'articolo 628 è particolarmente indicato per le prese con terminale portagomma a resca e attacco a calzamento.

Articoli con attacco a calzamento:
624 - 654 - 664 - 674

Articoli con portagomma a resca:
625 - 655 - 665 - 675

Item 628 Applications

GB

628 Item is particularly indicated for Socket with rest for rubber tube and compression socket.

Items with compression socket:
624 - 654 - 664 - 674

Items with rest for rubber tube:
625 - 655 - 665 - 675

Anwendung des Artikels 628

DE

Der Artikel 628 ist besonders geeignet für Kupplungen mit Überwurfverschraubungen und Schlauchtüllen.

Artikel mit Überwurfverschraubungen:
624 - 654 - 664 - 674

Artikel mit Schlauchtüllen:
625 - 655 - 665 - 675

Applications de l'Article 628

FR

L'article 628 est indiqué pour les coupleurs à raccord à coiffe et à douille annelée.

Articles à raccord à coiffe:
624 - 654 - 664 - 674

Articles à raccord à douille:
625 - 655 - 665 - 675

Aplicación Artículo 628

ES

El artículo 628 es particularmente indicado para los enchufes espiga y para los enchufes tubo.

Artículos con conexión para tubo:
624 - 654 - 664 - 674

Artículos con conexión espiga:
625 - 655 - 665 - 675

Aplicação do Produto de cód. 628

PT

O produto cód. 628 é particularmente indicado para os soquetes com terminais do tipo espigão para tubo de borracha e conexão push-on.

Produtos com conexão push-on:
624 - 654 - 664 - 674

Produtos com espigão para tubo de borracha:
625 - 655 - 665 - 675

628

PROTEZIONE PRESA IN EPDM

EPDM SOCKET PROTECTION

KUPPLUNGSSCHUTZ IN EPDM

PROTECTION POUR COUPLEUR EN EPDM

PROTECCIÓN ENCHUFE EN EPDM

CAPA DE PROTEÇÃO PARA SOQUETE EM EPDM

Code	A	C	D	Pack.
00628 00 20 00 00	*6 - 8 - 10 - 12	105	30.5	10

* Tagliare la protezione in corrispondenza della scritta indicante la misura del diametro esterno del tubo utilizzato.

Cut the protection on external tube diameter sign.

Schneiden Sie das Schutzrohr gemäß den Markierungen auf den gewünschten Durchmesser.

Couper le tube de protection sur la marque en fonction du diamètre désiré.

Cortar la protección en función de la escritura que indica el diámetro externo del tubo utilizado.

Corte a proteção na marcação correspondente ao diâmetro externo do tubo a ser utilizado.

