

GIUNTI AD INNESTO RAPIDO E PISTOLE AD ARIA

AUTOMATIC QUICK COUPLINGS AND BLOW GUNS

SCHNELLVERSCHLUSS-KUPPLUNGEN UND BLASPISTOLEN

COUPLEURS AUTOMATIQUES ET SOUFFLETES

ENCHUFES RÁPIDOS Y PISTOLAS DE AIRE

CONEXÕES DE ENGATE RÁPIDO E PISTOLAS DE AR



Serie Quick Couplings

Prese ad Innesto Rapido - Quick Couplings - Schnellverschluss Kupplungen
 Coupleurs Automatiques - Enchufes Rápidos - Conexões de Engate Rápido



Prese di Sicurezza ad Innesto Rapido - Safety Quick Couplings - Kupplungen Sicherheit - Coupleurs de Sécurité
 Enchufes de Seguridad - Conexões de Segurança









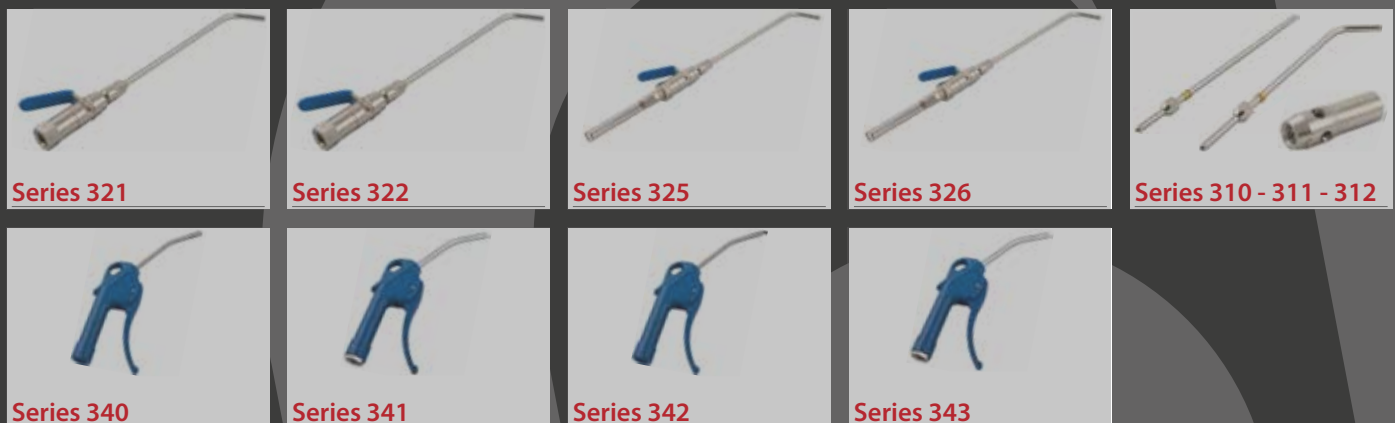

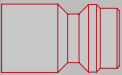
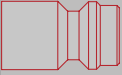
Giunti ad Innesto Rapido per Raffreddamento Stampi - Quick Couplings for Molding Cooling - Schnellkupplungen Für Spritzgussanwendungen
 Coupleurs pour Moulés D'injection - Enchufes Rápidos para Refrigeración de Moldes - Conexões de Engate Rápido para Resfriamento de Moldes

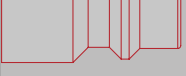
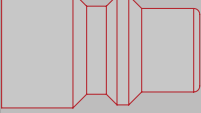
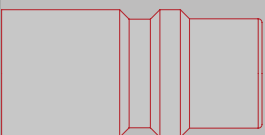
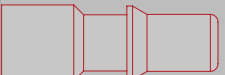
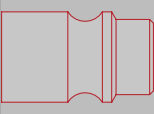
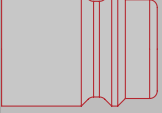
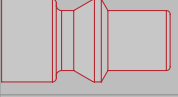
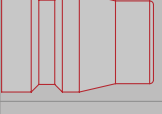

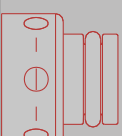
Pistole di Soffiaggio - Blow Guns - Blaspistolen - Soufflettes - Pistolas Sopladoras - Pistola de Ar

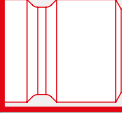

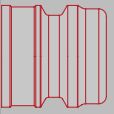
PLUG PROFILE 1:1	STANDARD	SERIE PLUG	STANDARD COUPLINGS	MULTI COUPLINGS	SERIE SAFETY	SERIE INOX
	DN 5	MIGNON	210	110		
	DN 5	MIGNON DOUBLE SHUT OFF	280	180		
	DN 2.5	UNI-ISO 6150-A6	200	100		
	DN 5.5	UNI-ISO 6150-B12 INDUSTRIAL 1/4	220	120	190	620
	DN 9	UNI-ISO 6150-B15 INDUSTRIAL 3/8	230	130	720	
	DN 12	UNI-ISO 6150-B17 INDUSTRIAL 1/2	810	710		
	DN 5.5	UNI-ISO 6150-C10	240	140		
	DN 7.5 - 7.8	EUROPEAN	260 63260	160	190	660 63190
	DN 10	EUROPEAN DN 10	820	720		
	DN 5.5	SWISS	270	170	190	670
	DN 7.5	JAPANESE	500	400		
	DN 5	ITALIAN	250	120	190	650
	DN 2.7	MINI	800	700		
	DN 8	FRENCH	510	410		
	DN 12	FRENCH	520	420		
	DN 6	INTERNATIONAL	530	430		
	DN 9	INTERNATIONAL	540	440		
	DN 6	EUROPEAN	560	460		
	DN 9	EUROPEAN	570	470		

ARIA - AIR - LUFT - AIR - AIRE - AR

ACQUA - WATER - WASSER - EAU - AGUA - ÁGUA
 OLIO - OIL - ÖL - HUILE - ACEITE - ÓLEO

INTERCAMBIABILITÀ - INTERCHANGE - AUSTAUSCHBARKEIT - INTERCHANGEABILITÉ - INTERCAMBIABILIDAD - INTERCAMBIABILIDADE

RECTUS/LEGRIS PARKER 21/90	CAMOZZI 5050 - 5150	CEJN 220		FESTO KD - KS 3	
RECTUS/PARKER 21/90	CAMOZZI 5050 - 5150	CEJN 200			
				FESTO KD - KS 2	
RECTUS/LEGRIS 23/24 PARKER 20/30 - 1/4 TEMA 1400	HANSEN 3000	CEJN 310	INDUSTRIAL 1/4	GROMELLE 600	US - MIL SPEC C-4109
RECTUS/LEGRIS 30 PARKER 30 - 3/8	HANSEN 4000	CEJN 430	INDUSTRIAL 3/8	GROMELLE 900	US - MIL SPEC C-4109
RECTUS 37	HANSEN 5000	CEJN 550		GROMELLE 1300	US - MIL SPEC C-4109
RECTUS/LEGRIS 18					
RECTUS/LEGRIS 25/26/1600/1625 TEMA 1600	CAMOZZI 5080 - 5180	CEJN 320		FESTO KD - KS 6 KD - KS 4	
RECTUS/LEGRIS 27		CEJN 410			
RECTUS/LEGRIS 14/22 PARKER 50	HANSEN 210	CEJN 300		ARO 210	
RECTUS/LEGRIS 13	SMC KK130	CEJN 315	NITTO KOHKI 200		
RECTUS/LEGRIS PARKER 20/91				FESTO KD - KS 2	
RECTUS 608					
RECTUS 612					
RECTUS 86	DME 1/4				
RECTUS 87	DME 3/8				
RECTUS 10	HASCO Z80/811HT/9 [Øe 9]	CEJN 220 - 221 - 225			
RECTUS 11	HASCO Z80/811HT/13 [Øe 13.5]				

GIUNTI AD INNESTO RAPIDO PER RAFFREDDAMENTO STAMPI

QUICK COUPLINGS FOR MOLDING COOLING

SCHNELLKUPPLUNGEN FÜR SPRITZGUSSANWENDUNGEN

COUPLEURS POUR MOULES D'INJECTION

ENCHUFES RÁPIDOS PARA REFRIGERACIÓN DE MOLDES

CONEXÃO DE ENGATE RÁPIDO PARA RESFRIAMENTO DE MOLDES



Serie International - European

SERIE 430-440 INTERNATIONAL PROFILE



CARATTERISTICHE TECNICHE
 TECHNICAL CHARACTERISTICS
 TECHNISCHE ANGABEN
 CARACTÉRISTIQUES TECHNIQUES
 CARACTERÍSTICAS TÉCNICAS
 CARACTERÍSTICAS TÉCNICAS



Norma di Riferimento

- Reference standard
- Entspricht der Norm
- Norme de référence
- Normativa de referencia
- Norma de referência

1907/2006
 REACH ✓

2011/65/CE
 RoHS ✓

PED
 2014/68/UE

SILICON
 FREE

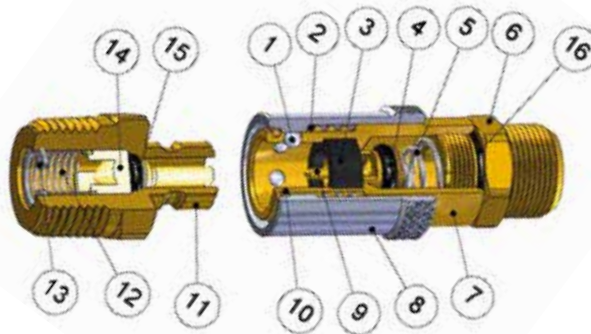

VERSIONE OTTURATA E NON OTTURATA
 BLOCKED AND NOT BLOCKED VERSION
 VERSION GESPERRT ODER NICHT GESPERRT
 VERSION AVEC OU SANS CLAPET
 VERSIÓN OBTURADA Y NO OBTURADA
 VERSÃO COM E SEM RETENÇÃO



INTERNATIONAL

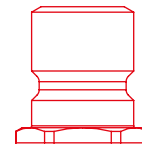

INTERNATIONAL



Materiali e Componenti

IT

- 1 Sfera in acciaio AISI 420
- 2 Molla ghiera in acciaio AISI 302
- 3 Guarnizione in FKM
- 4 Guarnizione O-Ring in FKM
- 5 Molla otturatore in acciaio AISI 302
- 6 Attacco terminale in ottone
- 7 Presa in ottone
- 8 Ghiera in ottone nichelato / Giallo
- 9 Otturatore in ottone
- 10 Seeger in bronzo / ottone
- 11 Innesto in ottone
- 12 Molla otturatore in acciaio AISI 302
- 13 Seeger in acciaio AISI 420
- 14 Otturatore in ottone
- 15 Guarnizione O-Ring in FKM
- 16 Guarnizione

Component Parts and Materials

GB

- 1 Steel AISI 420 ball
- 2 Steel AISI 302 ring nut spring
- 3 FKM seal
- 4 FKM O-Ring seal
- 5 Steel AISI 302 shutter spring
- 6 Brass coupling back part
- 7 Brass socket
- 8 Nickel-plated / Yellow brass sleeve
- 9 Brass shutter
- 10 Bronze / Brass seeger
- 11 Brass plug outline
- 12 Steel AISI 302 shutter spring
- 14 Steel AISI 420 seeger
- 13 Brass shutter
- 15 FKM O-Ring seal
- 16 Seal

Komponenten und Materialien

DE

- 1 Kugel Edelstahl AISI 420
- 2 Entriegelungsfeder Edelstahl AISI 302
- 3 Dichtung FKM
- 4 O-Ring FKM
- 5 Verschlussfeder Edelstahl AISI 302
- 6 Einschraubkörper Messing
- 7 Büchse Messing
- 8 Entriegelungshülse Messing vernickelt
- 9 Verschluss Messing
- 10 Seegerring Bronze/Messing
- 11 Stecker Messing
- 12 Verschlussfeder Edelstahl AISI 302
- 13 Seegerring Edelstahl AISI 302
- 14 Verschluss Messing
- 15 O-Ring FKM
- 16 O-Ring

Matériaux et Composants

FR

- 1 Bille: acier inoxydable AISI 420
- 2 Ressort: acier inoxydable AISI 302
- 3 Joint: FKM
- 4 Joint torique: FKM
- 5 Ressort: acier inoxydable AISI 302
- 6 Corps: laiton
- 7 Douille: laiton
- 8 Douille: laiton nickelé
- 9 Clapet: laiton
- 10 Circlips: bronze / laiton
- 11 Embout: laiton
- 12 Ressort de clapet: acier inoxydable AISI 302
- 13 Circlips: acier inoxydable AISI 302
- 14 Clapet: laiton
- 15 Joint torique: FKM
- 16 Joint

Materiales y Componentes

ES

- 1 Esfera en acero AISI 420
- 2 Muelle tuerca en acero AISI 302
- 3 Junta en FKM
- 4 Junta tórica en FKM
- 5 Muelle obturador en acero AISI 302
- 6 Conexión terminal en latón
- 7 Enchufe en latón
- 8 Tuerca en latón niquelado
- 9 Obturador en latón
- 10 Seeger en bronce/latón
- 11 Adaptador en latón
- 12 Muelle obturador en acero AISI 302
- 13 Obturador en latón
- 14 Seeger en acero AISI 302
- 15 Junta tórica en FKM
- 16 Junta

Materiais e Componentes

PT

- 1 Esfera em aço AISI 420
- 2 Mola da porca em aço AISI 302
- 3 Vedação em FKM
- 4 Vedação O-Ring em FKM
- 5 Mola do obturador em aço AISI 302
- 6 Conexão terminal em Latão
- 7 Soquete em Latão
- 8 Luva em Latão Niquelado
- 9 Obturador em Latão
- 10 Anel de retenção tipo Seeger em bronze/latão
- 11 Plug em latão
- 12 Molla otturatore in acciaio AISI 302
- 13 Obturador em latão
- 14 Anel de retenção tipo Seeger em aço AISI 302
- 15 Vedação O-Ring em FKM
- 16 Vedação

Pressioni e Temperature
IT

Pressioni e temperature sono determinate dal tipo di tubo impiegato, pertanto tali valori sono da definirsi in base alle caratteristiche del tubo stesso.

I valori riguardano quindi esclusivamente i componenti da noi prodotti.

Pressures and Temperatures
GB

The working pressures and working temperatures depend on which type of tube is used, for this reason, the values must be determined in accordance with the tube's features.

Therefore the values must be determined in accordance with the tube's features. The following values apply only to our products.

Druckbereich und Temperatur
DE

Drücke und Temperaturen sind definiert durch die verwendete Ausführung der Leitung, d.h. die Werte der eingesetzten Rohre sind zu beachten.

Die angegebenen Werte beziehen sich nur auf die Teile, die von uns produziert sind.

Pressions et Températures
FR

Les pressions et les températures sont à définir en accord avec les caractéristiques techniques des tubes utilisés.

Les valeurs mentionnées ci-dessus ne concernent que nos produits.

Presiones y Temperaturas
ES

Presión y temperatura vienen determinadas por el tipo de tubo utilizado, por lo tanto estos valores deben definirse en base a las características del mismo tubo.

Los valores por lo tanto solo se refieren a las componentes que nosotros producimos.

Pressões e Temperaturas
PT

Pressões e temperaturas são determinadas de acordo com o tipo de tubo empregado, portanto tais valores devem ser definidos com base nas características do tubo em questão.

Os valores mostrados a seguir se referem apenas aos componentes de nossos produtos.

Pressione d'esercizio
Working Pressures
Betriebsdruck
Pression de service
Presión de Ejercicio
Pressão de Trabalho
15 bar (1.5 MPa)

Temperature
Temperatures
Temperatur
Températures
Temperaturas
Temperaturas
- 15 °C
+ 200 °C

Fluidi compatibili
Acqua / Acqua refrigerata / Olio
Fluids
Water / Cooling water / Oil
Geeignete Medien
Wasser / Kühlwasser / Oel
Fluides compatibles
Eau / Eau de refroidissement / Huile
Fluidos compatibles
Agua / Agua refrigerada / Aceite
Fluidos compatíveis
Água / Água refrigerada / Óleo

Filettatura
IT

Gas cilindrica conforme ISO 228 Classe A.
Gas conica conforme ISO 7.1, BS 21, DIN 2999.

Threads
GB

Parallel gas in conformity with ISO 228 Class A.
Tapered gas in conformity with ISO 7.1, BS 21, DIN 2999.

Gewindearten
DE

Zylindrisches Gewinde nach Norm ISO 228 Classe A.
Konisches Gewinde nach Norm ISO 7.1, BS 21, DIN 2999.

Filetages
FR

Filetage cylindrique conforme: ISO 228 Class A.
Filetage conique conforme: ISO 7.1, BS 21, DIN 2999.

Roscas
ES

Gas cilíndrica conforme ISO 228 Clase A.
Gas cónica conforme ISO 7.1, BS 21, DIN 2999.

Roscas
PT

Gas paralela conforme ISO 228 Classe A.
Gas cónica conforme ISO 7.1, BS 21, DIN 2999.



La geometria di questi giunti segue il profilo internazionale largamente diffuso nel campo del raffreddamento dello stampo.
E' disponibile sia la versione otturata che quella non otturata.

IT

The profile of these quick couplings below the international profile of widespread cooling in the mold.
Is available not blocked and blocked version.

GB

Die Geometrie dieser Schnellkupplungen entspricht den international verbreiteten Profilen für Werkzeugkühlungen.
Erhältlich gibt es diese Verbindungen in gesperrter - oder nicht gesperrter Version.

DE

Ce profil correspond au profil international très répandu pour le refroidissement des moules.
Ils sont disponibles avec ou sans clapet.

FR

La geometría de estos enchufes sigue el perfil internacional mayormente generalizado en el campo del enfriamiento de moldes.
Está disponible la versión obturada y la no obturada.

ES

A geometria destas conexões segue o perfil internacional largamente difundido no campo do resfriamento de moldes de estampo.
Está disponível nas versões com e sem retenção.

PT

SERIE 430 INTERNATIONAL PROFILE DN6

431

PRESA CON ATTACCO MASCHIO CILINDRICO

MALE PARALLEL SOCKET
 VERSCHLUSS-KUPPLUNG MIT AUSSENGEWINDE ZYLINDRISCH
 COUPLEUR MÂLE
 ENCHUFE MACHO CILÍNDRICO
 SOQUETE COM ROSCA MACHO PARALELA

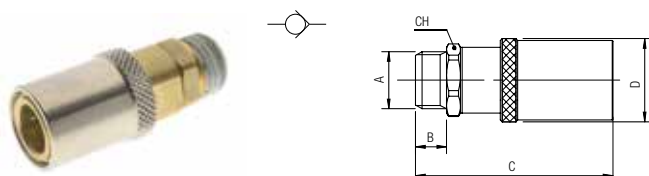

Code	A	B	C	D	CH	Pack.
00431 00 001	1/4	8	42.5	18.5	14	10

FILETTO PRE SIGILLATO
 PRE-COATING THREAD
 GEWINDE BESCHICHTET
 PRÉ-COATING
 ROSCA PRESELLADA
 ROSCA TEFLONADA

432

PRESA CON ATTACCO FEMMINA

FEMALE SOCKET
 VERSCHLUSS-KUPPLUNG MIT INNENGEWINDE
 COUPLEUR FEMELLE
 ENCHUFE HEMBRA
 SOQUETE COM ROSCA FÊMEA

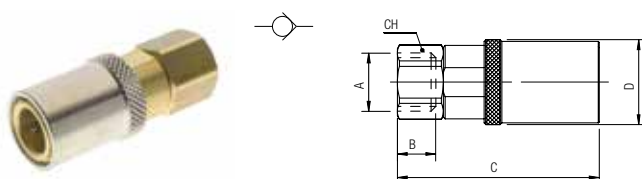

Code	A	B	C	D	CH	Pack.
00432 00 001	1/4	11	43.5	18.5	15	10

435

PRESA CON PORTAGOMMA DIRITTO

STRAIGHT SOCKET WITH REST FOR RUBBER HOSE
 VERSCHLUSS-KUPPLUNG MIT SCHLAUCHTÜLLE
 COUPLEUR À DOUILLE ANNELÉE
 ENCHUFE CON PORTAGOMA RECTO
 SOQUETE COM ESPIGÃO P/TUBO DE BORRACHA RETO

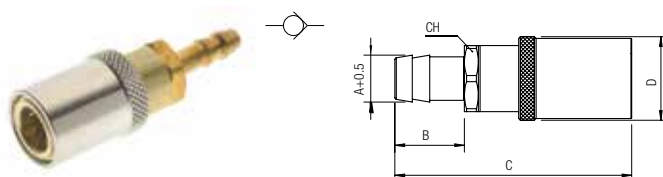

Code	A	B	C	D	CH	Pack.
00435 00 001	6	20	54.5	18.5	14	10
00435 00 002	9	20	54.5	18.5	14	10

436

PRESA CON PORTAGOMMA 90°

STRAIGHT SOCKET WITH 90° REST FOR RUBBER HOSE
 VERSCHLUSS-KUPPLUNG MIT SCHLAUCHTÜLLE 90°
 COUPLEUR À 90°, À DOUILLE ANNELÉ
 ENCHUFE CON PORTAGOMA 90°
 SOQUETE COM ESPIGÃO P/ TUBO DE BORRACHA A 90°

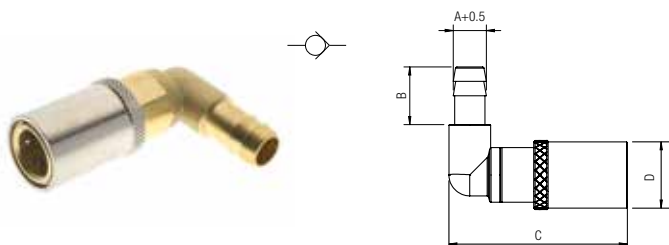

Code	A	B	C	D	Pack.
00436 00 001	6	17.5	41.5	18.5	10
00436 00 002	9	20	44	18.5	10

431SW

PRESA SENZA OTTURATORE CON ATTACCO MASCHIO CILINDRICO
 MALE PARALLEL SOCKET WITHOUT SHUTTER
 KUPPLUNG OHNE ABSPERRUNG MIT AUSSENGEWINDE ZYLINDRISCH
 COUPLEUR MALE CONIQUE SANS CLAPET
 ENCHUFE SIN OBTURADOR MACHO CILÍNDRICO
 SOQUETE COM ROSCA MACHO PARALELA TEFLONADA

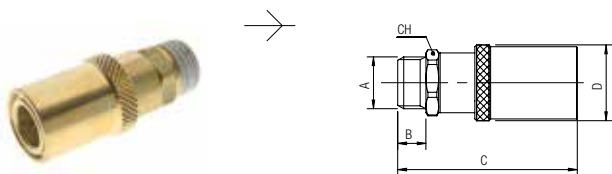

Code	A	B	C	D	CH	Pack.
431SW 00 001	1/4	8	42.5	18.5	14	10

FILETTO PRE SIGILLATO
 PRE-COATING THREAD
 GEWINDE BESCHICHTET
 PRÉ-COATING
 ROSCA PRESELLADA
 ROSCA TEFLONADA

432SW

PRESA SENZA OTTURATORE CON ATTACCO FEMMINA
 FEMALE SOCKET WITHOUT SHUTTER
 KUPPLUNG OHNE ABSPERRUNG MIT INNENGEWINDE
 COUPLEUR FEMELLE, SANS CLAPET
 ENCHUFE SIN OBTURADOR HEMBRA
 SOQUETE SEM OBTURADOR COM ROSCA FÊMEA

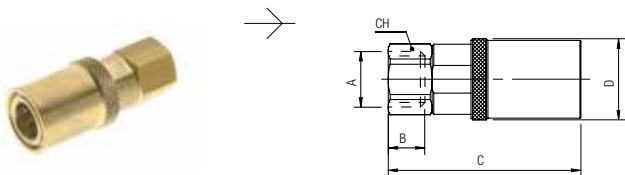

Code	A	B	C	D	CH	Pack.
432SW 00 001	1/4	11	43.5	18.5	14	10

435SW

PRESA SENZA OTTURATORE CON PORTAGOMMA
 STRAIGHT SOCKET WITH REST FOR RUBBER HOSE WITHOUT SHUTTER
 KUPPLUNG OHNE ABSPERRUNG MIT SCHLAUCHTÜLLE
 COUPLEUR À DOUILLE ANNELÉE, SANS CLAPET
 ENCHUFE SIN OBTURADOR CON PORTAGOMA
 SOQUETE COM ESPIGÃO PARA TUBO DE BORRACHA

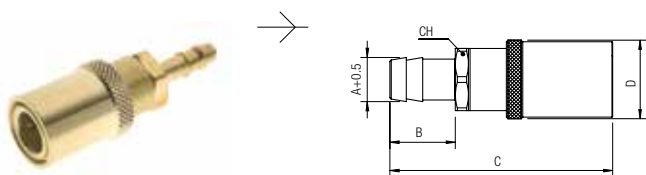

Code	A	B	C	D	CH	Pack.
435SW 00 001	6	20	54.5	18.5	14	10
435SW 00 002	9	20	54.5	18.5	14	10

436SW

PRESA SENZA OTTURATORE CON PORTAGOMMA 90°
 STRAIGHT SOCKET WITH 90° REST FOR RUBBER HOSE WITHOUT SHUTTER
 KUPPLUNG OHNE ABSPERRUNG MIT SCHLAUCHTÜLLE 90°
 COUPLEUR À 90°, À DOUILLE ANNELÉ, SANS CLAPET
 ENCHUFE SIN OBTURADOR CON PORTAGOMA 90°
 SOQUETE COM ESPIGÃO PARA TUBO DE BORRACHA A 90°

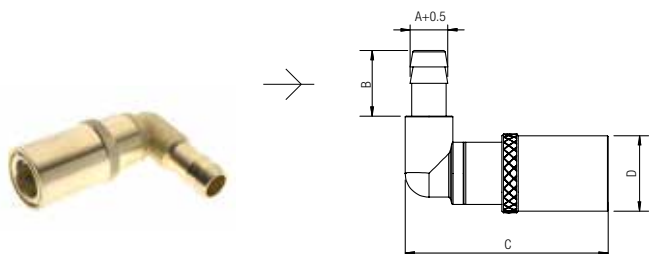

Code	A	B	C	D	Pack.
436SW 00 001	6	17.5	41.5	18.5	10
436SW 00 002	9	20	44	18.5	10

531

INNESTO CON ATTACCO MASCHIO CONICO

MALE PLUG (TAPER)

STECKER MIT AUSSENGEWINDE KONISCH

EMBOUT MALE CONIQUE SANS CLAPET

ADAPTADOR MACHO CÓNICO

PLUG COM ROSCA MACHO CÔNICA

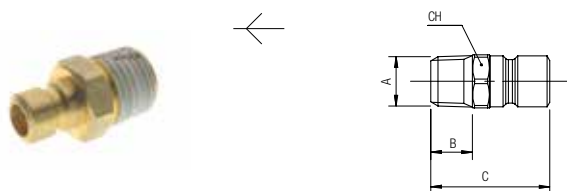

Code	A	B	C	CH	Pack.
00531 00 001	1/8	7.5	22	13	10
00531 00 002	1/4	11	26.5	14	10
00531 00 003	3/8	11.5	27	17	10

FILETTO PRE SIGILLATO
 PRE-COATING THREAD
 GEWINDE BESCHICHTET
 PRÉ-COATING
 ROSCA PRESELLADA
 ROSCA TEFLONADA

532

INNESTO CON ATTACCO FEMMINA

FEMALE PLUG

STECKER MIT INNENGEWINDE

EMBOUT FEMELLE

ADAPTADOR HEMBRA

PLUG COM ROSCA FÊMEA

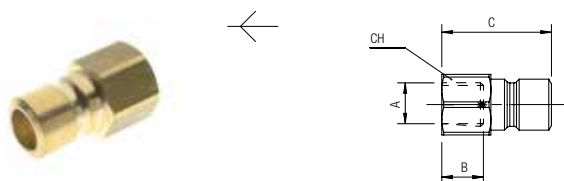

Code	A	B	C	CH	Pack.
00532 00 01 02 00	1/8	7.5	20	13	10
00532 00 01 03 00	1/4	11	23.5	16	10
00532 00 01 04 00	3/8	11.5	24	19	10

534

INNESTO OTTURATO CON ATTACCO MASCHIO CONICO

MALE SHUTTER PLUG (TAPER)

STECKER ABSPERREND MIT AUSSENGEWINDE KONISCH

EMBOUT MÂLE, AVEC OBTURATION

ADAPTADOR OBTURADO MACHO CÓNICO

PLUG COM RETENÇÃO E ROSCA MACHO CÔNICA

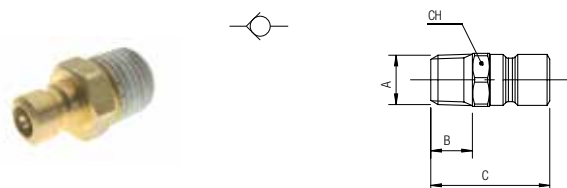

Code	A	B	C	CH	Pack.
00534 00 001	1/4	11	26.5	14	10
00534 00 002	3/8	11.5	27	17	10

Utilizzare solo con art. 431 - 432 - 435 - 436.

Use only with art. 431 - 432 - 435 - 436.

Verwenden sie nur mit art. 431 - 432 - 435 - 436.

Utiliser uniquement avec art. 431 - 432 - 435 - 436.

Utilizar solamente con art. 431 - 432 - 435 - 436.

Usar somente com art. 431 - 432 - 435 - 436.

FILETTO PRE SIGILLATO
 PRE-COATING THREAD
 GEWINDE BESCHICHTET
 PRÉ-COATING
 ROSCA PRESELLADA
 ROSCA TEFLONADA

535

INNESTO CON PORTAGOMMA

STRAIGHT PLUG WITH REST FOR RUBBER HOSE

STECKER MIT SCHLAUCHTÜLLE

EMBOUT À DOUILLE ANNELE

ADAPTADOR CON PORTAGOMA

PLUG COM ESPIGÃO PARA TUBO DE BORRACHA

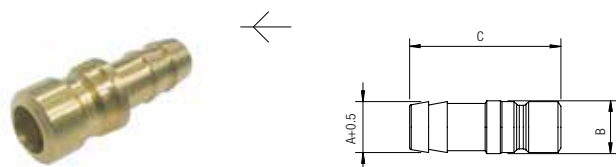

Code	A	B	C	Pack.
00535 00 01 X8 00	9	10	34.5	10

SERIE 440 INTERNATIONAL PROFILE DN9
441
PRESA CON ATTACCO MASCHIO CILINDRICO

MALE PARALLEL SOCKET

VERSCHLUSS-KUPPLUNG MIT AUSSENGEWINDE ZYLINDRISCH

COUPLEUR MÂLE

ENCHUFE MACHO CILÍNDRICO

SOQUETE COM ROSCA MACHO PARALELA

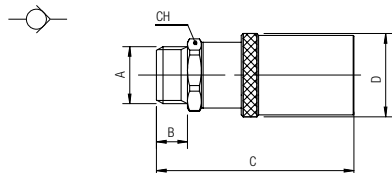

Code	A	B	C	D	CH	Pack.
00441 00 001	3/8	9	57	24	19	10

FILETTO PRE SIGILLATO
 PRE-COATING THREAD
 GEWINDE BESCHICHTET
 PRÉ-COATING
 ROSCA PRESELLADA
 ROSCA TEFLONADA

442
PRESA CON ATTACCO FEMMINA

FEMALE SOCKET

VERSCHLUSS-KUPPLUNG MIT INNENGEWINDE

COUPLEUR FEMELLE

ENCHUFE HEMBRA

SOQUETE COM ROSCA FÊMEA

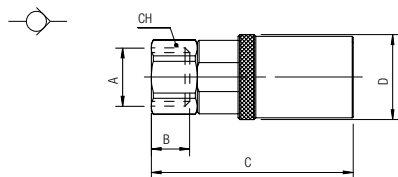

Code	A	B	C	D	CH	Pack.
00442 00 001	1/4	11	57	24	19	10

445
PRESA CON PORTAGOMMA DIRITTO

STRAIGHT SOCKET WITH REST FOR RUBBER HOSE

VERSCHLUSS-KUPPLUNG MIT SCHLAUCHTÜLLE

COUPLEUR À DOUILLE ANNELÉE

ENCHUFE CON PORTAGOMA RECTO

SOQUETE COM ESPIGÃO P/TUBO DE BORRACHA RETO

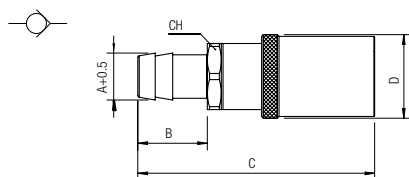

Code	A	B	C	D	CH	Pack.
00445 00 001	11	20	68	24	19	10
00445 00 002	13	20	68	24	19	10

446
PRESA CON PORTAGOMMA 90°

STRAIGHT SOCKET WITH 90° REST FOR RUBBER HOSE

VERSCHLUSS-KUPPLUNG MIT SCHLAUCHTÜLLE 90°

COUPLEUR À 90°, À DOUILLE ANNELÉ

ENCHUFE CON PORTAGOMA 90°

SOQUETE COM ESPIGÃO P/TUBO DE BORRACHA A 90°

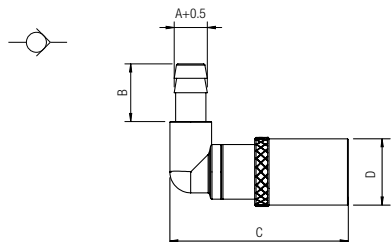

Code	A	B	C	D	Pack.
00446 00 001	11	20	62	24	10
00446 00 002	13	20	62	24	10

441SW

PRESA SENZA OTTURATORE CON ATTACCO MASCHIO CILINDRICO
 MALE PARALLEL SOCKET WITHOUT SHUTTER
 KUPPLUNG OHNE ABSPERRUNG MIT AUSSENGEWINDE ZYLINDRISCH
 COUPLEUR MALE CONIQUE SANS CLAPET
 ENCHUFE SIN OBTURADOR MACHO CILÍNDRICO
 SOQUETE COM ROSCA MACHO PARALELA

Code	A	B	C	D	CH	Pack.
441SW 00 001	3/8	9	57	24	19	10

FILETTO PRE SIGILLATO
 PRE-COATING THREAD
 GEWINDE BESCHICHTET
 PRÉ-COATING
 ROSCA PRESELLADA
 ROSCA TEFLONADA

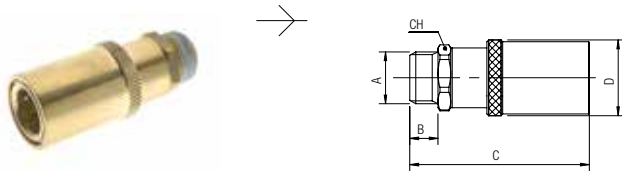

442SW

PRESA SENZA OTTURATORE CON ATTACCO FEMMINA
 FEMALE SOCKET WITHOUT SHUTTER
 KUPPLUNG OHNE ABSPERRUNG MIT INNENGEWINDE
 COUPLEUR FEMELLE, SANS CLAPET
 ENCHUFE SIN OBTURADOR HEMBRA
 SOQUETE SEM OBTURADOR COM ROSCA FÊMEA

Code	A	B	C	D	CH	Pack.
442SW 00 001	1/4	11	57	24	19	10

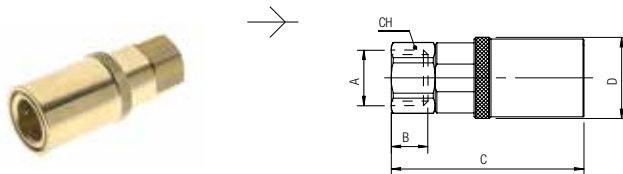

445SW

PRESA SENZA OTTURATORE CON PORTAGOMMA
 STRAIGHT SOCKET WITH REST FOR RUBBER HOSE WITHOUT SHUTTER
 KUPPLUNG OHNE ABSPERRUNG MIT SCHLAUCHTÜLLE
 COUPLEUR À DOUILLE ANNELÉE, SANS CLAPET
 ENCHUFE SIN OBTURADOR CON PORTAGOMA
 SOQUETE COM ESPIGÃO PARA TUBO DE BORRACHA

Code	A	B	C	D	CH	Pack.
445SW 00 001	11	20	68	24	19	10
445SW 00 002	13	20	68	24	19	10

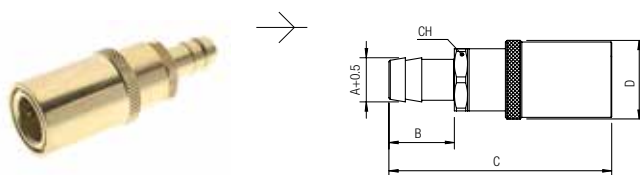

446SW

PRESA SENZA OTTURATORE CON PORTAGOMMA 90°
 STRAIGHT SOCKET WITH 90° REST FOR RUBBER HOSE WITHOUT SHUTTER
 KUPPLUNG OHNE ABSPERRUNG MIT SCHLAUCHTÜLLE 90°
 COUPLEUR À 90°, À DOUILLE ANNELÉ, SANS CLAPET
 ENCHUFE SIN OBTURADOR CON PORTAGOMA 90°
 SOQUETE COM ESPIGÃO PARA TUBO DE BORRACHA A 90°

Code	A	B	C	D	Pack.
446SW 00 001	11	20	62	24	10
446SW 00 002	13	20	62	24	10

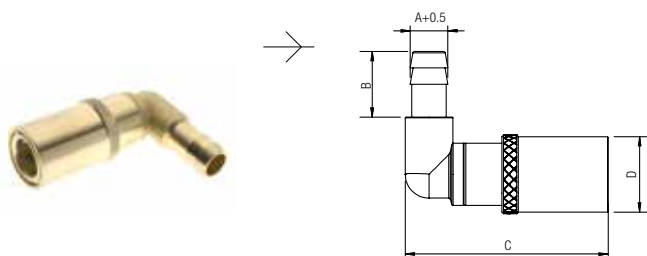

541

INNESTO CON ATTACCO MASCHIO CONICO

MALE PLUG (TAPER)
 STECKER MIT AUSSENGEWINDE KONISCH
 EMBOUT MALE CONIQUE SANS CLAPET
 ADAPTADOR MACHO CÓNICO
 PLUG COM ROSCA MACHO CÔNICA

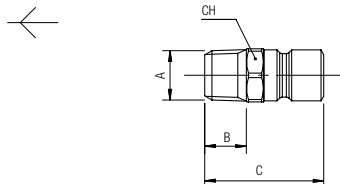

Code	A	B	C	CH	Pack.
00541 00 001	1/4	11	31.5	16	10
00541 00 002	3/8	11.5	32.5	17	10
00541 00 003	1/2	14	36.5	22	10

FILETTO PRE SIGILLATO
 PRE-COATING THREAD
 GEWINDE BESCHICHTET
 PRÉ-COATING
 ROSCA PRESELLADA
 ROSCA TEFLONADA

542

INNESTO CON ATTACCO FEMMINA

FEMALE PLUG
 STECKER MIT INNENGEWINDE
 EMBOUT FEMELLE
 ADAPTADOR HEMBRA
 PLUG COM ROSCA FÊMEA

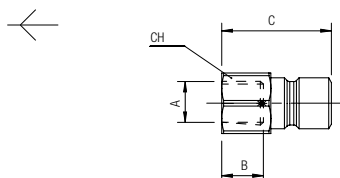

Code	A	B	C	CH	Pack.
00542 00 01 03 00	1/4	11	29	16	10
00542 00 01 04 00	3/8	11.5	29.5	19	10
00542 00 01 05 00	1/2	15	33	24	10

544

INNESTO OTTURATO CON ATTACCO MASCHIO CONICO

MALE SHUTTER PLUG (TAPER)
 STECKER ABSPERREND MIT AUSSENGEWINDE KONISCH
 EMBOUT MÂLE, AVEC OBTURATION
 ADAPTADOR OBTURADO MACHO CÓNICO
 PLUG COM RETENÇÃO E ROSCA MACHO CÔNICA

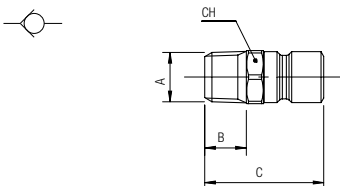

Code	A	B	C	CH	Pack.
00544 00 001	3/8	11.5	32.5	17	10
00544 00 002	1/2	14	36.5	22	10

Utilizzare solo con art. 441 - 442 - 445 - 446.
 Use only with art. 441 - 442 - 445 - 446.
 Verwenden sie nur mit art. 441 - 442 - 445 - 446.
 Utiliser uniquement avec art. 441 - 442 - 445 - 446.
 Utilizar solamente con art. 441 - 442 - 445 - 446.
 Usar somente com art. 441 - 442 - 445 - 446.

FILETTO PRE SIGILLATO
 PRE-COATING THREAD
 GEWINDE BESCHICHTET
 PRÉ-COATING
 ROSCA PRESELLADA
 ROSCA TEFLONADA

545

INNESTO CON PORTAGOMMA

STRAIGHT PLUG WITH REST FOR RUBBER HOSE
 STECKER MIT SCHLAUCHTÜLLE
 EMBOUT À DOUILLE ANNELÉ
 ADAPTADOR CON PORTAGOMA
 PLUG COM ESPIGÃO PARA TUBO DE BORRACHA

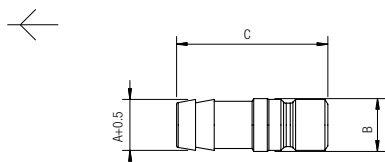

Code	A	B	C	Pack.
00545 00 01 Y2 00	13	14	40	10

