

GIUNTI AD INNESTO RAPIDO E PISTOLE AD ARIA

AUTOMATIC QUICK COUPLINGS AND BLOW GUNS

SCHNELLVERSCHLUSS-KUPPLUNGEN UND BLASPISTOLEN

COUPLEURS AUTOMATIQUES ET SOUFFLETES

ENCHUFES RÁPIDOS Y PISTOLAS DE AIRE

CONEXÕES DE ENGATE RÁPIDO E PISTOLAS DE AR



Serie Quick Couplings

Prese ad Innesto Rapido - Quick Couplings - Schnellverschluss Kupplungen
 Coupleurs Automatiques - Enchufes Rápidos - Conexões de Engate Rápido



Prese di Sicurezza ad Innesto Rapido - Safety Quick Couplings - Kupplungen Sicherheit - Coupleurs de Sécurité
 Enchufes de Seguridad - Conexões de Segurança









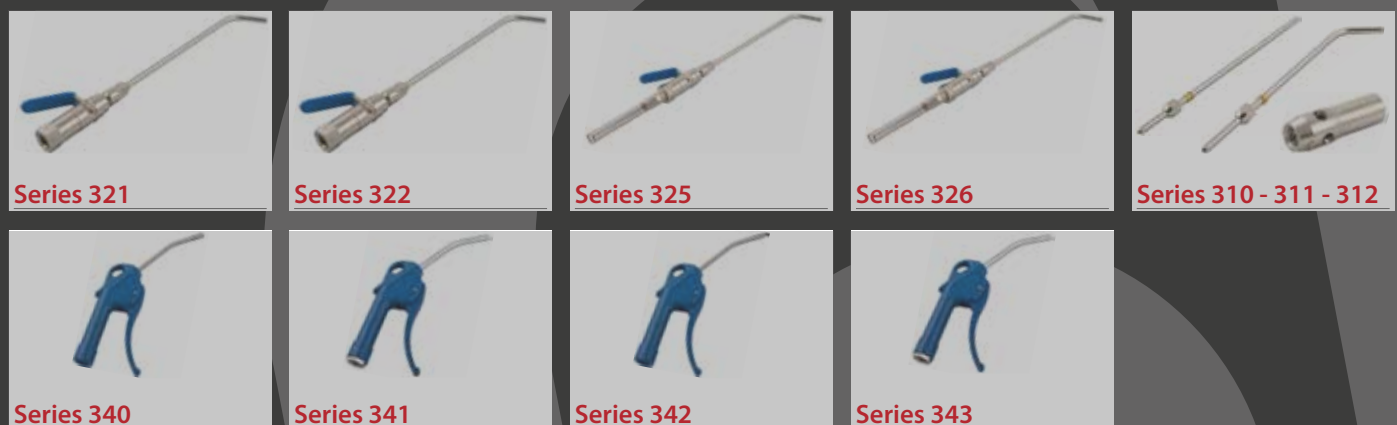

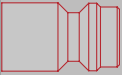

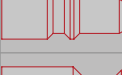

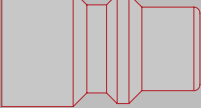
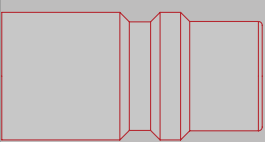
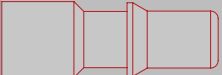
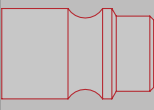
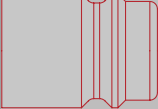
Giunti ad Innesto Rapido per Raffreddamento Stampi - Quick Couplings for Molding Cooling - Schnellkupplungen Für Spritzgussanwendungen
 Coupleurs pour Moulés D'injection - Enchufes Rápidos para Refrigeración de Moldes - Conexões de Engate Rápido para Resfriamento de Moldes

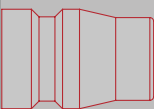
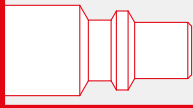

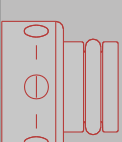
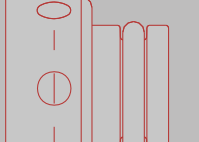
Pistole di Soffiaggio - Blow Guns - Blaspistolen - Soufflettes - Pistolas Sopladoras - Pistola de Ar

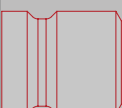

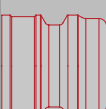
PLUG PROFILE 1:1	STANDARD	SERIE PLUG	STANDARD COUPLINGS	MULTI COUPLINGS	SERIE SAFETY	SERIE INOX
	DN 5	MIGNON	210	110		
	DN 5	MIGNON DOUBLE SHUT OFF	280	180		
	DN 2.5	UNI-ISO 6150-A6	200	100		
	DN 5.5	UNI-ISO 6150-B12 INDUSTRIAL 1/4	220	120	190	620
	DN 9	UNI-ISO 6150-B15 INDUSTRIAL 3/8	230	130	720	
	DN 12	UNI-ISO 6150-B17 INDUSTRIAL 1/2	810	710		
	DN 5.5	UNI-ISO 6150-C10	240	140		
	DN 7.5 - 7.8	EUROPEAN	260 63260	160	190	660 63190
	DN 10	EUROPEAN DN 10	820	720		
	DN 5.5	SWISS	270	170	190	670
	DN 7.5	JAPANESE	500 Pag. 15.61	400		
	DN 5	ITALIAN	250	120	190	650
	DN 2.7	MINI	800	700		
	DN 8	FRENCH	510	410		
	DN 12	FRENCH	520	420		
	DN 6	INTERNATIONAL	530	430		
	DN 9	INTERNATIONAL	540	440		
	DN 6	EUROPEAN	560	460		
	DN 9	EUROPEAN	570	470		

ARIA - AIR - LUFT - AIR - AIRE - AR

ACQUA - WATER - WASSER - EAU - AGUA - ÁGUA
 OLIO - OIL - ÖL - HUILE - ACEITE - ÓLEO

INTERCAMBIABILITÀ - INTERCHANGE - AUSTAUSCHBARKEIT - INTERCHANGEABILITÉ - INTERCAMBIABILIDAD - INTERCAMBIABILIDADE

RECTUS/LEGRIS PARKER 21/90	CAMOZZI 5050 - 5150	CEJN 220		FESTO KD - KS 3	
RECTUS/PARKER 21/90	CAMOZZI 5050 - 5150	CEJN 200			
				FESTO KD - KS 2	
RECTUS/LEGRIS 23/24 PARKER 20/30 - 1/4 TEMA 1400	HANSEN 3000	CEJN 310	INDUSTRIAL 1/4	GROMELLE 600	US - MIL SPEC C-4109
RECTUS/LEGRIS 30 PARKER 30 - 3/8	HANSEN 4000	CEJN 430	INDUSTRIAL 3/8	GROMELLE 900	US - MIL SPEC C-4109
RECTUS 37	HANSEN 5000	CEJN 550		GROMELLE 1300	US - MIL SPEC C-4109
RECTUS/LEGRIS 18					
RECTUS/LEGRIS 25/26/1600/1625 TEMA 1600	CAMOZZI 5080 - 5180	CEJN 320		FESTO KD - KS 6 KD - KS 4	
RECTUS/LEGRIS 27		CEJN 410			
RECTUS/LEGRIS 14/22 PARKER 50	HANSEN 210	CEJN 300		ARO 210	
RECTUS/LEGRIS 13	SMC KK130	CEJN 315	NITTO KOHKI 200		
RECTUS/LEGRIS PARKER 20/91				FESTO KD - KS 2	
RECTUS 608					
RECTUS 612					
RECTUS 86	DME 1/4				
RECTUS 87	DME 3/8				
RECTUS 10	HASCO Z80/811HT/9 [Øe 9]	CEJN 220 - 221 - 225			
RECTUS 11	HASCO Z80/811HT/13 [Øe 13.5]				

SERIE 120 ITALIAN PROFILE



CARATTERISTICHE TECNICHE
 TECHNICAL CHARACTERISTICS
 TECHNISCHE ANGABEN
 CARACTÉRISTIQUES TECHNIQUES
 CARACTERÍSTICAS TÉCNICAS
 CARACTERÍSTICAS TÉCNICAS



Norma di Riferimento
 Reference standard
 Entspricht der Norm
 Norme de référence
 Normativa de referencia
 Norma de referència

1907/2006 REACH ✓	2011/65/CE RoHS ✓
PED 2014/68/UE	SILICON FREE

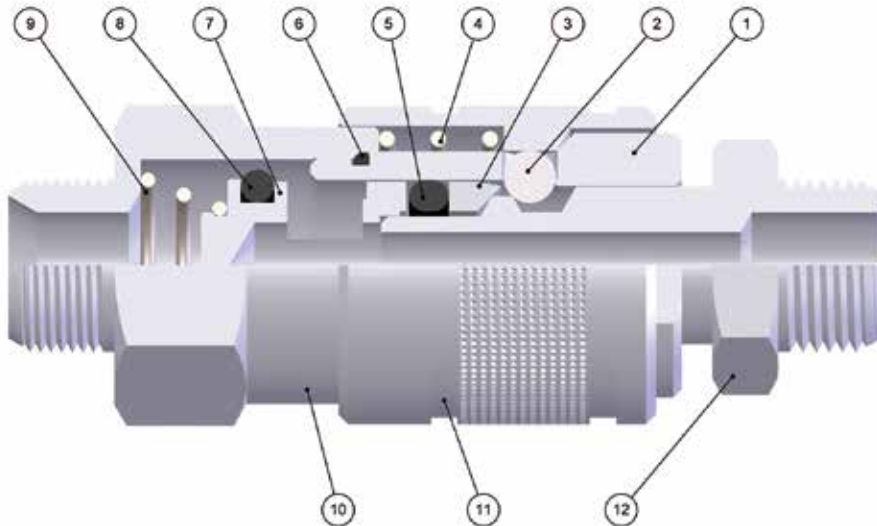

FKM A RICHIESTA
 IF REQUESTED FKM
 FKM AUF ANFRAGE
 FKM SUR DEMANDE
 FKM BAJO DEMANDA
 FKM SOB ENCOMENDA

DN
5 mm

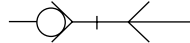

ITALIAN

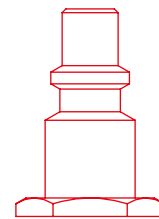

1:1

Materiali e Componenti	IT	Component Parts and Materials	GB	Komponenten und Materialien	DE
1 Corpo in Ottone Nichelato		1 Nickel-Plated Brass Body		1 Körper Messing Vernickelt	
2 Sfera in Acciaio AISI 420		2 Stainless Steel AISI 420 Balls		2 Kugel Edelstahl AISI 420	
3 Anello Guida Innesto in Ottone Nichelato		3 Nickel-Plated Brass Guide Ring Coupling		3 Stecker Führungsring Messing Vernickelt	
4 Molla Ghiera in Acciaio AISI 302		4 Stainless Steel AISI 302 Ring Nut Spring		4 Entriegelungsfeder Edelstahl AISI 302	
5 Guarnizione O-Ring in NBR		5 NBR O-Ring Seals		5 O-Ring NBR	
6 Guarnizione O-Ring in NBR		6 NBR O-Ring Seals		6 O-Ring NBR	
7 Otturatore in Ottone Nichelato		7 Nickel-Plated Brass Shutter		7 Verschluss Messing Vernickelt	
8 Guarnizione O-Ring in NBR		8 NBR O-Ring Seals		8 O-Ring NBR	
9 Molla Otturatore in Acciaio AISI 302		9 Stainless Steel AISI 302 Shutter Spring		9 Verschlussfeder Edelstahl AISI 302	
10 Attacco Terminale in Ottone Nichelato		10 Nickel-Plated Brass Coupling Back Part		10 Einschraubkörper Messing Vernickelt	
11 Ghiera in Ottone Nichelato		11 Nickel-Plated Brass Sleeve		11 Entriegelungshülse Messing Vernickelt	
12 Innesto in Ottone Nichelato		12 Nickel-Plated Brass Plug Outline		12 Stecker Messing Vernickelt	

Matériaux et Composants	FR	Materiales y Componentes	ES	Materials e Componentes	PT
1 Corps: Laiton Nickelé		1 Cuerpo en latón niquelado		1 Corpo em Latão Niquelado	
2 Bille: Acier Inoxydable AISI 420		2 Esfera en acero AISI 420		2 Esfera em aço AISI 420	
3 Bague de Guidage: Laiton Nickelé		3 Anillo guía enchufe en latón niquelado		3 Anel guia do plug em latão niquelado	
4 Ressort de Bague: Acier Inoxydable AISI 302		4 Muelle tuerca en acero AISI 302		4 Mola da porca em aço AISI 302	
5 Joint Torique en NBR		5 Junta tórica en NBR		5 Vedação O-Ring em NBR	
6 Joint Torique en NBR		6 Junta tórica en NBR		6 Vedação O-Ring em NBR	
7 Clapet: Laiton Nickelé		7 Obturador en latón niquelado		7 Obturador em latão niquelado	
8 Joint Torique en NBR		8 Junta tórica en NBR		8 Vedação O-Ring em NBR	
9 Ressort de Clapet: Acier Inoxydable AISI 302		9 Muelle obturador en acero AISI 302 9		9 Mola do obturador em aço AISI 302	
10 Corps: Laiton Nickelé		10 Terminal de conexión en latón niquelado		10 Conexão terminal em latão niquelado	
11 Bague: Laiton Nickelé		11 Tuerca en latón niquelado		11 Porca em latão niquelado	
12 Embout: Laiton Nickelé		12 Enchufe en latón niquelado		12 Plug em latão niquelado	



Pressione d'esercizio

Working Pressures

Betriebsdruck

Pression de service

Presión de Ejercicio

Pressão de Trabalho

0 bar

16 bar



Max pressione statica (no pulsazioni)

Maximum static pressure (no pulsations)

Maximaler statischer Betriebsdruck (ohne pulsations)

Pression statique maximale (sans pulsation)

Presión estática máxima (sin pulsaciones)

Pressão estática máxima (sem pulsações)

35 bar



Temperature

Temperatures

Temperatur

Températures

Temperaturas

Temperaturas

- 20 °C

+ 80 °C

Con O-ring in FKM

With FKM O-ring

Mit O-ring in FKM

Avec joints en FKM

Con junta tórica en FKM

Com O-ring em FKM

- 10 °C

+ 200 °C



Fluidi compatibili

Aria compressa

Fluids

Compressed air

Geeignete Medien

Druckluft

Fluides compatibles

Air comprimé

Fluidos compatibles

Aire comprimido

Fluidos compatíveis

Ar comprimido

Per altri fluidi, consultare l'ufficio tecnico Aignep.

For other fluids, consult the technical department Aignep.

Für andere Flüssigkeiten, kontaktieren Sie uns.

Pour d'autres fluides, veuillez nous consulter.

Para otros fluidos póngase en contacto con el departamento técnico Aignep.

Para outros fluidos consulte o departamento técnico da Aignep.



Portata

NI/min

Flow Rate

Durchflusswerte

Débit

Caudal de Flujo

Vazão

6 bar

Δ 1

1100

6 bar

Δ 0.5

800

6 bar

Δ 0*

1500

* Scarico libero - Exhaust Free - Kostenlose Auspuff - Échappement libre - Escape Libre - Descarga livre.



Filettatura

IT

Gas cilindrica conforme ISO 228 Classe A.

Threads

GB

Parallel gas in conformity with ISO 228 Class A.

Gewindearten

DE

Zylindrisches Gewinde nach Norm ISO 228 Classe A.

Filetages

FR

Filetage cylindrique conforme: ISO 228 Class A.

Roscas

ES

Gas cilíndrica conforme ISO 228 Clase A.

Roscas

PT

Gas paralela conforme ISO 228 Classe A.

121

PRESA CON ATTACCO MASCHIO

MALE SOCKET
 MIT AUSSENGEWINDE
 COUPLEUR MÂLE
 ENCHUFE MACHO
 SOQUETE COM ROSCA MACHO

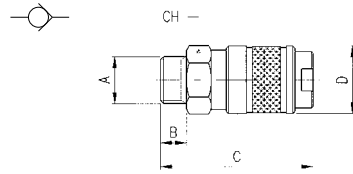

Code	A	B	C	D	CH	Pack.
00121 00 001	1/4	8	53	24	21	10
00121 00 002	3/8	9	54	24	21	10
00121 00 003	1/2	10	55	24	24	10

122

PRESA CON ATTACCO FEMMINA

FEMALE SOCKET
 VERSCHLUSS-KUPPLUNG MIT INNENGEWINDE
 COUPLEUR FEMELLE
 ENCHUFE HEMBRA
 SOQUETE COM ROSCA FÊMEA

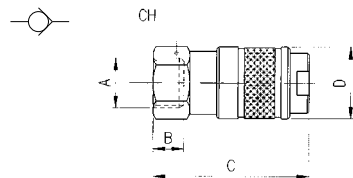

Code	A	B	C	D	CH	Pack.
00122 00 001	1/4	11	55	24	21	10
00122 00 002	3/8	11.5	55.5	24	21	10
00122 00 003	1/2	14	59	24	24	10

123

PRESA CON ATTACCO A CALZAMENTO CON MOLLA

COMPRESSION SOCKET WITH SPRING
 VERSCHLUSS-KUPPLUNG MIT KNICKSCHUTZFEDER
 COUPLEUR AVEC RESSORT DE PROTECTION
 ENCHUFE TUBO COM MUELLE
 SOQUETE COM CONEXÃO PUSH-ON COM MOLA

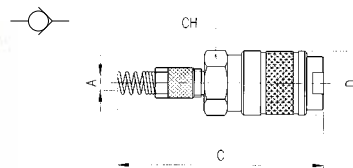

Code	A	B	C	D	CH	Pack.
00123 00 001	6/4	-	141	24	21	10
00123 00 002	8/6	-	146.5	24	21	10
00123 00 003	10/8	-	154	24	21	10

124

PRESA CON ATTACCO A CALZAMENTO

COMPRESSION SOCKET
 VERSCHLUSS-KUPPLUNG MIT ÜBERWURFVERSCHRAUBUNG
 COUPLEUR RACCORD À COIFFE
 ENCHUFE TUBO
 SOQUETE COM CONEXÃO PUSH-ON

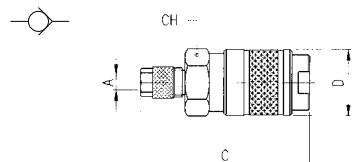

Code	A	B	C	D	CH	Pack.
00124 00 001	6/4	-	59	24	21	10
00124 00 002	8/6	-	59	24	21	10
00124 00 003	10/8	-	60	24	21	10

125

PRESA CON PORTAGOMMA A RESCA

SOCKET WITH REST FOR RUBBER HOSE

VERSCHLUSS-KUPPLUNG MIT SCHLAUCHTÜLLE

COUPLEUR À DOUILLE ANNELÉE POUR TUBE

ENCHUFE ESPIGA

SOQUETE COM ESPIGÃO PARA MANGUEIRA DE BORRACHA

Code	A	B	C	D	CH	Pack.
00125 00 001	6	-	64	24	21	10
00125 00 002	8	-	64	24	21	10
00125 00 003	10	-	64	24	21	10
00125 00 004	12	-	64	24	21	10

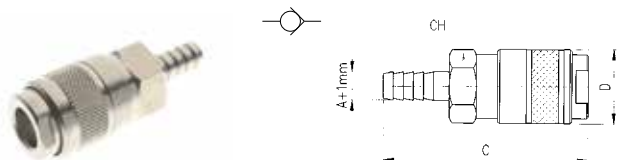

126

PRESA CON PORTAGOMMA

SOCKET FOR RUBBER HOSE

VERSCHLUSS-KUPPLUNG FÜR GUMMISCHLAUCH

COUPLEUR A DOUILLE POUR TUBE

ENCHUFE CON PORTAGOMA

SOQUETE COM ESPIGÃO PARA TUBO DE BORRACHA

Code	A	B	C	D	CH	Pack.
00126 00 001	14/6	-	72	24	21	10
00126 00 002	17/8	-	72	24	21	10
00126 00 003	19/10	-	72	24	21	10

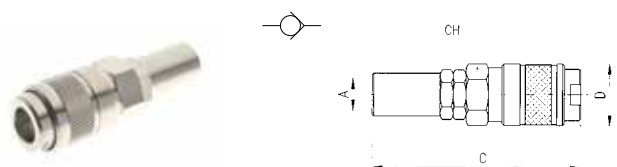

251

INNESTO CON ATTACCO MASCHIO

MALE PLUG

STECKER MIT AUSSENGEWINDE

EMBOUT MÂLE

ADAPTADOR MACHO

PLUG COM ROSCA MACHO

Code	A	B	C	D	CH	Pack.
00251 00 01 03 NB	1/4	8	38	-	17	10
00251 00 01 04 NB	3/8	9	39	-	19	10
00251 00 01 05 NB	1/2	10	40.5	-	24	10

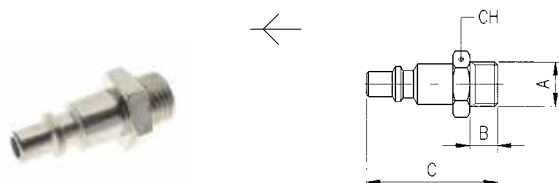

251AC

INNESTO IN ACCIAIO CON ATTACCO MASCHIO

STEEL MALE PLUG

STECKER MIT AUSSENGEWINDE AUS STAHL

EMBOUT MÂLE EN ACIER

ADAPTADOR EN ACERO MACHO

PLUG EM AÇO COM ROSCA MACHO

Code	A	B	C	D	CH	Pack.
251AC 00 51 03 ZI	1/4	8	38	-	17	10
251AC 00 51 04 ZI	3/8	9	39	-	19	10
251AC 00 51 05 ZI	1/2	10	40.5	-	24	10

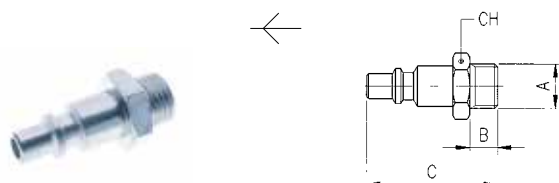

ACCIAIO INDURITO
HARDENED STEEL
GEHÄRTETEM STAHL
ACIER TREMPÉ
ACERO CURTIDO
AÇO ENDURECIDO

252

INNESTO CON ATTACCO FEMMINA

FEMALE PLUG
 STECKER MIT INNENGEWINDE
 EMBOUT FEMELLE
 ADAPTADOR HEMBRA
 PLUG COM ROSCA FÊMEA

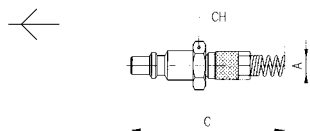

Code	A	B	C	D	CH	Pack.
00252 00 01 03 NB	1/4	11	38	-	17	10
00252 00 01 04 NB	3/8	11.5	38.5	-	19	10
00252 00 01 05 NB	1/2	14	41	-	24	10

252AC

INNESTO IN ACCIAIO CON ATTACCO FEMMINA

STEEL FEMALE PLUG
 STECKER MIT INNENGEWINDE AUS STAHL
 EMBOUT FEMELLE EN ACIER
 ADAPTADOR EN ACERO HEMBRA
 PLUG EM AÇO COM ROSCA FÊMEA

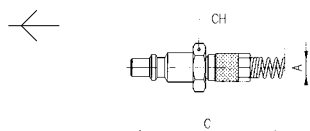

Code	A	B	C	D	CH	Pack.
252AC 00 51 03 ZI	1/4	11	38	-	17	10
252AC 00 51 04 ZI	3/8	11.5	38.5	-	19	10
252AC 00 51 05 ZI	1/2	14	41	-	24	10

ACCIAIO INDURITO
 HARDENED STEEL
 GEHÄRTETEM STAHL
 ACIER TREMPÉ
 ACERO CURTIDO
 AÇO ENDURECIDO

253

INNESTO CON ATTACCO A CALZAMENTO CON MOLLA

COMPRESSION PLUG WITH SPRING
 STECKER MIT KNICKSCHUTZFEDER
 EMBOUT AVEC RESSORT DE PROTECTION
 ADAPTADOR TUBO CON MUELLE
 PLUG COM CONEXÃO PUSH-ON COM MOLA

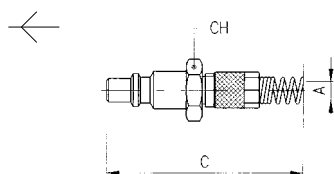

Code	A	B	C	D	CH	Pack.
00253 00 001	6/4	-	124.5	-	13	10
00253 00 002	8/6	-	130	-	13	10
00253 00 003	10/8	-	137.5	-	14	10
00253 00 004	12/10	-	143	-	16	10

254

INNESTO CON ATTACCO A CALZAMENTO

COMPRESSION PLUG
 STECKER MIT ÜBERWURFVERSCHRÄUBUNG
 EMBOUT À RACCORD À COIFFE
 ADAPTADOR TUBO
 PLUG COM CONEXÃO PUSH-ON

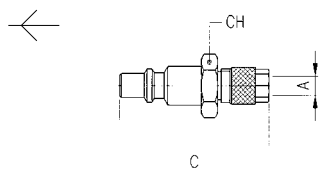

Code	A	B	C	D	CH	Pack.
00254 00 001	6/4	-	43.5	-	13	10
00254 00 002	8/6	-	43.5	-	13	10
00254 00 003	10/8	-	44.5	-	14	10
00254 00 004	12/10	-	46	-	16	10

255

INNESTO CON PORTAGOMMA A RESCA

PLUG WITH REST FOR RUBBER HOSE
 STECKER MIT SCHLAUCHTÜLLE
 EMBOUT À DOUILLE ANNELÉE POUR TUBE
 ADAPTADOR ESPIGA
 PLUG COM ESPIGÃO PARA TUBO DE BORRACHA



Code	A	B	C	D	CH	Pack.
00255 00 01 X4 NB	6	-	44.5	12	-	10
00255 00 01 X7 NB	8	-	44.5	12	-	10
00255 00 01 X9 NB	10	-	47.5	14	-	10
00255 00 01 Y1 NB	12	-	47.5	16	-	10

255AC

INNESTO IN ACCIAIO CON PORTAGOMMA A RESCA

STEEL PLUG WITH REST FOR RUBBER HOSE
 STECKER MIT SCHLAUCHTÜLLE AUS STAHL
 EMBOUT À DOUILLE ANNELÉE POUR TUBE EN ACIER
 ADAPTADOR EN ACERO ESPIGA
 PLUG EM AÇOÙ COM ESPIGÃO PARA TUBO DE BORRACHA



Code	A	B	C	D	CH	Pack.
255AC 00 51 X4 ZI	6	-	44.5	12	-	10
255AC 00 51 X7 ZI	8	-	44.5	12	-	10
255AC 00 51 X9 ZI	10	-	47.5	14	-	10
255AC 00 51 Y1 ZI	12	-	47.5	16	-	10

ACCIAIO INDURITO
 HARDENED STEEL
 GEHÄRTETEM STAHL
 ACIER TREMPÉ
 ACERO CURTIDO
 AÇO ENDURECIDO

256

INNESTO CON PORTAGOMMA

PLUG FOR RUBBER HOSE
 STECKER FÜR GUMMISCHLAUCH
 EMBOUT POUR TUBE
 ADAPTADOR CON PORTAGOMA
 PLUG COM ESPIGÃO PARA TUBO DE BORRACHA

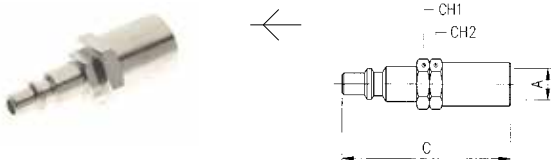

Code	A	B	C	CH1	CH2	Pack.
00256 00 001	14/6	-	60	15	17	10
00256 00 002	17/8	-	60	15	20	10
00256 00 003	19/10	-	60	15	22	10

257

INNESTO CON ATTACCO A BAIONETTA

BAYONET PLUG
 STECKER MIT BAJONETT-VERSCHLUSS
 EMBOUT À RACCORD À BAIONNETTE
 ADAPTADOR BAYONETA
 PLUG COM CONEXÃO TIPO BAIONETA

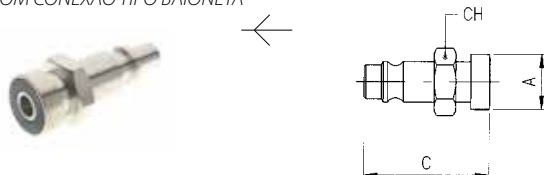

Code	A	B	C	D	CH	Pack.
00257 00 001	15	-	38.5	-	15	10

258

INNESTO A SCARICO PROGRESSIVO

PLUG WITH GRADUAL EXHAUST
 STECKER MIT PROGRESSIVER ENTLASTUNG
 EMBOUT À PASSAGE PROGRESSIF
 ADAPTADOR DE DESCARGA PROGRESIVA
 PLUG COM ESCAPE PROGRESSIVO

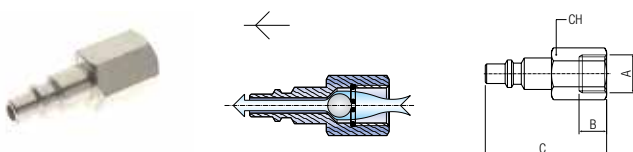

Code	A	B	C	CH	Pack.
00258 00 001	1/4	11	46.5	17	10

