



## **DISTRIBUTORI OLEODINAMICI DIRECTIONAL CONTROL VALVES**



CATALOGO TECNICO - *TECHNICAL CATALOGUE*



1ª edizione - \$\$\$

1<sup>st</sup> edition - \$\$\$

---

Il catalogo mostra il prodotto nelle configurazioni più comuni.  
Per informazioni più dettagliate o richieste particolari, contattare il nostro Servizio Commerciale.

**ATTENZIONE!**

Specifiche tecniche, disegni e descrizioni riportati nel presente catalogo, sono riferiti al prodotto standard al momento dell'entrata in stampa.

Walvoil, orientata al continuo miglioramento del prodotto, si riserva il diritto di apportare modifiche in ogni momento e senza obbligo di preavviso.

**WALVOIL NON RISPONDE DEI DANNI CHE DOVREBBERO ESSERE ARRECATI A PERSONE O COSE DERIVANTI DA UN USO IMPROPRIO DEL PRODOTTO.**

*This catalogue shows the product in the most standard configurations.  
Please contact our Sales Dpt. for more detailed information or special requests.*

**WARNING!**

*All specifications of this catalogue refer to the standard product at this date.  
Walvoil, oriented to a continuous improvement, reserves the right to discontinue, modify or revise the specifications, without notice.*

**WALVOIL IS NOT RESPONSIBLE FOR ANY DAMAGE CAUSED BY AN INCORRECT USE OF THE PRODUCT.**



## DISTRIBUTORI OLEODINAMICI DIRECTIONAL CONTROL VALVES

DISTRIBUTORI MONOBLOCCO  
MONOBLOCK DIRECTIONAL CONTROL VALVES



A

DISTRIBUTORI COMPONENTI  
SECTIONAL DIRECTIONAL CONTROL VALVES



B

DISTRIBUTORI A COMANDO ELETTRICO DIRETTO  
CON FIANCATA PROPORZIONALE  
DIRECTIONAL CONTROL VALVE WITH DIRECT  
ELECTRICAL CONTROL AND PROPORTIONAL SECTION



C

edizione - edition: **2015.00**

## DISTRIBUTORI MONOBLOCCO MONOBLOCK DIRECTIONAL CONTROL VALVES





<b>CARATTERISTICHE</b> <b>FEATURES</b>	A-2
<b>CARATTERISTICHE TECNICHE</b> <b>TECHNICAL CHARACTERISTICS</b>	A-3
<b>ESEMPIO DI ORDINAZIONE IN CODICE</b> <b>ORDERING CODE EXAMPLE</b>	A-5
<b>Q35</b>	A-6
<b>Q15</b>	A-8
<b>GMV15</b>	A-10
<b>Q25</b>	A-12
<b>Q45</b>	A-14
<b>Q65</b>	A-16
<b>Q75</b>	A-18
<b>Q95</b>	A-20

### CARATTERISTICHE

- Elevate prestazioni tecniche che consentono una vasta applicazione.
- Corpo in ghisa speciale ad alta resistenza per essere adatto alle alte pressioni di lavoro.
- Cursori nichelati ad alto scorrimento che permettono di poter lavorare ad alte pressioni con lunga durata di vita.
- Il circuito standard in parallelo offre manovre simultanee e, grazie a ricoprimenti negativi e metering dedicati, si ottengono movimenti proporzionali agli utilizzi.
- Trafilamenti di valore ridottissimo.
- Intercambiabilità dei cursori, anche con quelli dei distributori componibili aventi schema "parallelo" o "singolo".
- Possibilità di inversione del lato di comando ruotando il cursore di 180°, consentendo così unificazione, versatilità, bassi valori di particolari a magazzino.
- Il tipo di libera circolazione a "Y" permette alte portate con basse perdite di carico, in rapporto alle ridotte dimensioni del distributore.
- Fa eccezione Q35 che ha ricoprimento positivo e una gamma di cursori apposita, sempre intercambiabili tra loro.

### CHARACTERISTICS

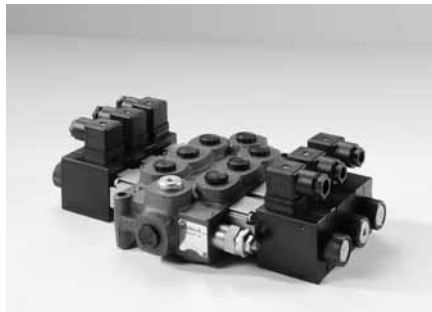
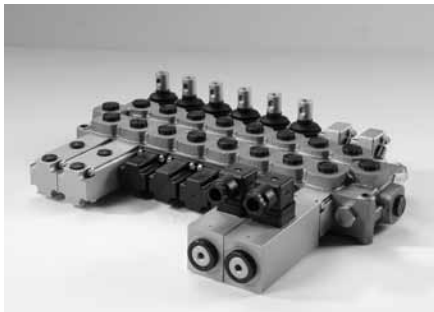
- *High technical performances granting larger application range.*
- *Special high resistance cast-iron body, suitable for high working pressures.*
- *Nickel-plated offering granting long working life under high pressure conditions (see attached scheme).*
- *Standard circuit in parallel grants simultaneous operations, and due to negative overlaps and dedicate metering, there is proportional movement at the working ports.*
- *Minimal internal leakages.*
- *Interchangeability of the spools also with the ones of the sectional valves with "parallel" or "single" scheme*
- *Possibility to reverse the control side, turning the spool of 180° permits unification, versatility and low value of some parts in stock.*
- *Free movement version "Y shape" allows high oil flow with low pressure drops, in relation with the small dimensions of the control valves.*
- *Above features not valid for Q35 having positive overlap. The Q35 spools are interchangeable.*



### AVVERTENZA PER L'INSTALLAZIONE DEI DISTRIBUTORI

- I tre piedini dei distributori devono sempre appoggiare su una superficie perfettamente piana
- Non utilizzare raccordi conici su filetti cilindrici.
- Per pulire il distributore, prima della verniciatura, non utilizzare diluenti/solventi o qualsiasi prodotto che possa intaccare le parti in gomma.

### NOTES FOR DIRECTIONAL CONTROL VALVES ASSEMBLY

- *The three feet of the valve must always and perfectly rest on a 180° degree flat surface.*
- *No conical nipples with JIC thread must be used.*
- *Before painting the control valve, do not use diluents or any products that could damage rubber parts.*

## CARATTERISTICHE TECNICHE

## TECHNICAL CHARACTERISTICS

	Q35	Q15	GMV15	Q25	Q45	Q65	Q75	Q95
<b>Numero massimo di sezioni di lavoro</b> <i>Working sections maximum</i>	1	1	4	8	1	6	6	
<b>Limiti temperatura olio</b> <i>Oil temperature range</i>	-30 ÷ 80 °C							
<b>Temperatura olio consigliata</b> <i>Recommended oil temperature</i>	30° ÷ 60 °C							
<b>Filtraggio consigliato</b> <i>Recommended filtration</i>	26/23µm ISO DIS 4406							
<b>Fluido</b> <i>Hdraulic fluid</i>	Olio minerale <i>Mineral oil</i>							
<b>Viscosità</b> <i>Viscosity</i>	10 ÷ 400 mm <sup>2</sup> /s							

		Massa [Kg] <i>Weight (lbs)</i>						
		Q35	Q15	GMV15	Q25	Q45	Q65	Q75
<b>Massa [Kg]</b> <i>Weight (lbs)</i>	<b>1</b> Sezione di lavoro <i>Working section</i>	1.85 (4.1)	1.20 (2.6)	—	3.00 (6.6)	3.40 (7.5)	5.70 (12.6)	5.70 (12.6)
	<b>2</b> Sezioni di lavoro <i>Working sections</i>	—	—	2.50 (5.5)	4.50 (9.9)	—	7.60 (16.8)	7.60 (16.8)
	<b>3</b> Sezioni di lavoro <i>Working sections</i>	—	—	3.15 (6.9)	5.60 (12.3)	—	10.40 (22.9)	10.40 (22.9)
	<b>4</b> Sezioni di lavoro <i>Working sections</i>	—	—	3.80 (8.4)	7.30 (16.1)	—	12.40 (27.3)	12.40 (27.3)
	<b>5</b> Sezioni di lavoro <i>Working sections</i>	—	—	—	8.90 (19.6)	—	14.50 (32.0)	14.8 (32.6)
	<b>6</b> Sezioni di lavoro <i>Working sections</i>	—	—	—	10.1 (22.3)	—	16.60 (36.6)	18.3 (40.4)
	<b>7</b> Sezioni di lavoro <i>Working sections</i>	—	—	—	11.0 (24.3)	—	—	—
	<b>8</b> Sezioni di lavoro <i>Working sections</i>	—	—	—	13.6 (30.0)	—	—	—

<b>Pressioni massime di lavoro [bar]</b> <i>Max working pressure (PSI)</i>	<b>1 o 2 sezioni di lavoro</b> <i>from 1 up to 2 sections</i>	300 (4350)	250 (3625)	280 (4060)	350 (5075)	350 (5075)	350 (5075)	350 (5075)
	<b>3 sezioni</b> <i>3 sections</i>	—	—	280 (4060)	320 (4640)	—	300 (4350)	300 (4350)
	<b>da 4 a 8 sezioni</b> <i>from 4 up to 8 sections</i>	—	—	280 (4060)	300 (4350)	—	270 (3915)	270 (3915)
<b>Pressione massima sullo scarico [bar]</b> <i>Max back pressure (PSI)</i>	25 (363)							
A richiesta, solo su monoblocco 1 o 2 sezioni, contropressione sullo scarico 180 bar (indicare la lettera "S" al termine del codice) On request, 1 or 2 section monoblock valve only, max back pressure allowable is 2610 PSI (indicate the letter "S" at the end of code)		•	—	—	•	•	—	—

## ESEMPIO DI ORDINAZIONE IN CODICE ORDERING CODE EXAMPLE

Tipo Type	Fiancata d'ingresso Inlet section			2x	Sezione di lavoro Working section			Fiancata di scarico Outlet section	Note aggiuntive Additional notes	
<b>Q25</b>	<b>F7S</b>	<b>R250</b>	<b>MSE</b>		<b>103</b>	<b>A1</b>	<b>M1</b>	<b>F3D</b>	<b>12V</b>	<b>2E</b>
<b>1</b>	<b>2</b>	<b>3</b>	<b>4</b>		<b>5</b>	<b>6</b>	<b>7</b>	<b>8</b>	<b>9</b>	<b>10</b>

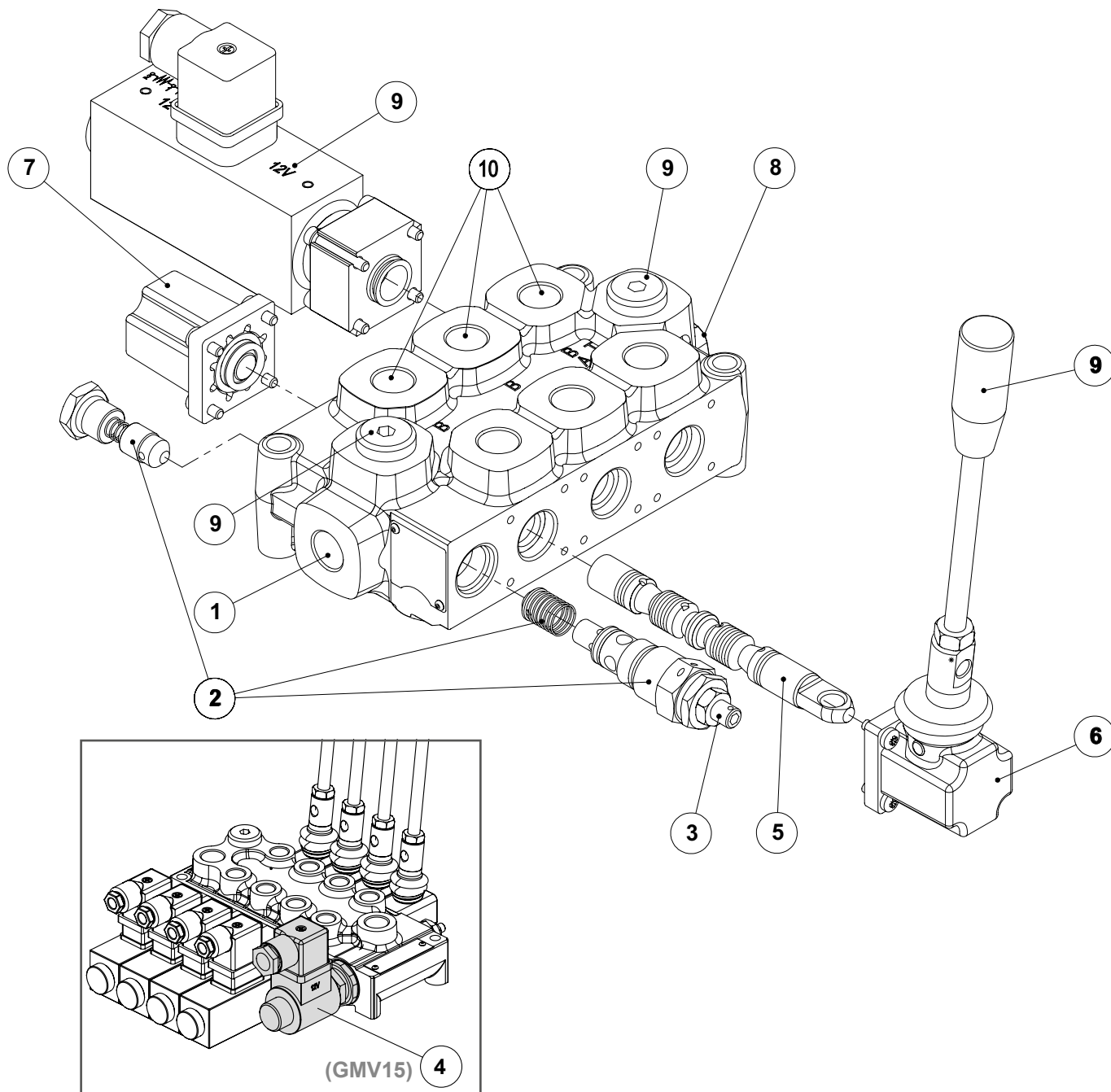

## ESEMPIO DI ORDINAZIONE IN CODICE ORDERING CODE EXAMPLE

### Tipo

**1 - Tipo**  
**Q35, Q15, GMV15, Q25, Q45, Q65, Q75, Q95**

Indica il tipo di distributore; le caratteristiche dimensionali sono riportate da pag. A6 a pag. A21.

### Type

**1 - Type**  
**Q35, Q15, GMV15, Q25, Q45, Q65, Q75, Q95**

*Indicates model valve, characteristics and dimensions found on pages A6 to page A21.*

### Fiancata d'ingresso

**2 - Tipo fiancata d'ingresso** (pag. A-22)

**3 - Tipo molla e taratura valvola** (pag. A-22)

Dove è presente la valvola VLP (fiancate F1S e F7S), deve essere specificato il tipo di molla (**B, N o R**) e la sua pressione di taratura; se quest'ultima viene omessa verrà montata la molla N tarata a **150** bar.

**4 - Valvole aggiuntive alla fiancata di ingresso** (pag. A-23).

### Inlet section

**2 - Inlet section type** (page A-22)

**3 - Type of spring and valve setting** (page A-22)

*If valve VLP is installed (inlet section F1S and F7S), specify the type of spring (**B, N or R**) and its pressure setting. If omitted, spring N with a **150** bar setting will be installed.*

**4 - Additional valves on the inlet section** (page A-23)

### Sezione di lavoro

I campi da 4 a 6 sono da ripetere per ogni sezione. Nel caso in cui due sezioni contigue siano identiche, è sufficiente descriverne solo una antepoendo **2x** al campo 4.

N.B. Il numero massimo complessivo di sezioni di lavoro sono indicate a pag. A3.

**5 - Tipo cursore** (pag. A-24)

**6 - Tipo di comando** (pag. A-28, A-32)

**7 - Tipo posizionatore** (pag. A-35)

### Working section

*Fields 4 to 6 must be repeated for each section. If two adjacent sections are identical, just describe one and put **2x** before field 4.*

*NOTE. The maximum overall number of working sections is indicated on page A3.*

**4 - Spool type** (page A-24)

**5 - Control type** (page A-28, A-32)

**6 - Positioner type** (page A-35)

### Fiancata di scarico

**8 - Tipo fiancata di scarico** (pag. A-62)

### Outlet section

**7 - Outlet section type** (page A-62)

### Note aggiuntive

**9 - Note aggiuntive** (pag. A-63)

**10 - Numero elementi** (pag. A-63)

Specificare il numero delle sezioni di lavoro (es. 2E) previste.

### Additional notes

**8 - Additional notes** (page A-63)

**9 - Number of sections** (page A-63)

*Specify the number of working sections needed (e.g. 2E).*



# Q35

## DISTRIBUTORI MONOBLOCCO MONOBLOCK DIRECTIONAL CONTROL VALVES

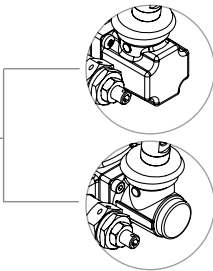
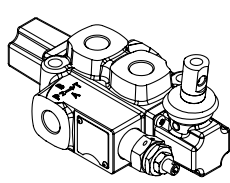

(Standard)  
Comando e posizionario in plastica  
*Control and positioner plastic*

**S**  
Comando e posizionario in Alluminio  
*Control and positioner Aluminium*

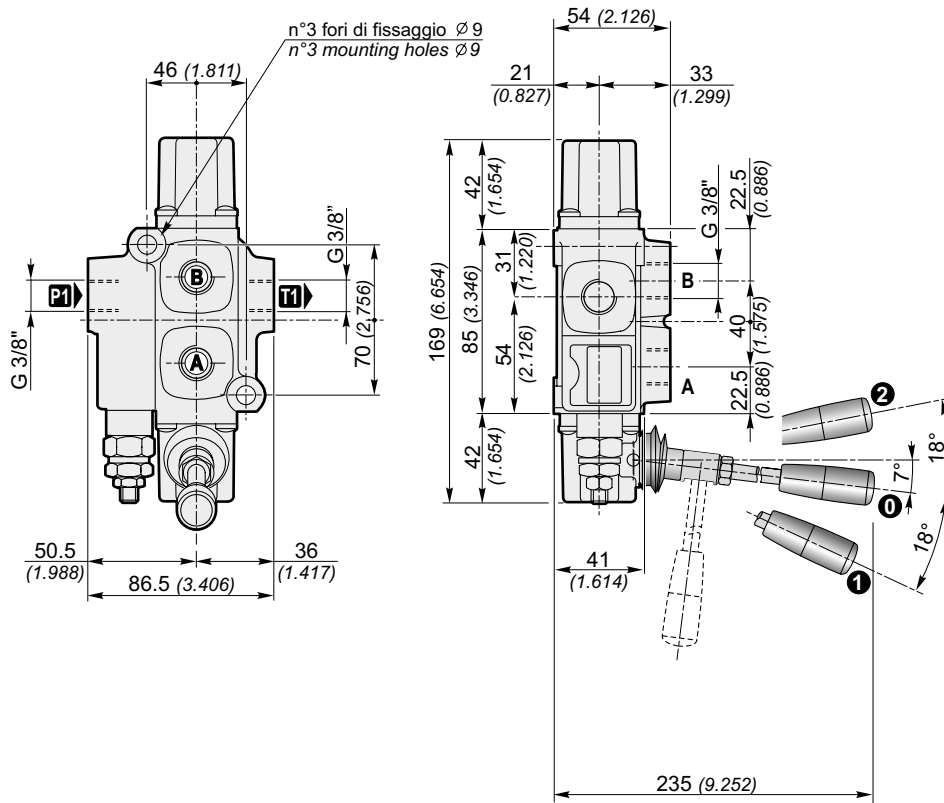

Filettature disponibili / Available ports

Bocche Ports	BSP (standard)	SAE	BSP G 1/2"
<b>P1</b>	G 3/8"	3/4" - 16 UNF (SAE8)	BSP G 1/2"
<b>A-B</b>	G 3/8"	3/4" - 16 UNF (SAE8)	BSP G 1/2"
<b>T1</b>	G 3/8"	3/4" - 16 UNF (SAE8)	BSP G 1/2"

Dimensioni in / Dimensions in: mm (inch)

# Q35

## DISTRIBUTORI MONOBLOCCO MONOBLOCK DIRECTIONAL CONTROL VALVES

**Perdite di carico con il cursore in posizione neutra**  
*Pressure drop with spool in neutral position*

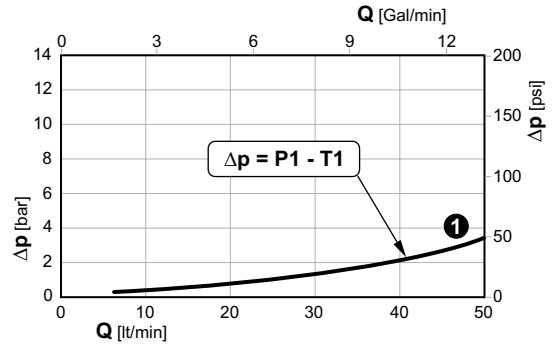
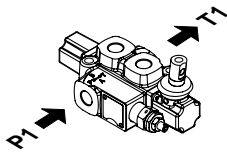

**Perdite di carico con il cursore in posizione di lavoro**  
*Pressure drop with spool in working position*

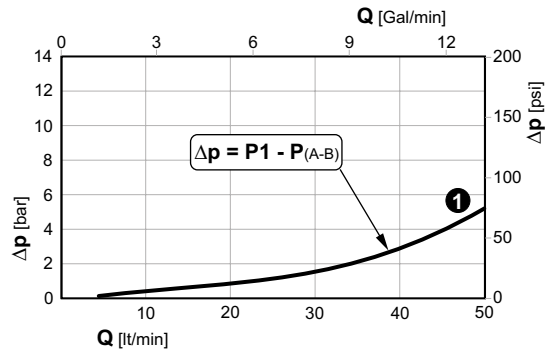
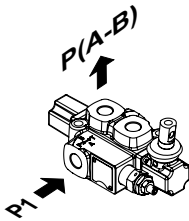

**Perdite di carico con il cursore in posizione di lavoro**  
*Pressure drop with spool in working position*

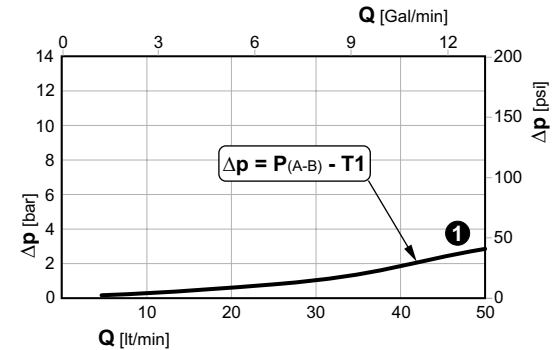
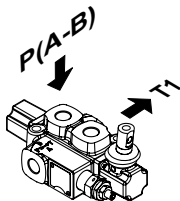

1 Sezioni / Sections

**Curve di progressività**  
*Spool metering*

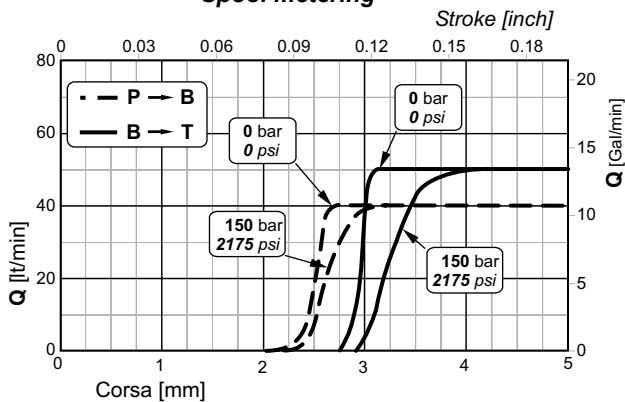

**Trafilamenti sul cursore**  
*Spool leakage*

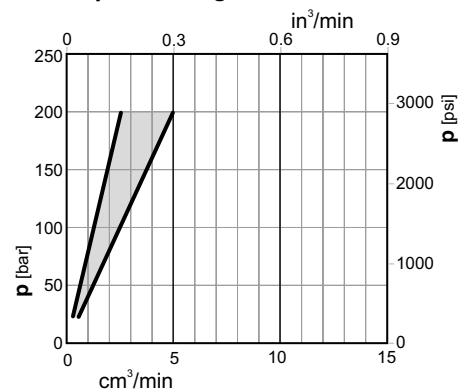

N.B. Le curve sono ricavate con cursore 103 / NOTE. Performance curves measured using spool 103 type.

**Q15**

**DISTRIBUTORI MONOBLOCCO  
MONOBLOCK DIRECTIONAL CONTROL VALVES**

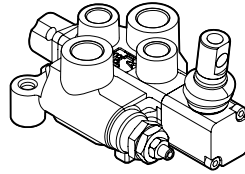

n°2 fori di fissaggio  $\varnothing 7$   
n°2 mounting holes  $\varnothing 7$

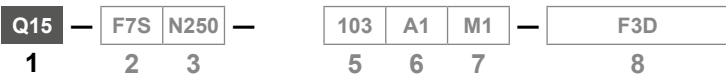
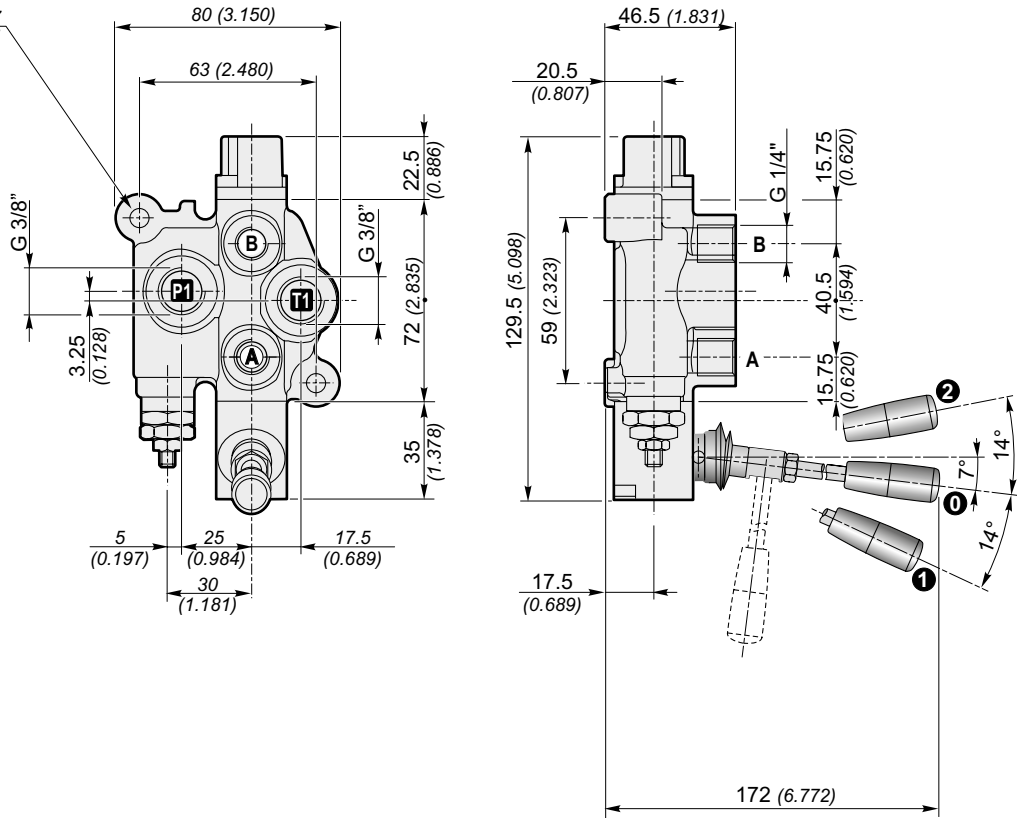

Filettature disponibili / Available ports

Bocche Ports	BSP (standard)	SAE
<b>P - T</b>	G 3/8"	3/4" - 16UNF (SAE 8)
<b>A - B</b>	G 1/4"	9/16" - 18UNF (SAE 6)

# Q15

## DISTRIBUTORI MONOBLOCCO MONOBLOCK DIRECTIONAL CONTROL VALVES

**Perdite di carico con il cursore in posizione neutra**  
*Pressure drop with spool in neutral position*

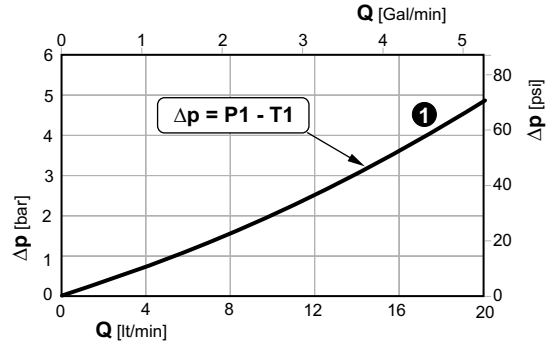
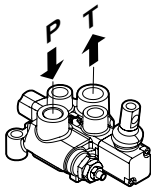

**Perdite di carico con il cursore in posizione di lavoro**  
*Pressure drop with spool in working position*

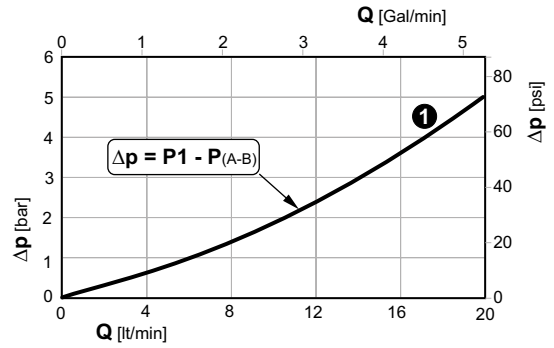
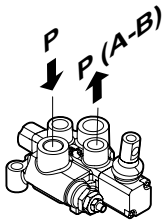

**Perdite di carico con il cursore in posizione di lavoro**  
*Pressure drop with spool in working position*

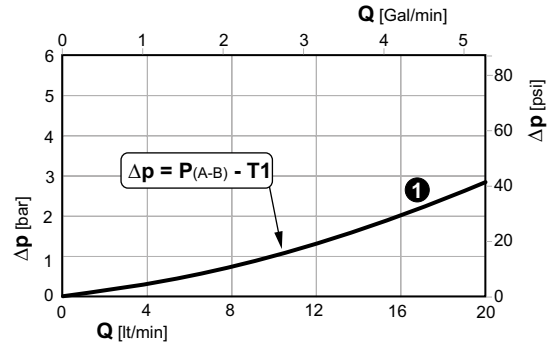
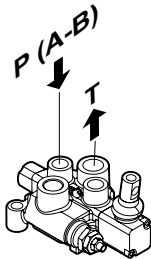

1 Sezioni / Sections

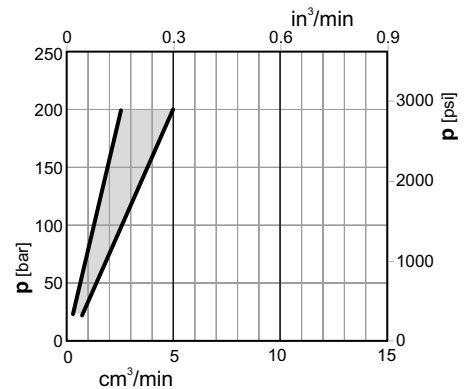
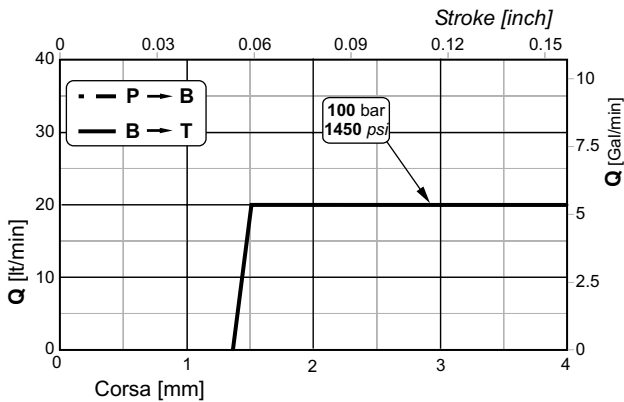

N.B. Le curve sono ricavate con cursore 103 / NOTE. Performance curves measured using spool 103 type.

# GMV15

## DISTRIBUTORI MONOBLOCCO MONOBLOCK DIRECTIONAL CONTROL VALVES

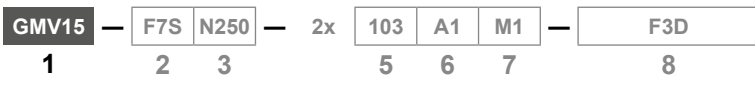
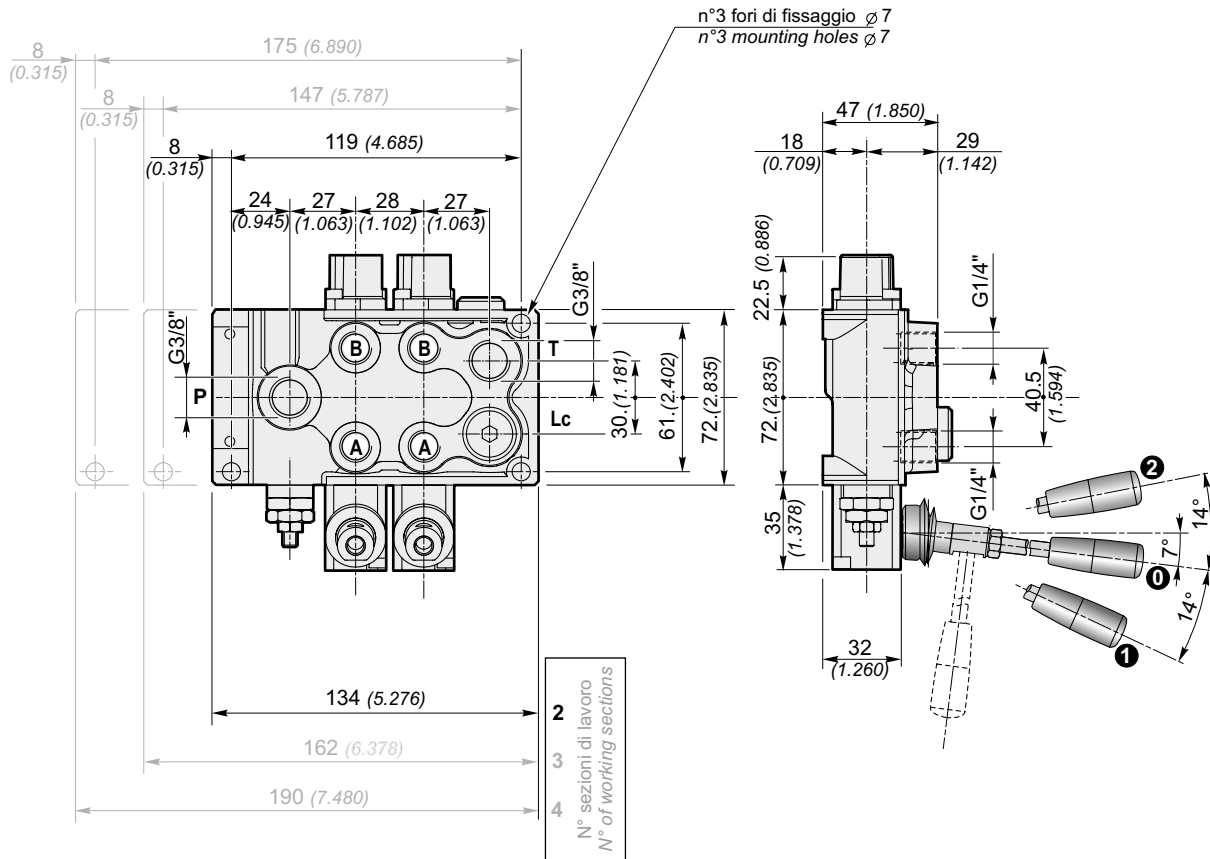
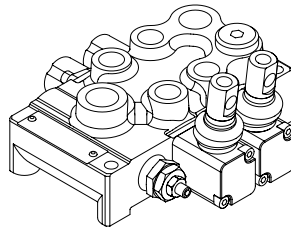

Filettature disponibili / Available ports

Bocche Ports	BSP (standard)	SAE
<b>P</b>	G 3/8"	3/4" - 16UNF (SAE 8)
<b>A - B</b>	G 1/4"	9/16" - 18UNF (SAE 6)
<b>T</b>	G 3/8"	3/4" - 16UNF (SAE 8)
<b>Lc</b>	G 3/8"	3/4" - 16UNF (SAE 8)

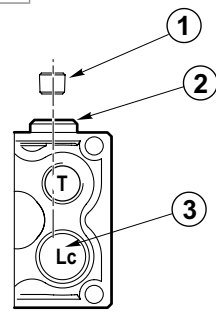

**Come fare la funzione carry-over**  
Togliere il tappo ② montare il tappo conico G1/8" ① e rimontare il tappo ②. Togliere il tappo della libera circolazione ③.

**Come fare la funzione centro chiuso**  
Togliere il tappo ② montare il tappo conico G1/8" ① e rimontare il tappo ②. Montare il tappo della libera circolazione ③.

**How to make the carry-over function**  
Remove the plug ② mount a conical plug G1/8" ① and reassemble the plug ②. Remove the plug on the carry-over port ③.

**How to make the closed center function**  
Remove the plug ② mount a conical plug G1/8" ① and reassemble the plug ②. Mounting the plug on the carry-over port ③.

# GMV15

## DISTRIBUTORI MONOBLOCCO MONOBLOCK DIRECTIONAL CONTROL VALVES

**Perdite di carico con il cursore in posizione neutra**  
*Pressure drop with spool in neutral position*

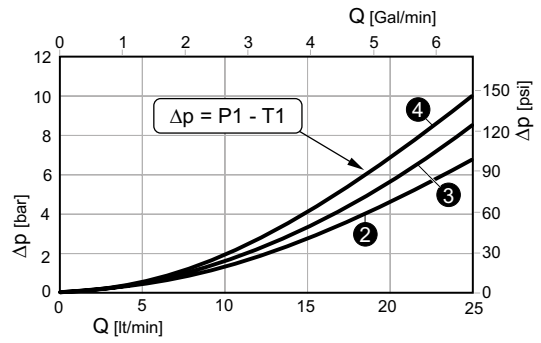
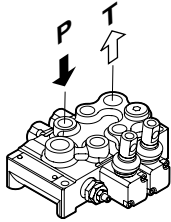

**Perdite di carico con il cursore in posizione di lavoro**  
*Pressure drop with spool in working position*

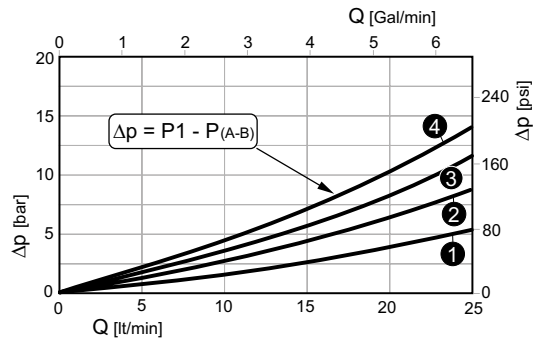
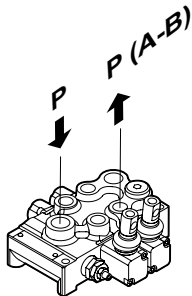

**Perdite di carico con il cursore in posizione di lavoro**  
*Pressure drop with spool in working position*

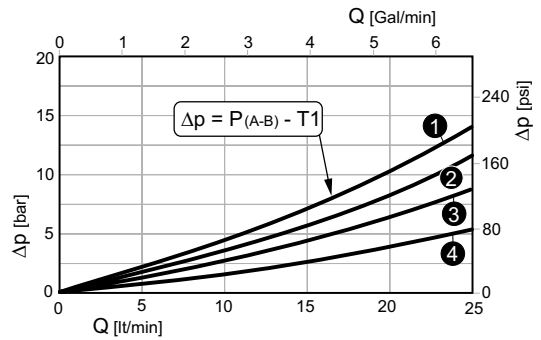
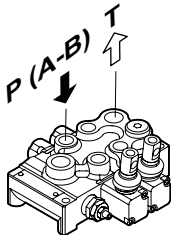

1 2 3 4 Sezioni / Sections

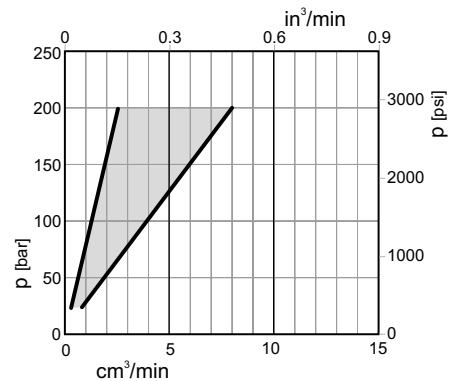
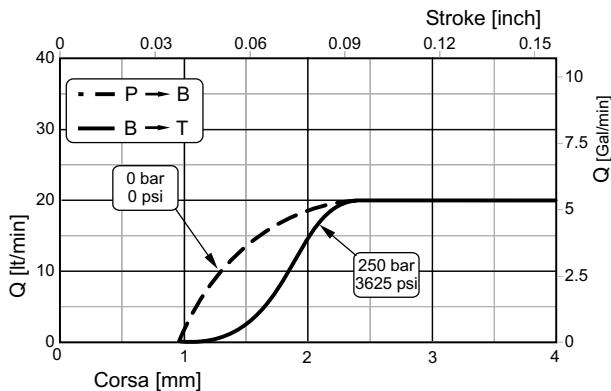

N.B. Le curve sono state effettuate con olio Tellus 46 a 40 °C e cursore 103.  
NOTE. The tests were performed with Tellus 46 oil to 40 °C and spool 103 type.

# Q25

## DISTRIBUTORI MONOBLOCCO MONOBLOCK DIRECTIONAL CONTROL VALVES

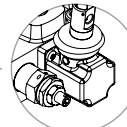
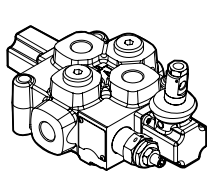

(Standard)  
Comando e posizionatore in plastica  
Control and positioner plastic

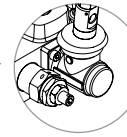

**S**  
Comando e posizionatore in Alluminio  
Control and positioner Aluminium

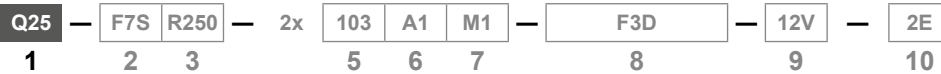
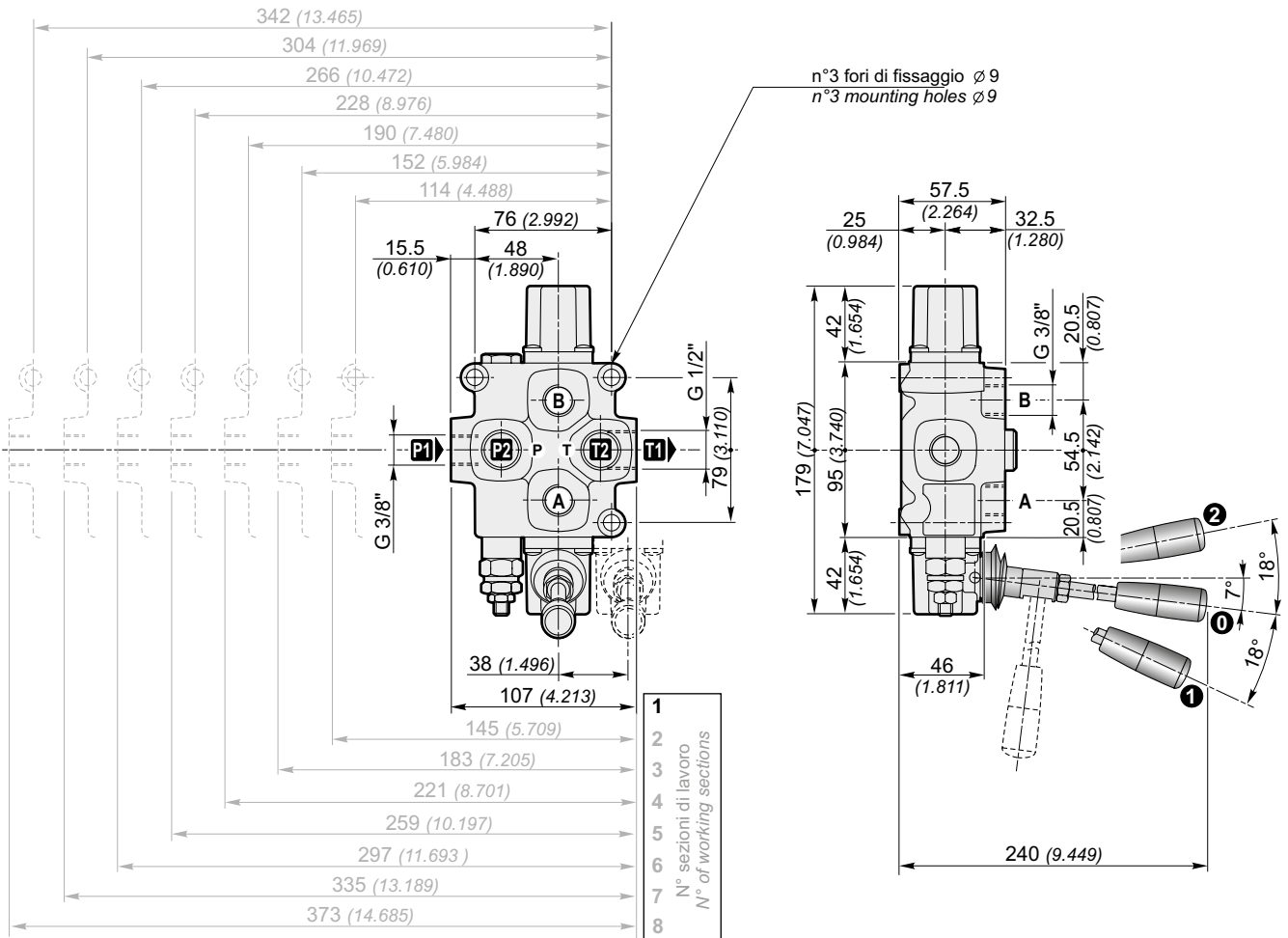

Filettature disponibili / Available ports

Bocche Ports	BSP (standard)	SAE
<b>P1</b>	G 3/8"	9/16" - 18UNF (SAE 6)
<b>P2</b>	G 3/8"	9/16" - 18UNF (SAE 6)
<b>A-B</b>	G 3/8"	9/16" - 18UNF (SAE 6)
<b>T1</b>	G 1/2"	7/8" - 14UNF (SAE 10)
<b>T2</b>	G 3/8"	9/16" - 18UNF (SAE 6)

Tappo per carry-over (su uscita T1)  
Carry-over plug (on T1 port)

	T1	X	
	G 1/2"	7/8"-14UNF (SAE 10)	G 3/8" G 1/2" 3/4" - 16UNF (SAE 8)

# Q25

## DISTRIBUTORI MONOBLOCCO MONOBLOCK DIRECTIONAL CONTROL VALVES

**Perdite di carico con il cursore in posizione neutra**  
( $\Delta p$  in funzione del numero di sezioni attraversate)  
**Pressure drop with spool in neutral position**  
( $\Delta p$  depending on the number of the crossed sections)

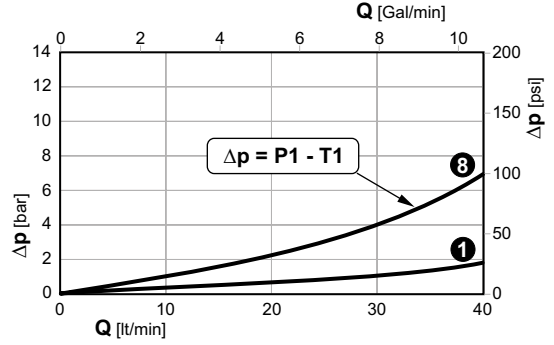
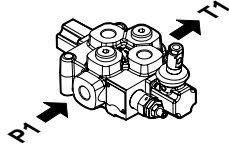

**Perdite di carico con il cursore in posizione di lavoro**  
( $\Delta p$  in funzione del numero di sezioni attraversate)  
**Pressure drop with spool in working position**  
( $\Delta p$  depending on the number of the crossed sections)

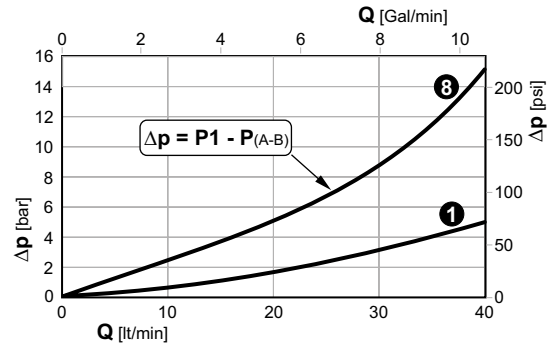
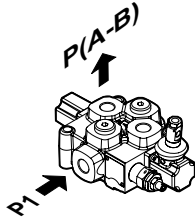

**Perdite di carico con il cursore in posizione di lavoro**  
( $\Delta p$  in funzione del numero di sezioni attraversate)  
**Pressure drop with spool in working position**  
( $\Delta p$  depending on the number of the crossed sections)

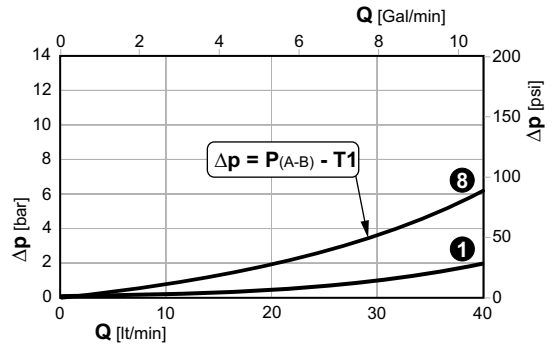
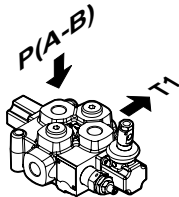

1 8 Sezioni / Sections

**Curve di progressività**  
**Spool metering**

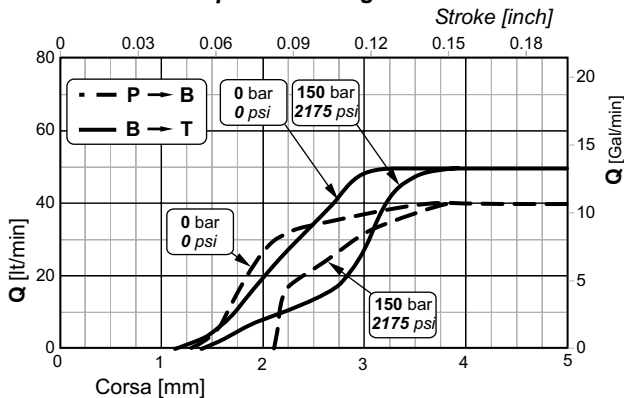

**Trafilamenti sul cursore**  
**Spool leakage**

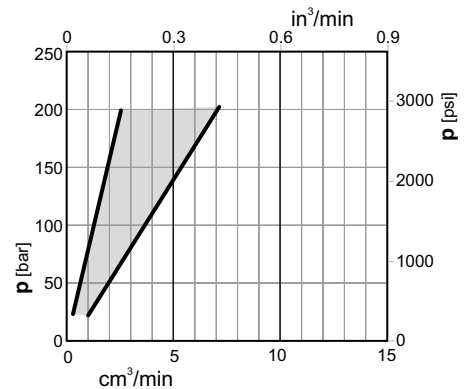

N.B. Le curve sono ricavate con cursore 103 / NOTE. Performance curves measured using spool 103 type.



# Q45

## DISTRIBUTORI MONOBLOCCO MONOBLOCK DIRECTIONAL CONTROL VALVES

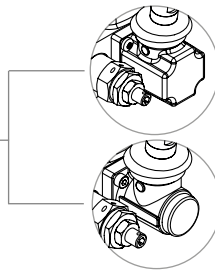
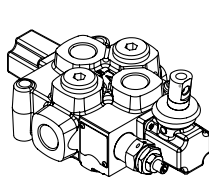

(Standard)  
Comando e posizionate in plastica  
Control and positionner plastic

**S**  
Comando e posizionate in Alluminio  
Control and positionner Aluminium

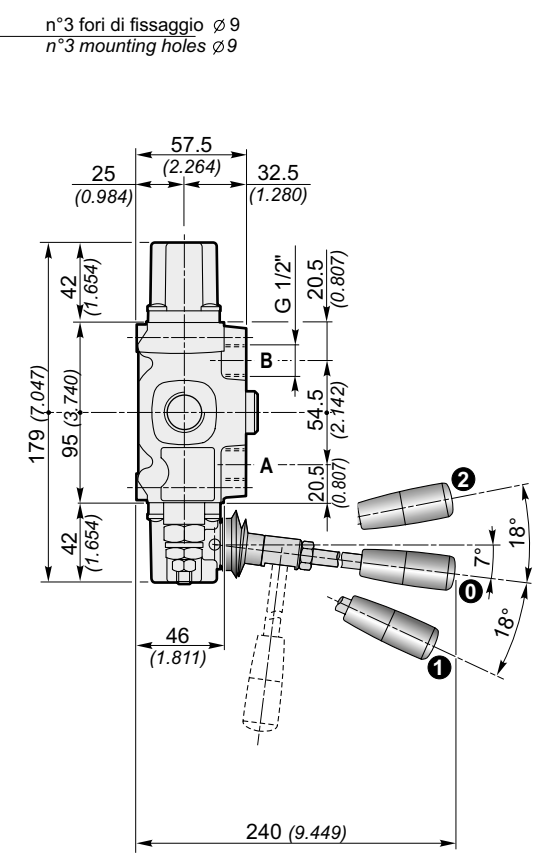
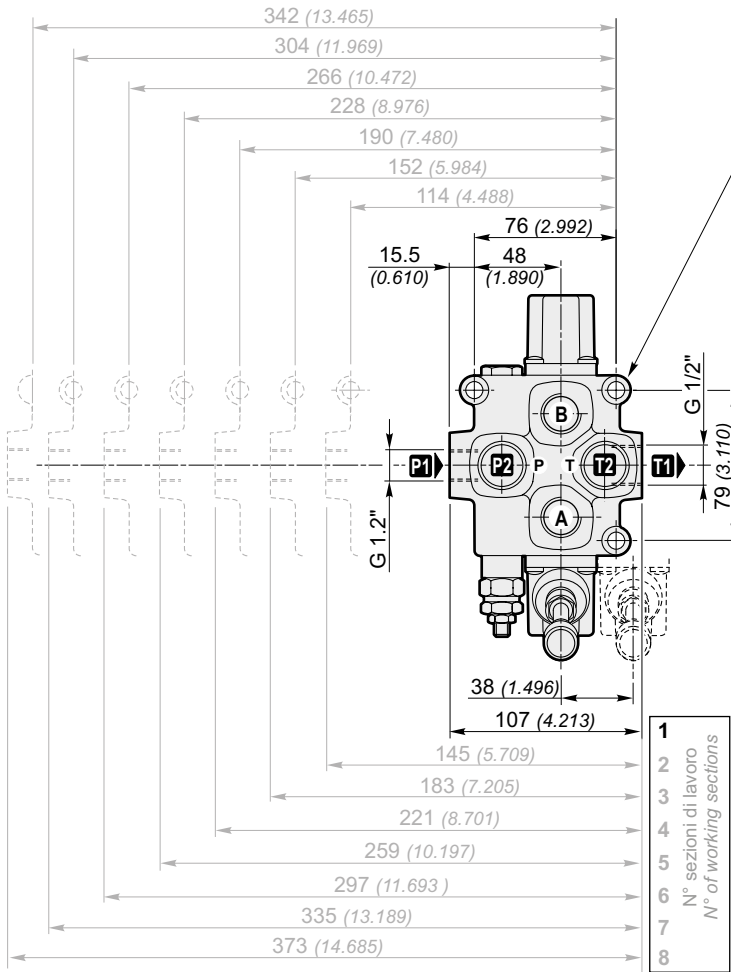
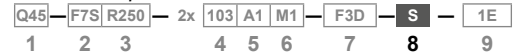

Filettature disponibili / Available ports

Bocche Ports	BSP (standard)	SAE
<b>P1</b>	G 1/2"	3/4" - 16 UNF (SAE 8)
<b>P2</b>	G 1/2"	3/4" - 16 UNF (SAE 8)
<b>A-B</b>	G 1/2"	3/4" - 16 UNF (SAE 8)
<b>T1</b>	G 1/2"	7/8" - 14 UNF (SAE 10)
<b>T2</b>	G 1/2"	3/4" - 16 UNF (SAE 8)

Tappo per carry-over (su uscita T1)  
Carry-over plug (on T1 port)

	T1	X
	G 1/2"	7/8"-14UNF (SAE 10)
		G 3/8" / G 1/2"
		3/4" - 16UNF (SAE 8) / 7/8" - 14UNF (SAE 10)

# Q45

## DISTRIBUTORI MONOBLOCCO MONOBLOCK DIRECTIONAL CONTROL VALVES

**Perdite di carico con il cursore in posizione neutra**  
( $\Delta p$  in funzione del numero di sezioni attraversate)  
**Pressure drop with spool in neutral position**  
( $\Delta p$  depending on the number of the crossed sections)

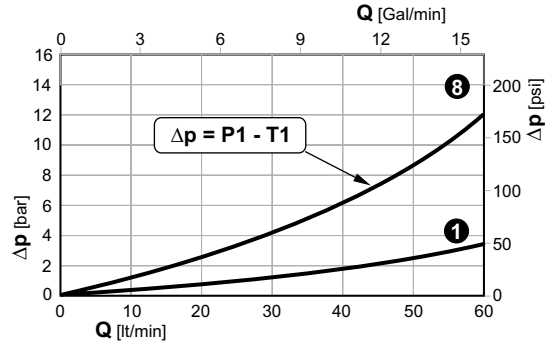
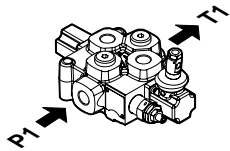

**Perdite di carico con il cursore in posizione di lavoro**  
( $\Delta p$  in funzione del numero di sezioni attraversate)  
**Pressure drop with spool in working position**  
( $\Delta p$  depending on the number of the crossed sections)

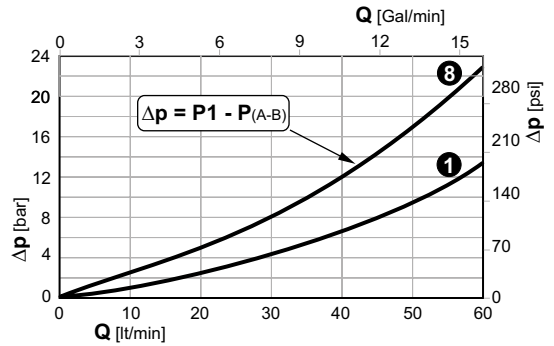
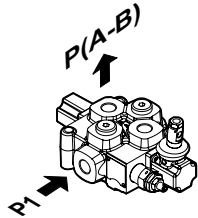

**Perdite di carico con il cursore in posizione di lavoro**  
( $\Delta p$  in funzione del numero di sezioni attraversate)  
**Pressure drop with spool in working position**  
( $\Delta p$  depending on the number of the crossed sections)

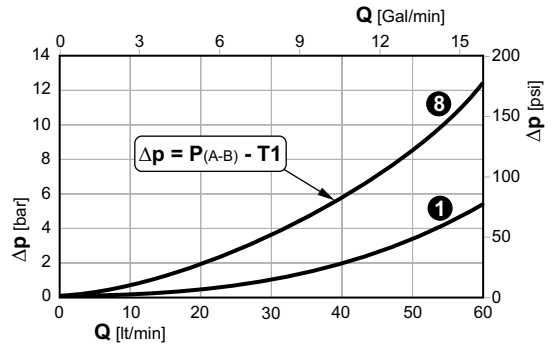
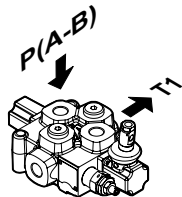

1 8 Sezioni / Sections

**Curve di progressività**  
**Spool metering**

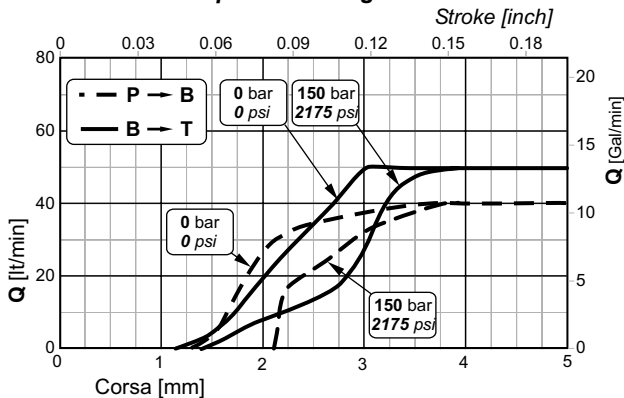

**Trafilamenti sul cursore**  
**Spool leakage**

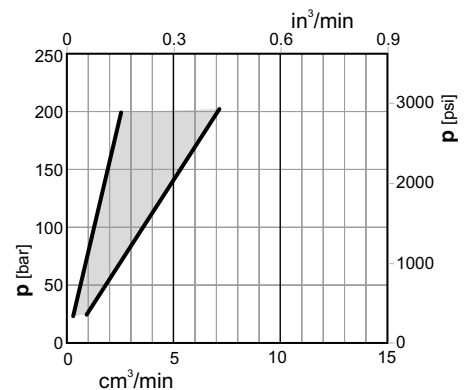

N.B. Le curve sono ricavate con cursore 103 / NOTE. Performance curves measured using spool 103 type.

# Q65

## DISTRIBUTORI MONOBLOCCO MONOBLOCK DIRECTIONAL CONTROL VALVES

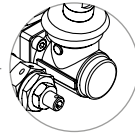
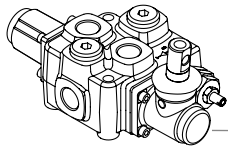

Comando e posizionatore in Alluminio  
Control and positioner Aluminium

Q65 - F7S R250 - 2x 103 A1 M1 - F3D - S - 1E  
1 2 3 4 5 6 7 8 9

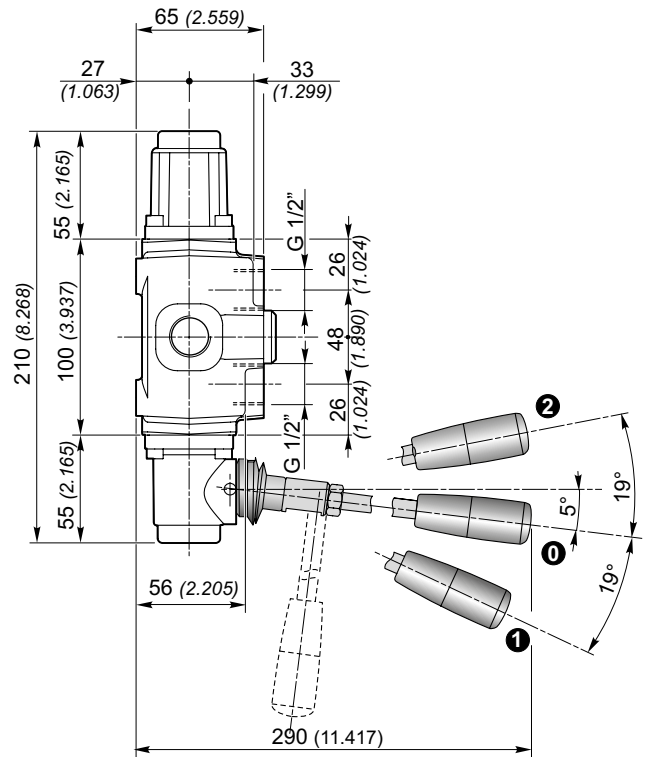
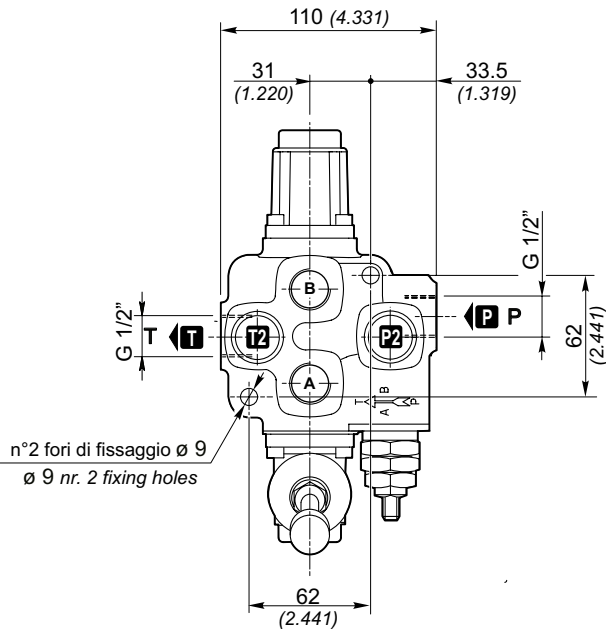

Q65 - F7S R250 - 103 A1 M1 - F3D - 12V  
1 2 3 5 6 7 8 9

Filettature disponibili / Available ports

Bocche Ports	BSP (standard)	SAE
P1	G 1/2"	7/8" - 14 UNF (SAE 10)
P2	G 1/2"	7/8" - 14 UNF (SAE 10)
A-B	G 1/2"	7/8" - 14 UNF (SAE 10)
T1	G 1/2"	7/8" - 14 UNF (SAE 10)
T2	G 1/2"	7/8" - 14 UNF (SAE 10)

Tappo per carry-over (su uscita T1)  
Carry-over plug (on T1 port)

	T1	X
	G 1/2"	7/8"-14UNF (SAE 10)
		G 3/8" G 1/2"
		3/4" - 16UNF (SAE 8) 7/8" - 14UNF (SAE 10)

# Q65

## DISTRIBUTORI MONOBLOCCO MONOBLOCK DIRECTIONAL CONTROL VALVES

**Perdite di carico con il cursore in posizione neutra**  
( $\Delta p$  in funzione del numero di sezioni attraversate)  
**Pressure drop with spool in neutral position**  
( $\Delta p$  depending on the number of the crossed sections)

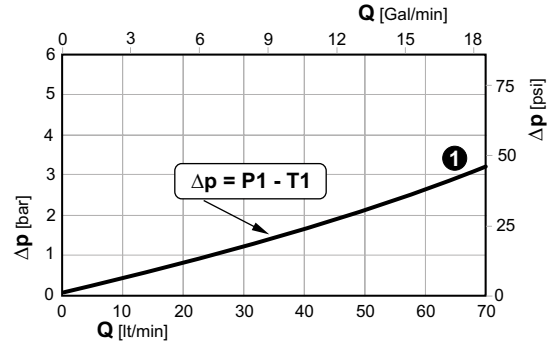
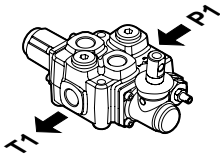

**Perdite di carico con il cursore in posizione di lavoro**  
( $\Delta p$  in funzione del numero di sezioni attraversate)  
**Pressure drop with spool in working position**  
( $\Delta p$  depending on the number of the crossed sections)

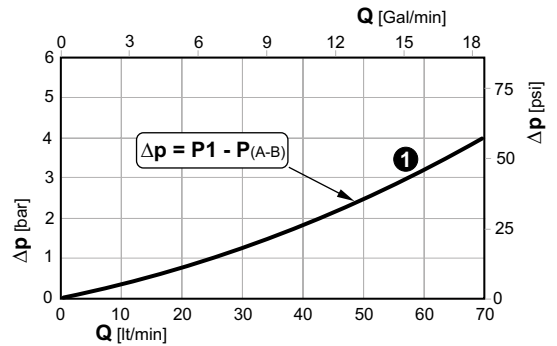
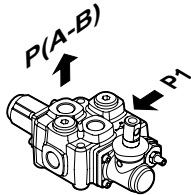

**Perdite di carico con il cursore in posizione di lavoro**  
( $\Delta p$  in funzione del numero di sezioni attraversate)  
**Pressure drop with spool in working position**  
( $\Delta p$  depending on the number of the crossed sections)

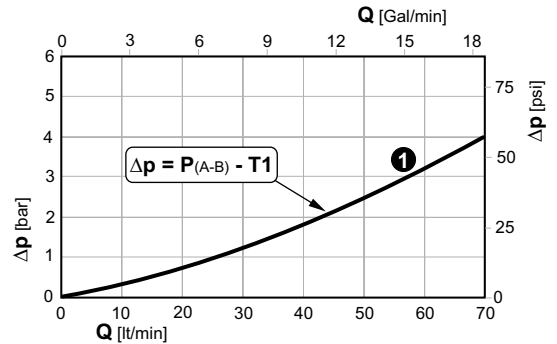
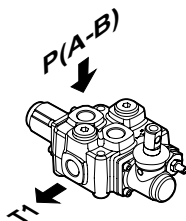

① Sezioni / Sections

**Curve di progressività**  
**Spool metering**

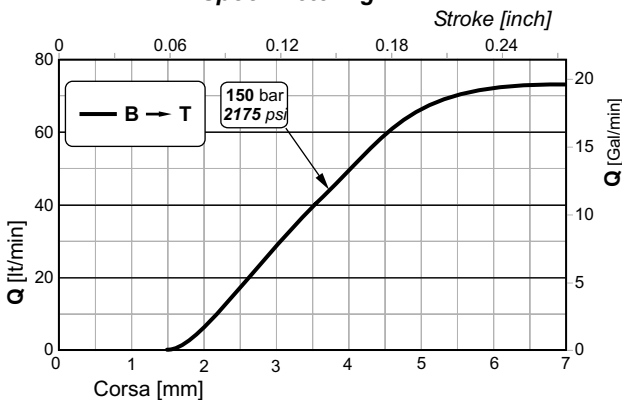

**Trafilamenti sul cursore**  
**Spool leakage**

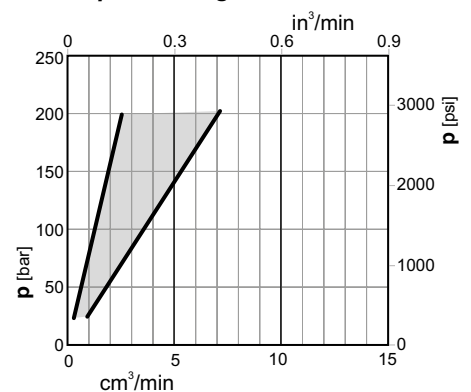

N.B. Le curve sono ricavate con cursore 103 / NOTE. Performance curves measured using spool 103 type.

# Q75

## DISTRIBUTORI MONOBLOCCO MONOBLOCK DIRECTIONAL CONTROL VALVES

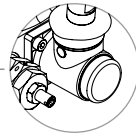
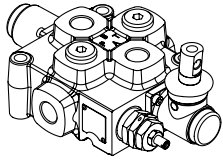

(Standard)  
Comando e posizionatore in Alluminio  
Control and positioner Aluminium

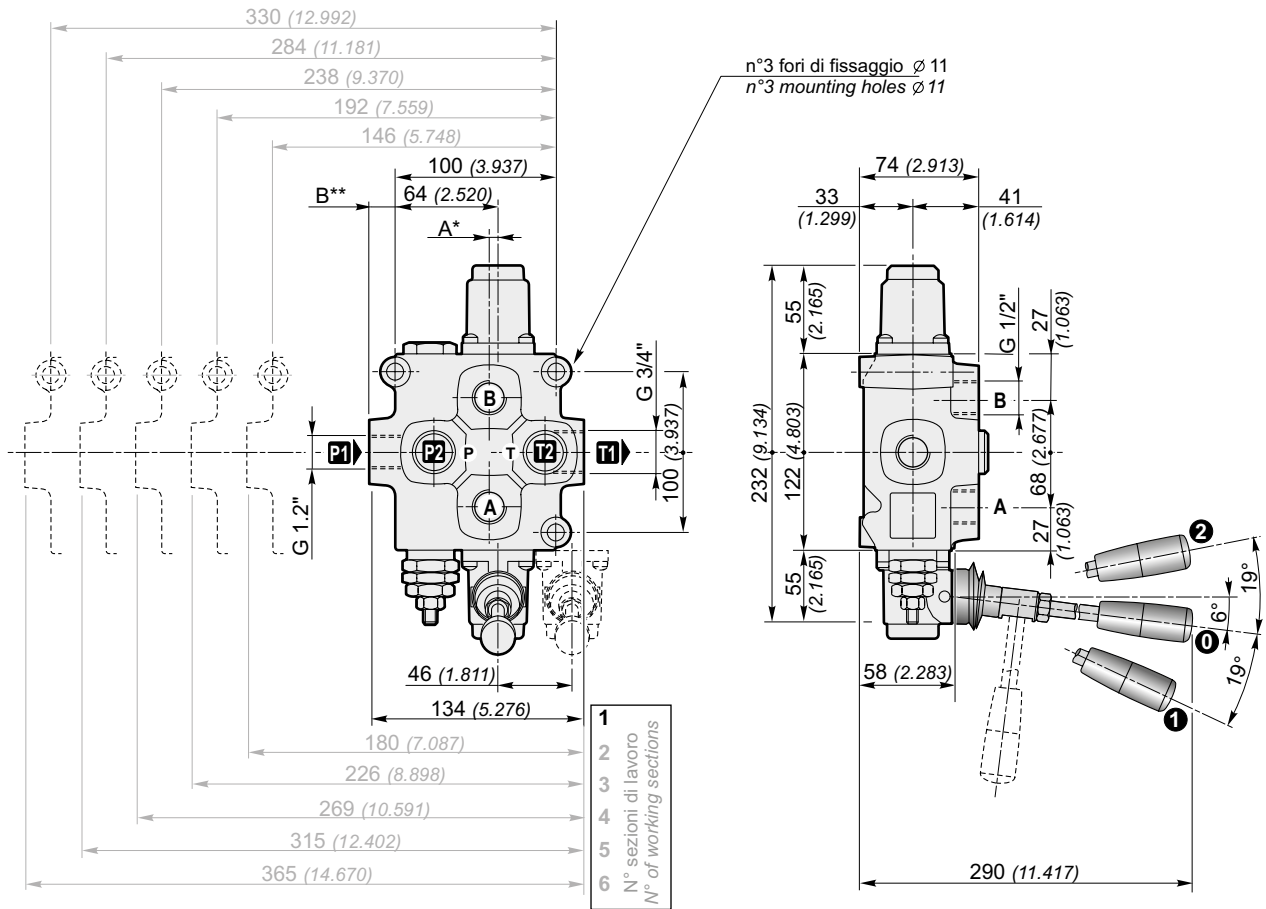

- \* **A=5.5** per monoblocco ad 1 sezione, **A=0** per monoblocchi a 2, 3, 4, 5, 6 sezioni di lavoro
- \* **A =5.5** for 1 working section, **A=0** for 2, 3, 4, 5 and 6 working sections
- \*\* **B=16** per monoblocco ad 1, 2, 3, 6 sezioni, **B=13** per monoblocchi a 4 e 5 sezioni di lavoro
- \*\* **B=16** for 1, 2, 3, 6 working section, **B=13** for 4 and 5 working sections

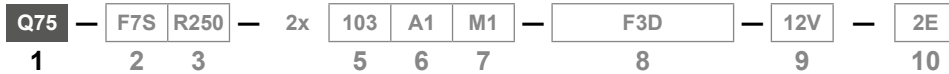

Filettature disponibili / Available ports

Bocche Ports	BSP (standard)	SAE
<b>P1</b>	G 1/2"	7/8" - 14 UNF (SAE 10)
<b>P2</b>	G 1/2"	7/8" - 14 UNF (SAE 10)
<b>A-B</b>	G 1/2"	7/8" - 14 UNF (SAE 10)
<b>T1</b>	G 3/4"	1" 1/16" - 12 UN (SAE 12)
<b>T2</b>	G 1/2"	7/8" - 14 UNF (SAE 10)

Tappo per carry-over (su uscita T1)  
Carry-over plug (on T1 port)

		T1	X	
	G 3/4"	1" 1/16" - 12 UN (SAE 12)	G 1/2"	7/8" - 14 UNF (SAE 10)
			G 3/4"	

# Q75

## DISTRIBUTORI MONOBLOCCO MONOBLOCK DIRECTIONAL CONTROL VALVES

**Perdite di carico con il cursore in posizione neutra**  
( $\Delta p$  in funzione del numero di sezioni attraversate)  
**Pressure drop with spool in neutral position**  
( $\Delta p$  depending on the number of the crossed sections)

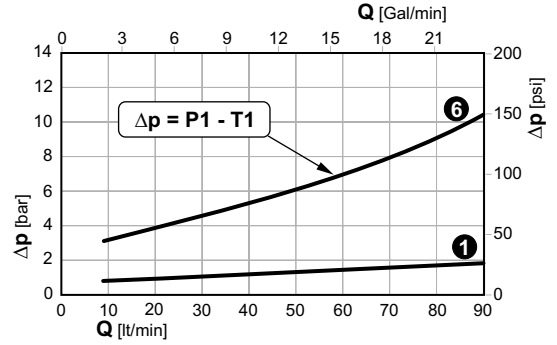
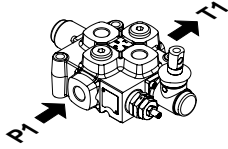

**Perdite di carico con il cursore in posizione di lavoro**  
( $\Delta p$  in funzione del numero di sezioni attraversate)  
**Pressure drop with spool in working position**  
( $\Delta p$  depending on the number of the crossed sections)

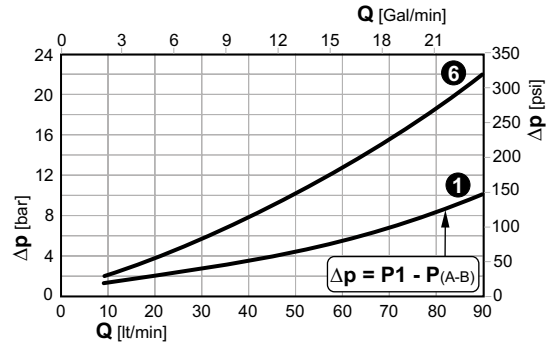
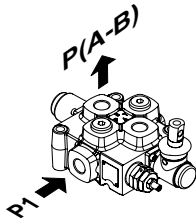

**Perdite di carico con il cursore in posizione di lavoro**  
( $\Delta p$  in funzione del numero di sezioni attraversate)  
**Pressure drop with spool in working position**  
( $\Delta p$  depending on the number of the crossed sections)

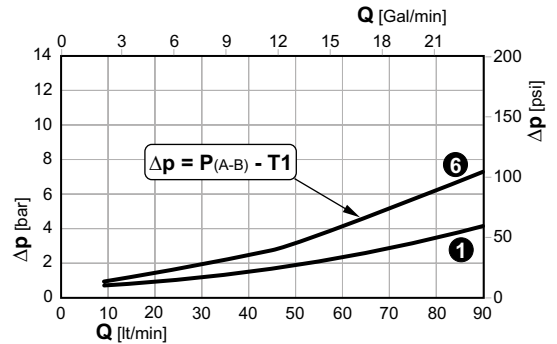
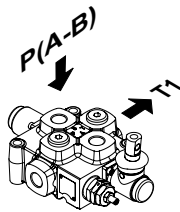

1 6 Sezioni / Sections

**Curve di progressività**  
**Spool metering**

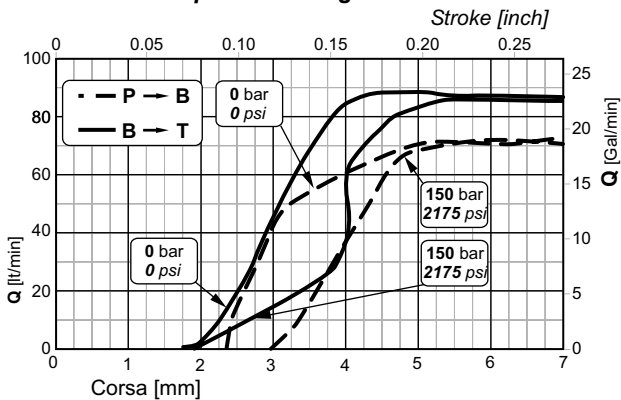

**Trafilamenti sul cursore**  
**Spool leakage**

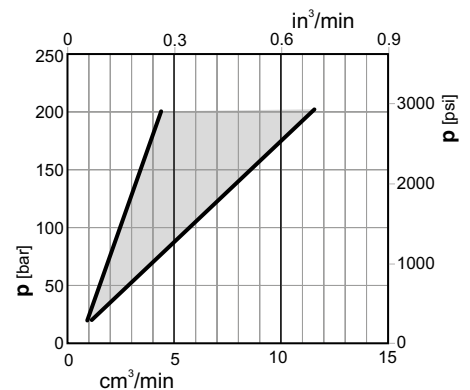

N.B. Le curve sono ricavate con cursore 103 / NOTE. Performance curves measured using spool 103 type.

# Q95

## DISTRIBUTORI MONOBLOCCO MONOBLOCK DIRECTIONAL CONTROL VALVES

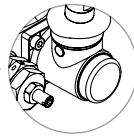
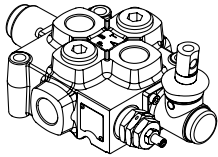

(Standard)  
Comando e posizionario in Alluminio  
Control and positioner Aluminium

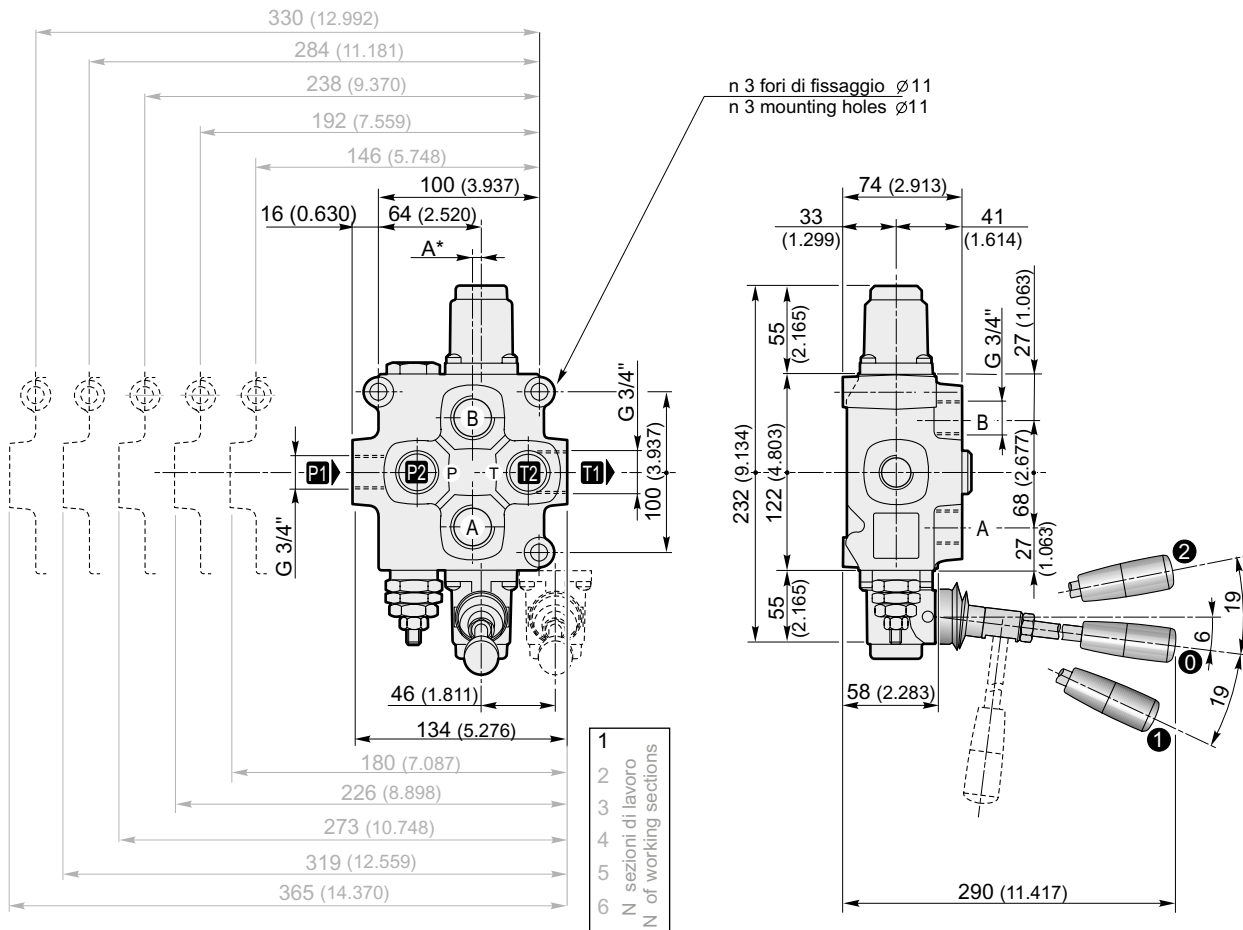

\* **A= 5.5** per monoblocco a 1 sezione; **A=0** per monoblocco a 2-3-5-6 sezioni di lavoro  
\* **A= 5.5** for 1 working section, **A=0** for 2-3-5-6 working section



Filettature disponibili / Available ports

Bocche Ports	BSP (standard)	SAE
<b>P1</b>	G 3/4"	1" 1/16" - 12 UN (SAE 12)
<b>P2</b>	G 3/4"	1" 1/16" - 12 UN (SAE 12)
<b>A-B</b>	G 3/4"	1" 1/16" - 12 UN (SAE 12)
<b>T1</b>	G 3/4"	1" 1/16" - 12 UN (SAE 12)
<b>T2</b>	G 3/4"	1" 1/16" - 12 UN (SAE 12)

Tappe per carry-over (su uscita T1)  
Carry-over plug (on T1 port)

		T1	X	
	G 3/4"	1" 1/16" - 12 UN (SAE 12)	G 3/4"	7/8" - 14 UNF (SAE 10)

# Q95

## DISTRIBUTORI MONOBLOCCO MONOBLOCK DIRECTIONAL CONTROL VALVES

**Perdite di carico con il cursore in posizione neutra**  
( $\Delta p$  in funzione del numero di sezioni attraversate)  
**Pressure drop with spool in neutral position**  
( $\Delta p$  depending on the number of the crossed sections)

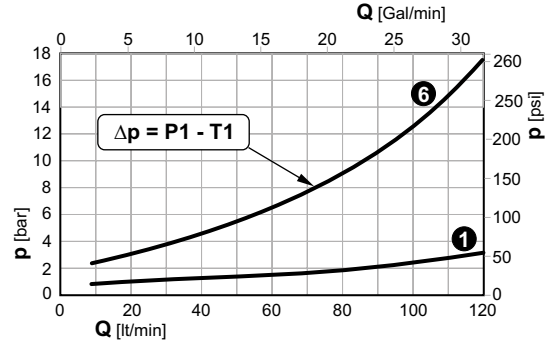
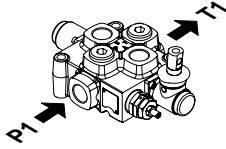

**Perdite di carico con il cursore in posizione di lavoro**  
( $\Delta p$  in funzione del numero di sezioni attraversate)  
**Pressure drop with spool in working position**  
( $\Delta p$  depending on the number of the crossed sections)

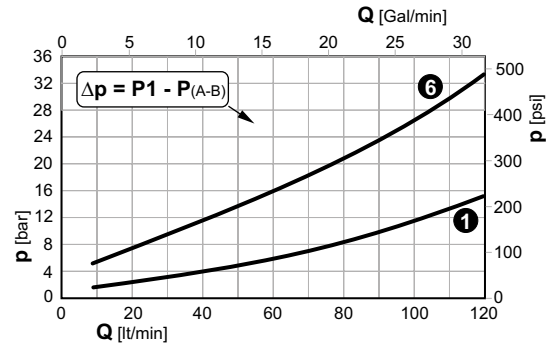
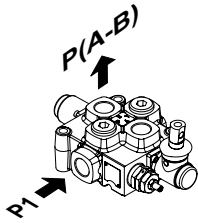

**Perdite di carico con il cursore in posizione di lavoro**  
( $\Delta p$  in funzione del numero di sezioni attraversate)  
**Pressure drop with spool in working position**  
( $\Delta p$  depending on the number of the crossed sections)

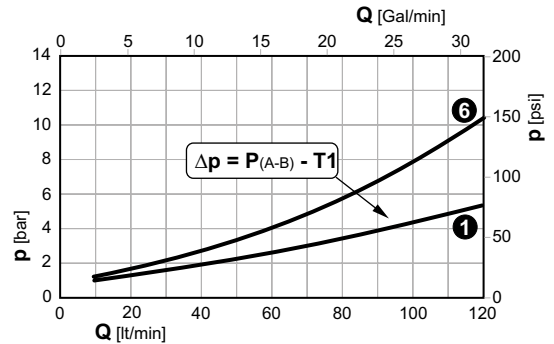
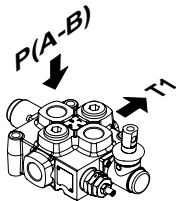

1 6 Sezioni / Sections

**Curve di progressività**  
**Metering spool**

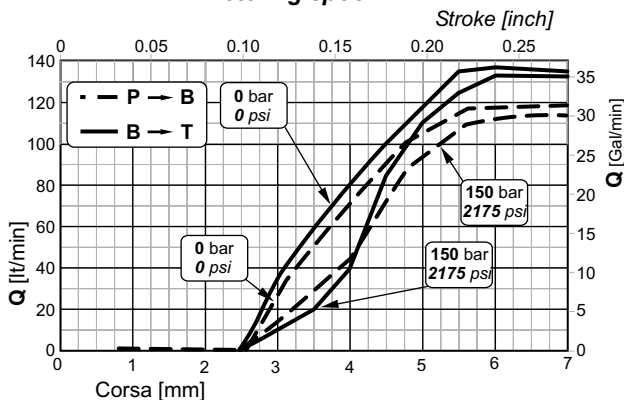

**Trafilamenti sul cursore**  
**Spool leakage**

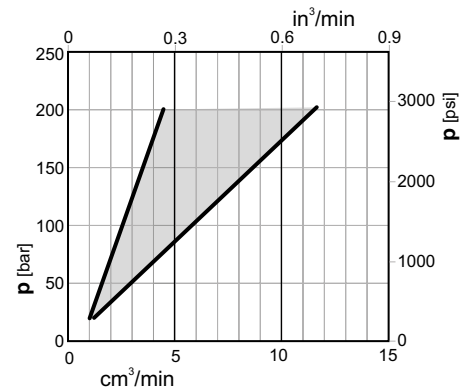

N.B. Le curve sono ricavate con cursore 103 / NOTE. Performance curves measured using spool 103 type.



**Fiancata d'ingresso**

**Inlet section**



**2 - Tipo fiancata d'ingresso / Inlet section type**

	Q35	Q15	GMV 15	Q25	Q45	Q65	Q75	Q95
<b>F1S</b>			•	•	•		•	•
<b>F2S</b>			•	•	•		•	•
<b>F7S</b>	•	•	•	•	•	•	•	•
<b>F8S</b>	•	•	•	•	•	•	•	•

**F1S** F1S/SAE

Collettore di entrata con valvola di ritegno VR e valvola limitatrice di pressione VLP  
*Inlet section with check (VR) and relief valves VLP*

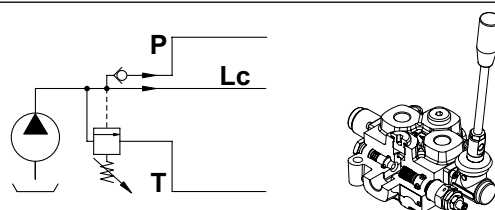

**F7S**

Collettore di entrata con valvola limitatrice di pressione VLP  
*Inlet section with relief valve VLP*

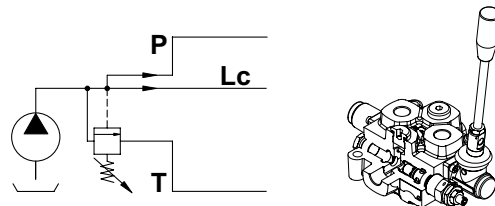

**3 - Tipo molla e taratura valvola**

Dove è presente la valvola VLP (fiancate F1S e F7S), deve essere specificato il tipo di molla (**B**, **N** o **R**) e la sua pressione di taratura; **se quest'ultima viene omessa, verrà messa la molla N tarata a 150 bar.**

**3 - Type of spring and valve setting**

*If valve VLP is installed (inlet section F1S and F7S), specify the type of spring (B, N or R) and its pressure setting. If omitted, spring N with a 150 bar setting will be installed.*

R	Tipo di molla per la VLP Type of spring for relief valve	Campi di taratura / Calibration fields bar (psi)			
		molla bianca white spring	molla nera black spring	molla rossa red spring	
250	Taratura della VLP VLP Setting	35S / 65S / 105S	10 ÷ 80 (145 ÷ 1160)	81 ÷ 200 (1175 ÷ 2900)	201 ÷ 380 (2915 ÷ 5510)
		15S	0 ÷ 120 (0 ÷ 1740)	100 ÷ 280 (1450 ÷ 2900)	—

**F2S**

Collettore di entrata con valvola di ritegno VR  
*Inlet sections with check valve VR*

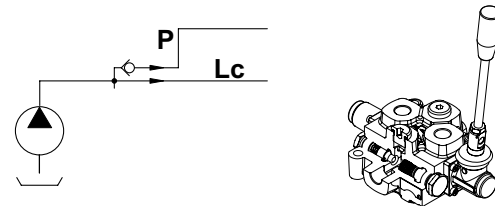

**F8S**

Collettore di entrata senza valvole  
*Inlet section without valves*

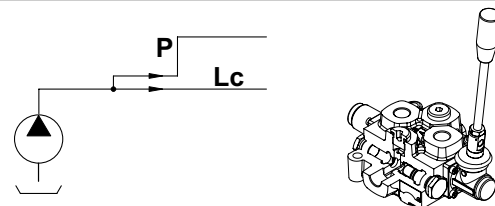

**Fiancata d'ingresso**

**Inlet section**



**4 - Valvole aggiuntive alla fiancata (facoltativo) / Additional valves to the inlet section (optional)**

		Q35	Q15	GMV 15	Q25	Q45	Q65	Q75	Q95
<b>PMS</b>	Collettore di entrata con predisposizione per valvola di messa a scarico elettrica (diretta) <i>Inlet section presets for electrical outlet release valve (direct)</i>			•					
<b>MSE</b>	Collettore di entrata con valvola di messa a scarico elettrica (diretta) <i>Inlet section with electrical outlet release valve (direct)</i>			•					

**PMS**

Collettore di entrata con predisposizione per valvola di messa a scarico elettrica (diretta)  
*Inlet section presets for electrical outlet release valve (direct)*

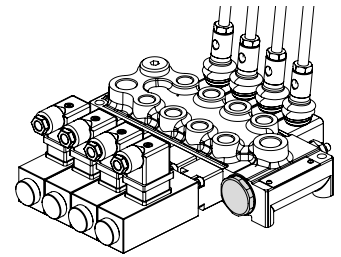
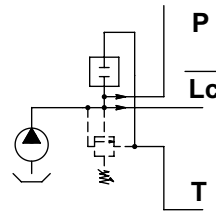

**MSE**

Collettore di entrata con valvola di messa a scarico elettrica (diretta)  
*Inlet section with electrical outlet release valve (direct)*

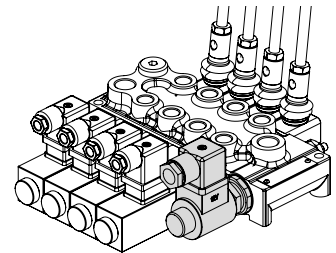
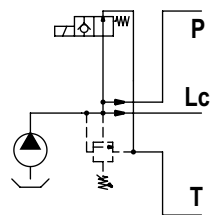

**N.B.**  
Specificare tensione e schema dell'elettrovalvola  
*Specify voltage and type of the solenoid operated valve*

Tensione Voltage	Schema Scheme		
<b>12 V.DC</b>	<b>N.C.</b>	Normalmente chiusa <i>Usually closed</i>	
<b>24 V.DC</b>	<b>N.A.</b>	Normalmente aperta <i>Usually open</i>	

**Perdite di carico del distributore con valvola di messa a scarico elettrica aperta.**  
*Directional control valve pressure drop with electrical outlet release valve open.*

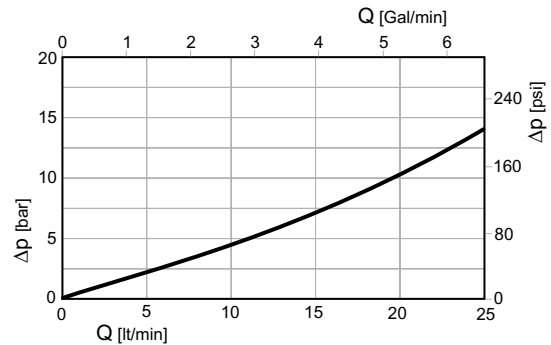

Sezione di lavoro

Working section



5 - Tipo cursore / Spool type

Cursori / Spools

			Q35	Q15	GMV 15	Q25	Q45	Q65	Q75	Q95
101	Semplice effetto in A	Single acting in A port	•	•	•	•	•	•	•	•
102	Semplice effetto in B	Single acting in B port	•	•	•	•	•	•	•	•
103	Doppio effetto, A e B chiusi in posizione 0	Double acting A and B closed in 0 position	•	•	•	•	•	•	•	•
103RN	Doppio effetto a ricoprimento negativo	Double acting with negative overlap	•	•				•		
106	Doppio effetto, passaggi chiusi in posizione 0	Double acting, ports closed in 0 position				•	•		•	•
107	Doppio effetto, A in T e B chiuso in posizione 0	Double acting, A to T and B closed in 0 position				•	•		•	•
108	Doppio effetto, B in T e A chiuso in posizione 0	Double acting, B to T and A closed in 0 position				•	•		•	•
109	Semplice effetto in A, A in T in posizione 0	Single acting in A, A to T in 0 position				•	•		•	•
110	Semplice effetto in B, B in T in posizione 0	Single acting in B, B to T in 0 position				•	•		•	•
111	Doppio effetto, A e B in T in posizione 0	Double acting, A and B to T in 0 position	•	•	•	•	•	•	•	•
114	Doppio effetto, A e B in T e Lc chiusa in posizione 0	Double acting, A and B to T and through passage closed in 0 position				•	•		•	•
116*	Doppio effetto con 4ª posizione flottante	Double acting with 4th position floating		•	•	•	•		•	•
126*	Doppio effetto con 4ª posizione flottante	Double acting with 4th position floating		•	•	•	•		•	•

\* Limitazioni / Limitations

Cursore Spools	Applicabile con: / Applicable with:	
	Comando / Control	Posizionatore / Positioner
116	A1-Z1 / A2-Z1 / A4-Z1 / A6-Z1 / A8-Z1	R8
126	A1 / A2 / A4 / A5 / A6 / A8 / SL / SLA15 / A15 / A16	R10-Z1

**101**

Semplice effetto in A  
Single acting in A port

Q25-Q45  
Q75-Q95

Q15  
Q35  
Q65

**103RN**

Doppio effetto a ricoprimento negativo  
Double acting with negative overlap

**102**

Semplice effetto in B  
Single acting in B port

Q25-Q45  
Q75-Q95

Q15  
Q35  
Q65

**106**

Doppio effetto, passaggi chiusi in posizione 0  
Double acting, ports closed in 0 position

**103**

Doppio effetto, A e B chiusi in posizione 0  
Double acting, A and B closed in 0 position

Q25-Q45  
Q75-Q95

Q15  
Q35  
Q65

**107**

Doppio effetto, A in T e B chiuso in posizione 0  
Double acting, A to T and B closed in 0 position

Sezione di lavoro

Working section

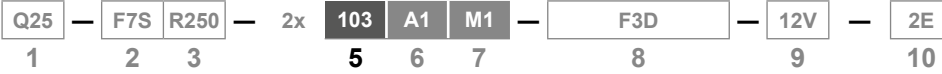

Cursori / Spools

108

Doppio effetto, B in T e A chiuso in posizione 0  
 Double acting, B to T and A closed in 0 position

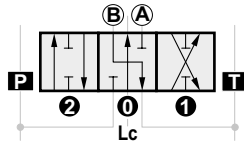

114

Doppio effetto, A e B in T e Lc chiusa in posizione 0  
 Double acting, A and B to T and through passage closed in 0 position

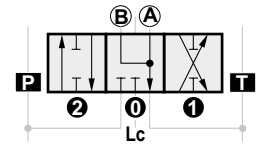

109

Semplice effetto in A, A in T in posizione 0  
 Single acting in A, A to T in 0 position

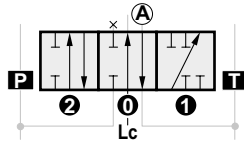

116

Doppio effetto con 4ª posizione flottante  
 Double acting with 4th position floating

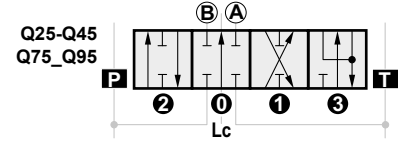

110

Semplice effetto in B, B in T in posizione 0  
 Single acting in B, B to T in 0 position

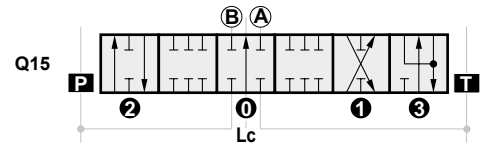
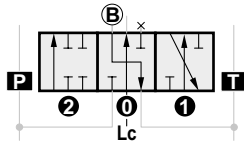

126

Doppio effetto con 4ª posizione flottante  
 Double acting with 4th position floating

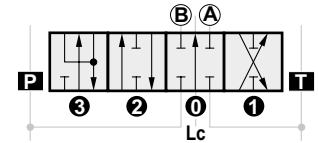

111

Doppio effetto, A e B in T in posizione 0  
 Double acting, A and B to T in 0 position

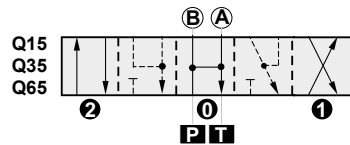
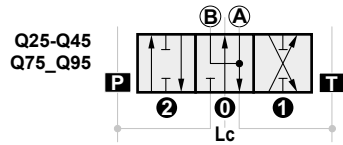

Sezione di lavoro

Working section



Cursori sensibilizzati / Sensitized spools

			Q35	Q25	Q45	Q75	Q95
101.20	Semplice effetto in A	Single acting in A port		•	•	•	•
102.20	Semplice effetto in B	Single acting in B port		•	•	•	•
103.05	Doppio effetto, A e B chiusi in posizione 0	Double acting, A and B closed in 0 position		•	•	•	•
103.10	Doppio effetto, A e B chiusi in posizione 0	Double acting, A and B closed in 0 position				•	•
103.20	Doppio effetto, A e B chiusi in posizione 0	Double acting, A and B closed in 0 position		•	•		
103.25	Doppio effetto, A e B chiusi in posizione 0	Double acting, A and B closed in 0 position		•	•		
103.30	Doppio effetto, A e B chiusi in posizione 0	Double acting, A and B closed in 0 position				•	•
103.40	Doppio effetto, A e B chiusi in posizione 0	Double acting, A and B closed in 0 position		•	•		
107.20	Doppio effetto, A in T e B chiuso in posizione 0	Double acting, A to T and B closed in 0 position		•	•		
108.20	Doppio effetto, B in T e A chiuso in posizione 0	Double acting, B to T and A closed in 0 position		•	•		
111.05	Doppio effetto, A e B in T in posizione 0	Double acting, A and B to T in 0 position		•	•		
111.10	Doppio effetto, A e B in T in posizione 0	Double acting, A and B to T in 0 position				•	•
111.20	Doppio effetto, A e B in T in posizione 0	Double acting, A and B to T in 0 position		•	•		
111.25	Doppio effetto, A e B in T in posizione 0	Double acting, A and B to T in 0 position		•	•		
111.30	Doppio effetto, A e B in T in posizione 0	Double acting, A and B to T in 0 position				•	•
111.40	Doppio effetto, A e B in T in posizione 0	Double acting, A and B to T in 0 position		•	•		

101.20

Semplice effetto in A  
Single acting in A port

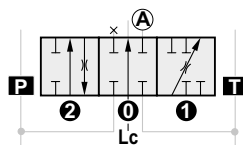

103.20

Doppio effetto, A e B chiusi in posizione 0  
Double acting, A and B closed in 0 position

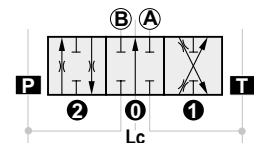

102.20

Semplice effetto in B  
Single acting in B port

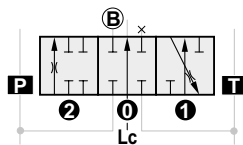

103.25

Doppio effetto, A e B chiusi in posizione 0  
Double acting, A and B closed in 0 position

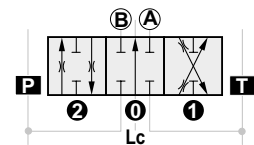

103.05

Doppio effetto, A e B chiusi in posizione 0  
Double acting, A and B closed in 0 position

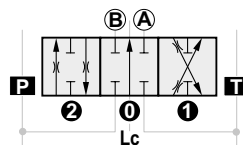

103.30

Doppio effetto, A e B chiusi in posizione 0  
Double acting, A and B closed in 0 position

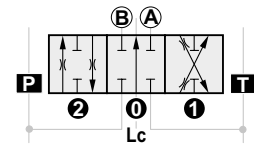

103.10

Doppio effetto, A e B chiusi in posizione 0  
Double acting, A and B closed in 0 position

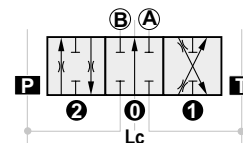

103.40

Doppio effetto, A e B chiusi in posizione 0  
Double acting, A and B closed in 0 position

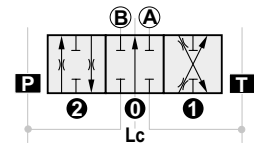

Sezione di lavoro

Working section

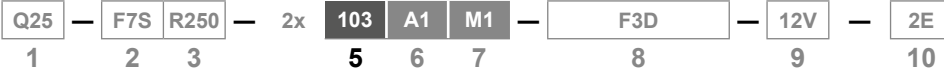

Cursori sensibilizzati / Sensitized spools

107.20

Doppio effetto, A in T e B chiuso in posizione 0  
 Double acting, A to T and B closed in 0 position

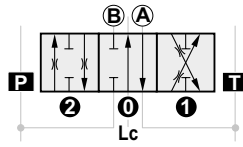

111.20

Doppio effetto, A e B in T in posizione 0  
 Double acting, A and B to T in 0 position

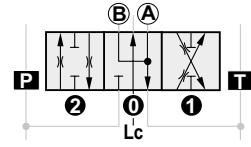

108.20

Doppio effetto, B in T e A chiuso in posizione 0  
 Double acting, B to T and A closed in 0 position

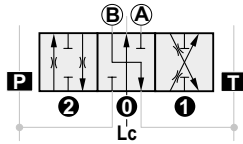

111.25

Doppio effetto, A e B in T in posizione 0  
 Double acting, A and B to T in 0 position

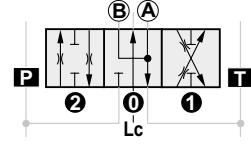

111.05

Doppio effetto, A e B in T in posizione 0  
 Double acting, A and B to T in 0 position

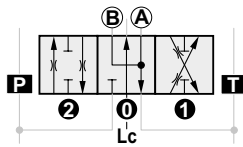

111.30

Doppio effetto, A e B in T in posizione 0  
 Double acting, A and B to T in 0 position

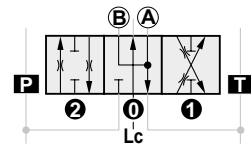

111.10

Doppio effetto, A e B in T in posizione 0  
 Double acting, A and B to T in 0 position

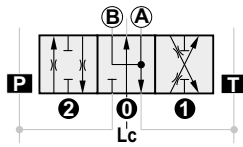

111.40

Doppio effetto, A e B in T in posizione 0  
 Double acting, A and B to T in 0 position

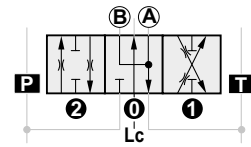

## Sezione di lavoro

## Working section



## 6 - Tipo di comando / Control type

	Q35	Q15 GMV15	Q25	Q45	Q65	Q75	Q95
<b>A1</b>	•	•	•	•	•	•	•
<b>A1/Z1*</b>		•	•	•		•	•
<b>A1S</b>	•		•	•	•	•	•
<b>A2</b>		•	•	•	•	•	•
<b>A2/Z1*</b>		•	•	•		•	•
<b>A2S</b>	•		•	•	•	•	•
<b>A3*</b>			•	•	•	•	•
<b>A4</b>			•	•	•	•	•
<b>A4/Z1*</b>			•	•		•	•
<b>A5</b>	•		•	•	•	•	•
<b>A6</b>	•		•	•	•	•	•
<b>A6/Z1*</b>			•	•		•	•
<b>A8</b>			•	•	•	•	•
<b>A8/Z1*</b>			•	•		•	•
<b>C1*</b>			•	•		•	•
<b>SL*</b>			•	•		•	•
<b>SLA15*</b>			•	•		•	•

## \* Limitazioni / Limitations

Comando Control	Applicabile con: / Applicable with:	
	Comando / Control	Cursore / Spool
<b>A3</b>	M1-U1 / M2-U1 / M3-U1 / M1-U2 / M2-U2 / M3-U2 / D2 / P1-N / P1-NP / D3	Tutti / All
<b>C1</b>		
<b>SL</b>	A8 / M1U2 - M2U2 - M3U2	
<b>SLA15</b>		

Comando Control	Applicabile con: / Applicable with:	
	Posizionatore / Positioner	Cursore / Spool
<b>A1/Z1</b> <b>A2/Z1</b> <b>A4/Z1</b> <b>A6/Z1</b> <b>A8/Z1</b>	R8	116

Sezione di lavoro

Working section



**A1**    **A1/Z1**

A1: Comando manuale con leva standard  
 A1: Hand control with standard lever



A1/Z1: Versione con kit distanziale per il montaggio del cursore 116  
 A1/Z1: Version with spacer kit for installation of spool 116

**A2**    **A2/Z1**

A2: Comando manuale con leva standard ruotata di 180°  
 A2: Hand control with standard lever rotated 180°



A2/Z1: Versione con kit distanziale per il montaggio del cursore 116  
 A2/Z1: Version with spacer kit for installation of spool 116

	A	B	C	D	Z
<b>Q15</b> <b>GMV15</b>	35 (1.378)	211 (8.307)	7°	14°	44 (1.732)
<b>Q35</b> <b>Q25 - Q45</b>	42 (1.654)	211 (8.307)	5°	13°	50.5 (1.988)
<b>Q65</b> <b>Q75 - Q95</b>	55 (2.165)	260 (10.236)	6°	19°	68.5 (2.697)

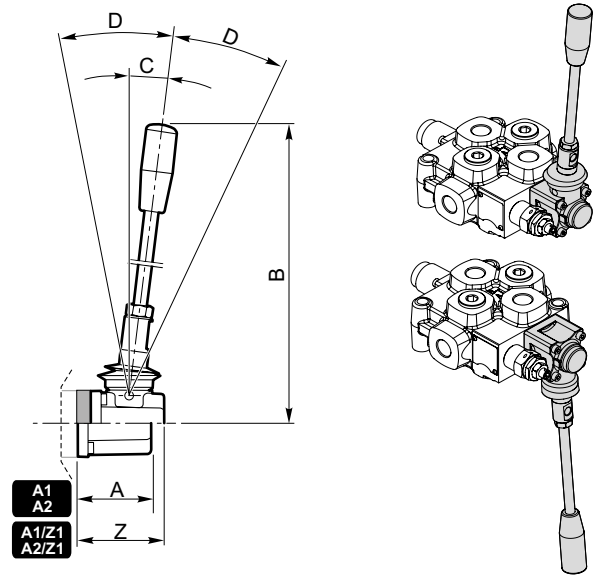

**A1S**

A1S: Comando manuale con leva di sicurezza  
 A1S: Hand control with safety lever

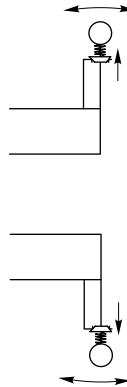

**A2S**

A2S: Comando manuale con leva di sicurezza ruotata di 180°  
 A2S: Hand control with safety lever rotated 180°

	A	B	C	D
<b>Q35</b> <b>Q25 - Q45</b>	42 (1.654)	225 (8.858)	5°	13°
<b>Q65</b> <b>Q75 - Q95</b>	55 (2.165)	256 (10.079)	6°	19°

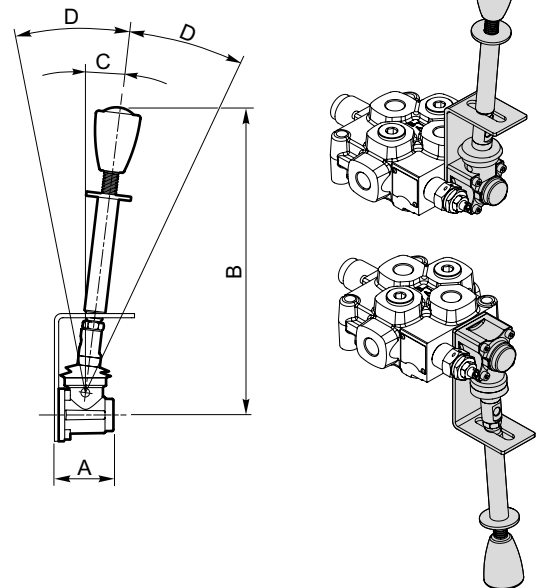

**A3**

Scatola di protezione in sostituzione del comando manuale con leva  
 Proof cap replacing hand control with lever

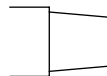

	A
<b>Q25 - Q45</b>	42 (1.654)
<b>Q75 - Q95</b>	55 (2.165)

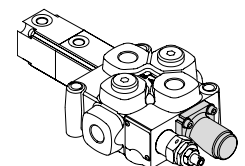



## Sezione di lavoro

## Working section



## A4

## A4/Z1

A4: Attacco diretto sul cursore per rinvio a distanza rigido  
 A4: Direct control connection on spool for stiff remote control

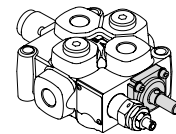
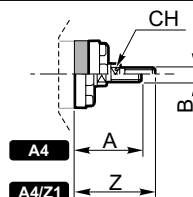
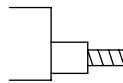

A4/Z1: Versione con kit distanziale per il montaggio del cursore 116  
 A4/Z1: Version with spacer kit for installation of spool 116

	A	B	CH	Corsa Stroke	Z
Q25 - Q45	39 (1.535)	M8	9 (0.354)	±5 (0.197)	47.5 (1.870)
Q65 Q75 - Q95	53 (2.087)	M10	14 (0.551)	±7 (0.276)	66.5 (2.618)

## A5

Attacco diretto sul cursore con terminale sferico (da utilizzare solo con il posizionamento M4 (2-1))  
 Direct control connection on spool with spherical end (Control to be used for positioning M4 (2-1))0

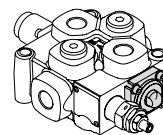
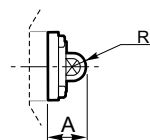
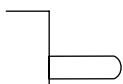

	A	R	Corsa Stroke
Q35 Q25 - Q45	22 (0.866)	6.85 (0.270)	±5 (0.197)
Q65 Q75 - Q95	33 (1.299)	8.75 (0.344)	±7 (0.276)

## A6

## A6/Z1

A6: Attacco diretto sul cursore con terminale ad occhio fisso  
 A6: Direct control connection on spool eye end

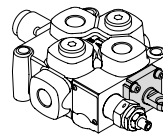
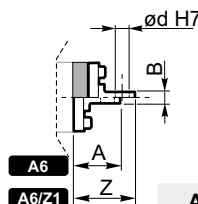
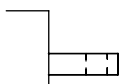

A6/Z1: Versione con kit distanziale per il montaggio del cursore 116  
 A6/Z1: Version with spacer kit for installation of spool 116

	A	B	d	Corsa Stroke	Z
Q35 Q25 - Q45	20 (0.787)	6 (0.236)	9 (0.354)	±5 (0.197)	28.5 (1.122)
Q65 Q75 - Q95	27 (1.063)	7 (0.276)	11 (0.433)	±7 (0.276)	40.5 (1.594)

## A8

## A8/Z1

A8: Attacco diretto sul cursore per cavo flessibile rinvio a distanza  
 A8: Direct connection on spool for remote flexible control

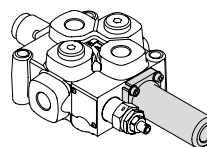
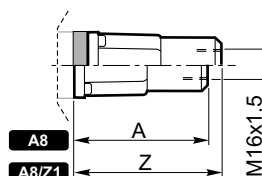
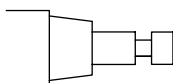

A8/Z1: Versione con kit distanziale per il montaggio del cursore 116  
 A8/Z1: Version with spacer kit for installation of spool 116

	A	Z
Q25 - Q45	73 (2.874)	81.5 (3.209)
Q65 Q75 - Q95	77 (3.031)	90.5 (3.563)

Sezione di lavoro

Working section



C1

Cavo flessibile  
Flexible cable

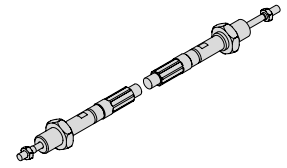
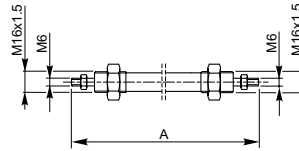
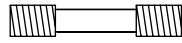

A

Q25 - Q45  
Q75 - Q95

Massima lunghezza cavo consigliata 4000 mm  
Raggio min. di curvatura 200mm  
Max. recommended length 4000 mm  
Minimum radius curve 200 mm

Dove è utilizzato il cavo flessibile C1, è necessario indicare la lunghezza del cavo espressa in mm.  
Esempio per un cavo lungo 1000 mm: **A8-C1x1000-SL**

Indicate the cable length in mm when flexible cable C1 is used.  
E.g.: for a cable 1000 mm in length: **A8-C1x1000-SL**

SL

Comando a distanza  
Remote control

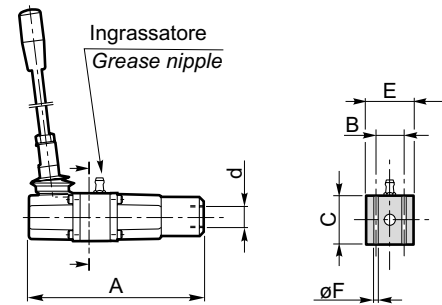
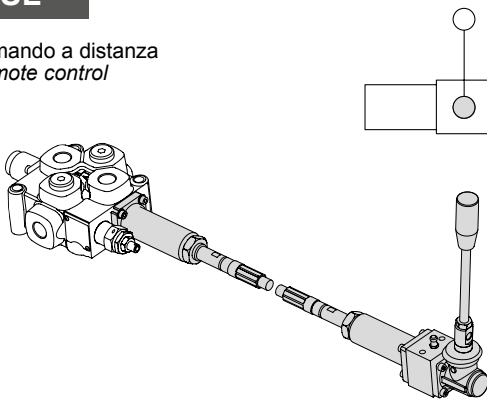

	A	B	C	d	E	F
Q25 - Q45	135 (5.315)	26 (1.024)	40 (1.575)	M16x1.5	38 (1.496)	5.5 (0.217)
Q75 - Q95	172 (6.772)	33.5 (1.319)	45 (1.772)		45 (1.772)	6.5 (0.256)

SLA15

Comando a cloche per controllo simultaneo di due cursori a distanza  
Remote dual axis control for simultaneous operation of two spools

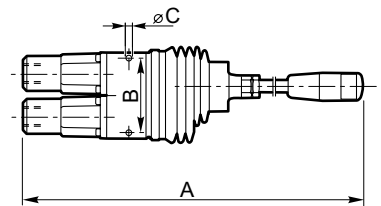
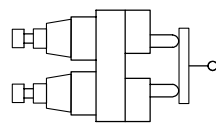

	A	B	Ø d
Q25 - Q45	358 (14.094)	77 (3.031)	6.5 (0.256)
Q75 - Q95			

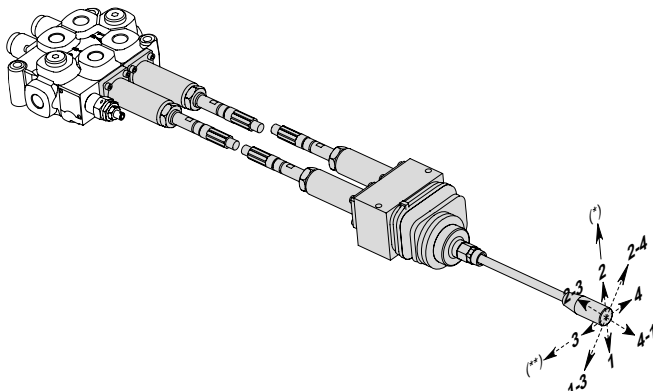

Eventuale cassetto con 4<sup>a</sup> pos. (solo cod.126)  
Optional spool with 4<sup>th</sup> position (only code 126)  
(\* ) su 1<sup>a</sup> sezione / on 1<sup>st</sup> section  
(\*\* ) su 2<sup>a</sup> sezione / on 2<sup>nd</sup> section

Sezione di lavoro

Working section



6 - Tipo di comando / Control type

		Q15 GMV15	Q25	Q45	Q75	Q95
<b>Leva a cloche per il comando singolo o simultaneo di due cursori:</b> <i>Dual axis for single or simultaneous control of two spools:</i>						
<b>A35</b>	- movimento inclinato a X <i>- tilted movement to X</i>	•	•	•	•	•
<b>A16</b>	- movimento dritto a + <i>- straight movement to +</i>		•	•		
<b>Comando manuale con attivazione del contatto elettrico del microswitch centralizzato:</b> <i>Hand control with ON-OFF centralized microswitch operation</i>						
<b>N1-A1</b>	- per doppio effetto <i>- double acting</i>	•	•	•	•	•
<b>N1A-A1</b>	- per semplice effetto in posizione 1 <i>- single acting in 1 position</i>		•	•	•	•
<b>N1B-A1</b>	- per semplice effetto in posizione 2 <i>- single acting in 2 position</i>		•	•	•	•
<b>Comando manuale, ruotato di 180°, con attivazione del contatto elettrico del microswitch centralizzato:</b> <i>180° Rotated hand control with ON-OFF centralized microswitch operation</i>						
<b>N1-A2</b>	- per doppio effetto <i>- double acting</i>	•	•	•	•	•
<b>N1A-A2</b>	- per semplice effetto in posizione 1 <i>- single acting in 1 position</i>		•	•	•	•
<b>N1B-A2</b>	- per semplice effetto in posizione 2 <i>- single acting in 2 position</i>		•	•	•	•
<b>Comando microswitch centralizzato:</b> <i>Centralized microswitch control:</i>						
<b>N1-A3</b>	- per doppio effetto <i>- double acting</i>		•	•	•	•
<b>N1A-A3</b>	- per semplice effetto in posizione 1 <i>- single acting in 1 position</i>		•	•	•	•
<b>N1B-A3</b>	- per semplice effetto in posizione 2 <i>- single acting in 2 position</i>		•	•	•	•

A35

Leva a cloche per il comando singolo o simultaneo di due cursori, come schema a lato  
*Dual axis for simultaneous or single control of two spools, as from the scheme on the side*

	A
<b>GMV15</b>	200 (7.874)
<b>Q25 - Q45</b>	280 (11.024)
<b>Q75 - Q95</b>	300 (11.811)

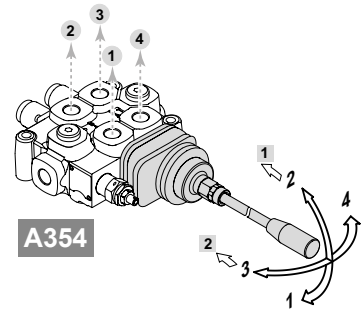
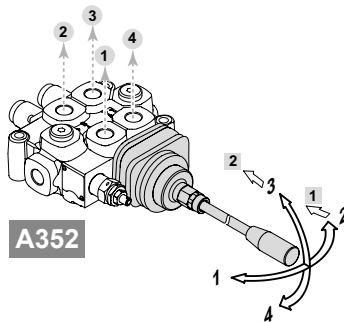
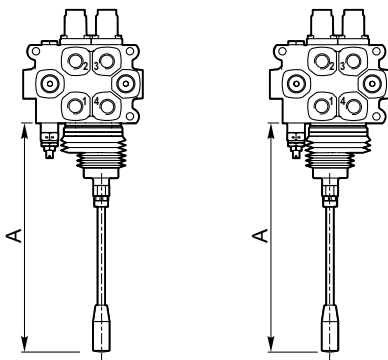
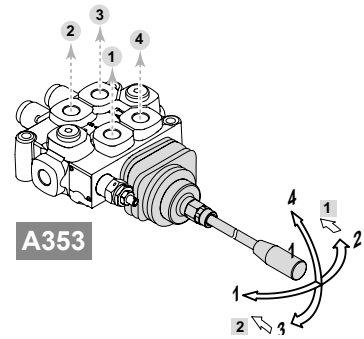
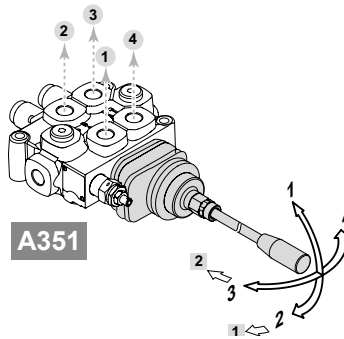
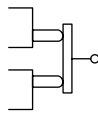

N.B. Nelle configurazioni A351 e A353, la parte inferiore del comando sporge dal piano di appoggio.  
*Note: A351 - A353 configurations the smallest size is lower than the bolster.*

Eventuale cassetto con 4<sup>a</sup> pos. (solo cod.126)  
*Optional spool with 4th position (only code 126)*  
1 su 1<sup>a</sup> sezione / on 1<sup>st</sup> section  
2 su 2<sup>a</sup> sezione / on 2<sup>nd</sup> section

## Sezione di lavoro

## Working section



## A16

Leva a cloche per il controllo singolo o simultaneo di due cursori come schema a lato  
*Dual axis for single or simultaneous control of two spools as from the scheme on the side*

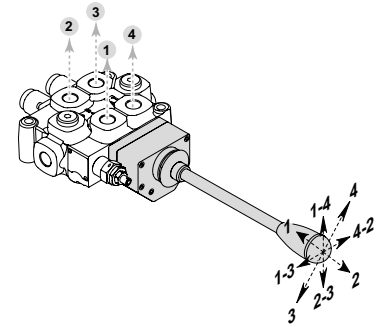
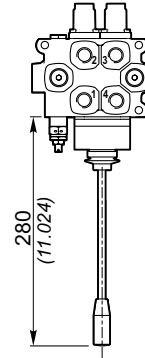
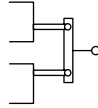

I comandi **A15**, **A16** o **SLA15** sono dei joystick che comandano due sezioni di lavoro; essendo un comando unico viene inserito come codice solo nella prima sezione di lavoro e viene omesso nella seconda.

## Esempio

Q25 – F7SR250 – 103/**A15**/M1 – 103/M1 – F3D

Nella seconda sezione di lavoro è indicato solo il cursore e il posizionatore.

Quando è richiesto anche il cavo C1, è necessario specificarne la lunghezza in entrambe le sezioni.

## Esempio

Q25 – F7SR250 – 103/**A8-C1x1000**-SLA15/M1 – 103/**A8-C1x1000**/M1 – F3D

*Controls **A15**, **A16** or **SLA15** are joysticks that control two working sections. Since it is a single control, it is only entered as a code in the first work section and is omitted from the second.*

## Example

*Q25 – F7SR250 – 103/**A15**/M1 – 103/M1 – F3D*

*Only the spool and positioner are indicated in the second working section.*

*When cable C1 is also required, its length must be specified in both sections.*

## Example

*Q25 – F7SR250 – 103/**A8-C1x1000**-SLA15/M1 – 103/**A8-C1x1000**/M1 – F3D*

Sezione di lavoro

Working section



**N1-A1**  
**N1A-A1**  
**N1B-A1**

Comando manuale con attivazione del contatto elettrico del microswitch centralizzato.

N1-A1: Per doppio effetto

N1A-A1: Per semplice effetto in pos. 1

N1B-A1: Per semplice effetto in pos. 2

*Hand control with ON-OFF centralized microswitch operation.*

*N1 -A1: Double acting*

*N1A-A1: Single acting in 1 position*

*N1B-A1: Single acting in 2 position*

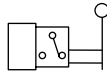

Microswitch non di nostra fornitura  
Microswitch not supplied by Galtech

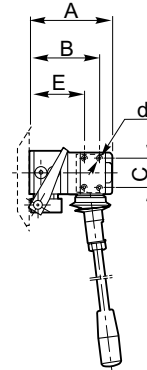
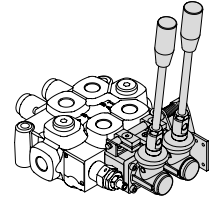
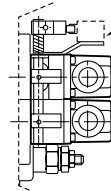

	A	B	C	E	d
<b>Q15 - GMV15</b>	64 (2.520)	42 (1.654)	22.2 (0.874)	31.7 (1.248)	M2.5
<b>Q25 - Q45</b>	70 (2.756)	59	25 (0.984)	49 (1.929)	M4
<b>Q75 - Q95</b>	84 (3.307)	(2.323)			

**N1-A2**  
**N1A-A2**  
**N1B-A2**

Comando manuale ruotato di 180° con attivazione del contatto elettrico del microswitch centralizzato.

N1-A2: Per doppio effetto

N1A-A2: Per semplice effetto in pos. 1

N1B-A2: Per semplice effetto in pos. 2

*180° rotated hand control with ON-OFF centralized microswitch operation.*

*N1-A2: Double acting*

*N1A-A2: Single acting in 1 position*

*N1B-A2: Single acting in 2 position*

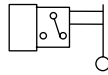

Microswitch non di nostra fornitura  
Microswitch not supplied by Galtech

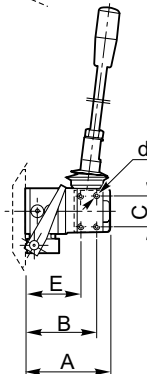
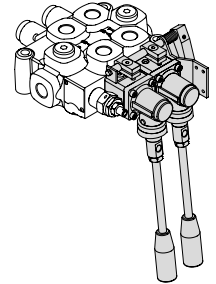
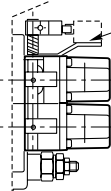

	A	B	C	E	d
<b>Q15 - GMV15</b>	64 (2.520)	42 (1.654)	22.2 (0.874)	31.7 (1.248)	M2.5
<b>Q25 - Q45</b>	70 (2.756)	59	25 (0.984)	49 (1.929)	M4
<b>Q75 - Q95</b>	84 (3.307)	(2.323)			

**N1-A3**  
**N1A-A3**  
**N1B-A3**

Comando microswitch centralizzato.

N1-A3: Per doppio effetto

N1A-A3: Per semplice effetto in pos. 1

N1B-A3: Per semplice effetto in pos. 2

*Centralized microswitch control.*

*N1-A3: Double acting*

*N1A-A3: Single acting in 1 position*

*N1B-A3: Single acting in 2 position*

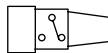

Microswitch non di nostra fornitura  
Microswitch not supplied by Galtech

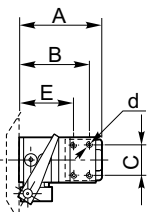
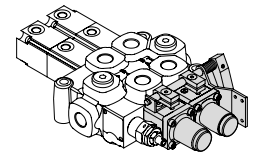
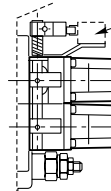

	A	B	C	E	d
<b>Q25 - Q45</b>	70 (2.756)	59	25 (0.984)	49 (1.929)	M4
<b>Q75 - Q95</b>	84 (3.307)	(2.323)			

## Sezione di lavoro

## Working section



## 7 - Tipo posizionario

\* La posizione dei campi 5 e 6 si riferisce al comando collocato sul lato effetto A e al posizionario lato effetto B; se le posizioni sono opposte, invertire i due campi 5 e 6 come da esempio seguente:

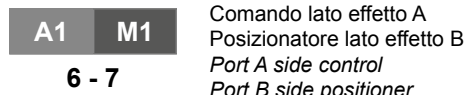

## 6 - Positioner type

\* The position of fields 5 and 6 refers to the control located on the A port side and to the positioner on the B port side. If the positions are opposite, invert the two fields 5 and 6 as shown in the example below:

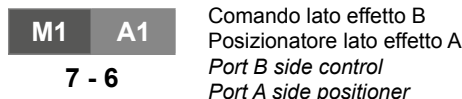

## Posizionatori / Positioner

Q35	Q15	GMV 15	Q25	Q45	Q65	Q75	Q95
-----	-----	-----------	-----	-----	-----	-----	-----

M1	Tre posizioni ritorno a molla in pos.0	Three positions spring centred in 0	•	•	•	•	•
M2	Due posizioni 0-1 ritorno a molla in pos.0	Two positions spring 0-1 centred in 0		•	•	•	•
M3	Due posizioni 0-2 ritorno a molla in pos.0	Two positions spring 0-2 centred in 0		•	•	•	•
M4(1-2)	Due posizioni estreme ritorno a molla in pos.1	Two end positions spring back in 1	•		•	•	•
M4(2-1)	Due posizioni estreme ritorno a molla in pos.2	Two end positions spring back in 2	•		•	•	•
R0	Posizionamento frizionato	Friction positioner	•		•	•	•
R1	Tre posizioni ritorno a molla in pos.0, detent in pos.1	Three positions spring centred in 0, detent in 1	•		•	•	•
R2	Tre posizioni ritorno a molla in pos.0, detent in pos.2	Three positions spring centred in 0, detent in 2	•		•	•	•
R3	Tre posizioni in detent	Three positions detent	•	•	•	•	•
R4	Due posizioni in detent 0-1	Two positions detent 0-1		•	•	•	•
R5	Due posizioni in detent 0-2	Two positions detent 0-2		•	•	•	•
R6	Due posizioni in detent 1-2	Two positions detent 1-2			•	•	•
R8*	Due posizioni (1 e 2) con ritorno a molla in pos. 0; (3) 4ª posizione flottante con detent. (Da montare con Z1 lato comando e cursore 116)	Two positions (1 and 2) with spring return centred in 0 position. (3) 4th position floating with detent. (Mounting with Z1 side control and spool 116)		•		•	•
R10/Z1*	Due posizioni (1 e 2) con ritorno a molla in pos. 0, (3) 4ª posizione flottante con detent (da montare con cursore 126)	Two positions (1 and 2) with spring return centred in 0, position (3) 4th position floating with detent (mounting with spool 126)		•	•		•
R1K*	Comando a 3 posizioni, detent in pos. 1 con sgancio automatico registrabile. Disponibile solo con cursore cod. 103 e 111	3 Position control, detent in 1 pos. with automatic adjustable release. Available with spool code 103 and 111 only			•	•	•
R2K*	Comando a 3 posizioni, detent in pos. 2 con sgancio automatico registrabile. Disponibile solo con cursore cod. 103 e 111	3 Position control, detent in 2 pos. with automatic adjustable release. Available with spool code 103 and 111 only			•	•	•
R3K*	Comando a 3 posizioni, detent in pos. 1 e 2 con sgancio automatico registrabile. Disponibile solo con cursore cod. 103 e 111	3 Position control, detent in 1 and 2 pos. with automatic adjustable release. Available with spool code 103 and 111 only			•	•	•
M1-B1	Tre posizioni ritorno a molla in pos.0 con comando microswitch posteriore	Three positions spring centred in 0 with back microswitch control			•	•	•
M2-B1	Due posizioni, 0-1, ritorno a molla in pos.0 con comando microswitch posteriore	Two positions 0-1, spring centred in 0 with back microswitch control			•	•	•
M3-B1	Due posizioni, 0-2, ritorno a molla in pos. 0 con comando microswitch posteriore	Two positions 0-2, spring centred in 0 with back microswitch control			•	•	•
M1-N1 M1-N1A M1-N1B	Tre posizioni ritorno a molla in pos. 0, con attivazione del contatto elettrico del microswitch centralizzato <b>M1-N1:</b> Per doppio effetto <b>M1-N1A:</b> Per semplice effetto in pos 1 <b>M1-N1B:</b> Per semplice effetto in pos 2	Three positions spring centred in 0, with ON-OFF centralized microswitch operation. N1-A1: Double acting N1A-A1: Single acting in 1 position N1B-A1: Single acting in 2 position			•	•	•
M2-N1	Due posizioni, 0-1, con ritorno a molla in pos.0, con attivazione del contatto elettrico del microswitch centralizzato	Two positions, 0-1, with spring centred in 0, with ON-OFF centralized microswitch operation			•	•	•
M3-N1	Due posizioni, 0-2, con ritorno a molla in pos.0, con attivazione del contatto elettrico del microswitch centralizzato	Two positions, 0-2, with spring centred in 0, with ON-OFF centralized microswitch operation			•	•	•
M1-B4	Posizionamento con micro a tenuta stagna	Positioning with watertight	•		•	•	

## \* Limitazioni / Limitations

Posizionario Positioner	Applicabile con: / Applicable with:	
	Comando / Control	Cursore / Spool
<b>R8</b>	A1/Z1 - A2/Z1 - A4/Z1 - A6/Z1 - A8/Z1	116
<b>R10/Z1</b>	Tutti / All	126
<b>R1K R2K R3K</b>	A1 / A2 / A4 / A5 / A6 / A8 / SL / SLA15 / A15 / A16 / N1-A1 / N1-A2 / N1-A3	103 / 111

Sezione di lavoro

Working section

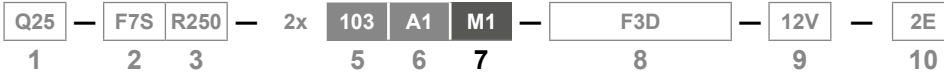

**M1**

Tre posizioni ritorno a molla in pos.0  
Three positions spring centred in 0



**M2**

Due posizioni 0-1 ritorno a molla in pos.0  
Two positions spring 0-1 centred in 0

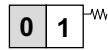

**M3**

Due posizioni 0-2 ritorno a molla in pos.0  
Two positions spring 0-2 centred in 0



**M4 (1-2)**

Due posizioni estreme ritorno a molla in pos.1  
Two end positions spring back in 1

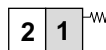

**M4 (2-1)**

Due posizioni estreme ritorno a molla in pos.2  
Two end positions spring back in 2

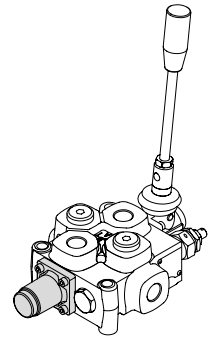
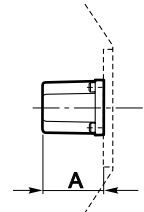
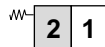

	A			
	M1	M2	M3	M4 2-1
Q15	22.5	22.5	22.5	
GMV15	(0.886)	(0.886)	(0.886)	
Q35	42	42	42	42
Q25 - Q45	(1.654)	(1.654)	(1.654)	(1.654)
Q65	55	55	55	55
Q75 - Q95	(2.165)	(2.165)	(2.165)	(2.165)

**R0**

Posizionamento frizionato  
Friction positioner

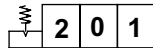

Q35 - Q25 - Q45

Frizione non registrabile  
Not adjustable friction

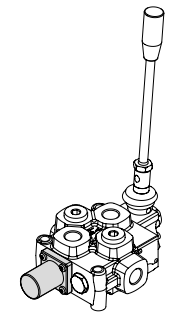
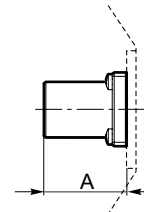

	A
Q25 - Q35 - Q45	42 (1.654)

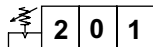

Q65 - Q75 - Q95

Frizione registrabile  
Adjustable friction

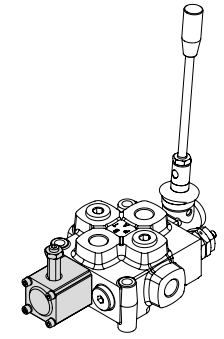
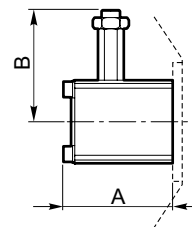

	A	B
Q65 - Q75 - Q95	59 (2.323)	60 (2.362)

Sezione di lavoro

Working section



R1

Tre posizioni ritorno a molla in pos.0, detent in pos.1  
 Three positions spring centred in 0, detent in 1

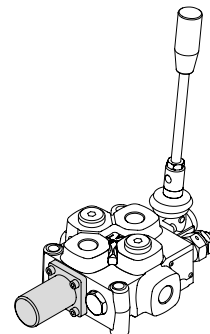
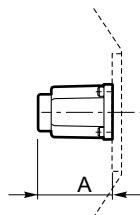

R2

Tre posizioni ritorno a molla in pos.0, detent in pos.2  
 Three positions spring centred in 0, detent in 2



	A	
	R1	R2
Q35	52	54
Q25 - Q45	(2.047)	(2.126)
Q65	70	68.5
Q75 - Q95	(2.756)	(2.697)

R3

Tre posizioni in detent  
 Three positions detent

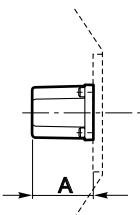
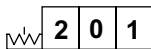

R4

Due posizioni in detent 0-1  
 Two positions detent 0-1

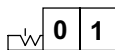

R5

Due posizioni in detent 0-2  
 Two positions detent 0-2

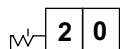

	A			
	R3	R4	R5	R6
Q15	22	22	22	
GMV15	(0.866)	(0.866)	(0.866)	
Q35	42	42	42	42
Q25 - Q45	(1.654)	(1.654)	(1.654)	(1.654)
Q65	55	55	55	55
Q75 - Q95	(2.165)	(2.165)	(2.165)	(2.165)

R6

Due posizioni in detent 1-2  
 Two positions detent 1-2

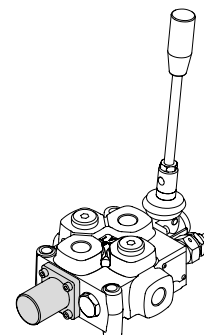
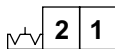



Sezione di lavoro

Working section



R8

Due posizioni (1 e 2) con ritorno a molla in pos. 0; (3) 4ª posizione flottante con detent.  
 (Da montare con Z1 lato comando e cursore 116)  
*Two positions (1 and 2) with spring return centred in 0 position.  
 (3) 4th position floating with detent.  
 (Mounting with Z1 side control and spool 116)*

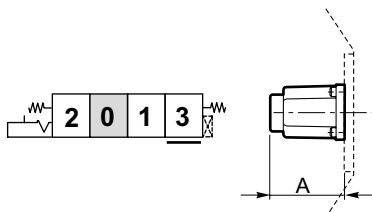

	A
Q15	43
GMV15	(1.693)
Q25 - Q45	56.5
	(2.224)
Q65	75
Q75 - Q95	(2.953)

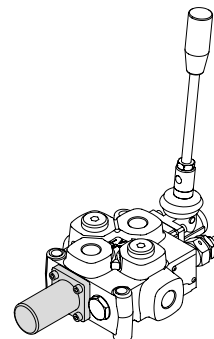

R10/Z1

Due posizioni (1 e 2) con ritorno a molla in pos. 0, (3) 4ª posizione flottante con detent  
 (Da montare cursore 126)  
*Two positions (1 and 2) with spring return centred in 0 position  
 (3) 4th position floating with detent.  
 (Mounting with spool 126)*

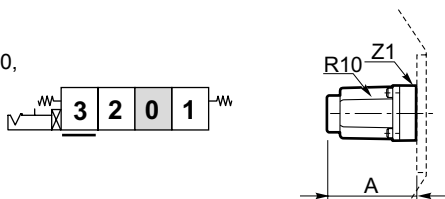

	A
Q15	50
GMV15	(1.969)
Q25 - Q45	70
	(2.756)
Q75 - Q95	92
	(3.622)

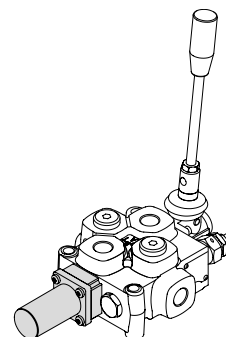

R1K

Comando a 3 posizioni, detent in pos. 1 con sgancio automatico registrabile. Disponibile solo con cursore cod. 103 e 111  
*3 Position control, detent in 1 pos. with automatic adjustable release. Available with spool code 103 and 111 only*

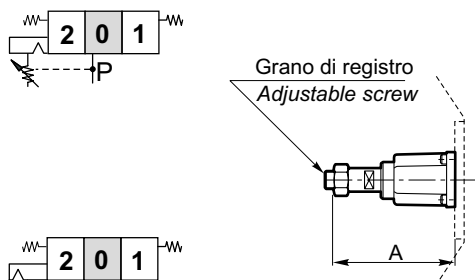

R2K

Comando a 3 posizioni, detent in pos. 2 con sgancio automatico registrabile. Disponibile solo con cursore cod. 103 e 111  
*3 Position control, detent in 2 pos. with automatic adjustable release. Available with spool code 103 and 111 only*

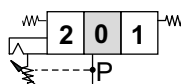

R3K

Comando a 3 posizioni, detent in pos. 1 e 2 con sgancio automatico registrabile. Disponibile solo con cursore cod. 103 e 111  
*3 Position control, detent in 1 and 2 pos. with automatic adjustable release. Available with spool code 103 and 111 only*

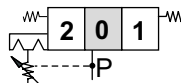

	A		
	R1K	R2K	R3K
Q25 - Q45	91.5	91.5	91.5
	(3.602)	(3.602)	(3.602)
Q75 - Q95	106	106	106
	(4.173)	(4.173)	(4.173)

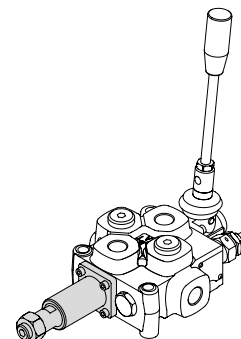

Campo di taratura della pressione per lo sgancio automatico 45 - 350 bar (653 - 5075 PSI)  
 Pressure calibration field for automatic release 45 - 350 bar (653 - 5075 PSI)

Sezione di lavoro

Working section

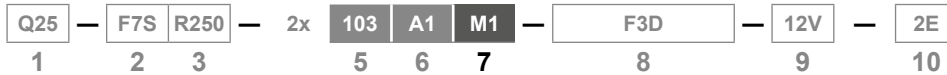

M1-B1

Tre posizioni ritorno a molla in pos.0 con comando microswitch posteriore  
 Three positions spring centred in 0 with back microswitch control

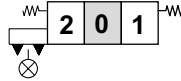

Microswitch non di nostra fornitura

Microswitch not supplied by Galtech

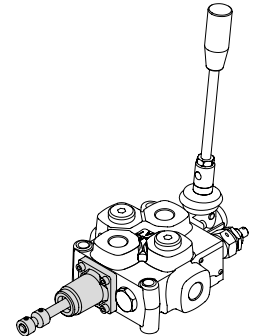
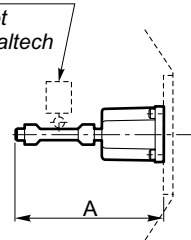

M2-B1

Due posizioni, 0-1, ritorno a molla in pos.0 con comando microswitch posteriore  
 Two positions, 0-1, spring centred in 0 with back microswitch control

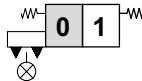

	A		
	M1-B1	M2-B1	M3-B1
Q25 - Q45	82 (3.228)	82 (3.228)	82 (3.228)
Q75 - Q95	102 (4.016)	102 (4.016)	102 (4.016)

M3-B1

Due posizioni, 0-2, ritorno a molla in pos. 0 con comando microswitch posteriore  
 Two positions, 0-2, spring centred in 0 with back microswitch control

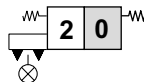

M1-N1  
 M1-N1A  
 M1-N1B

Tre posizioni ritorno a molla in pos. 0, con attivazione del contatto elettrico del microswitch centralizzato  
 M1-N1: Per doppio effetto  
 M1-N1A: Per semplice effetto in pos 1  
 M1-N1B: Per semplice effetto in pos 2  
 Three positions spring centred in 0, with ON-OFF centralized microswitch operation.  
 N1-A1: Double acting  
 N1A-A1: Single acting in 1 position  
 N1B-A1: Single acting in 2 position

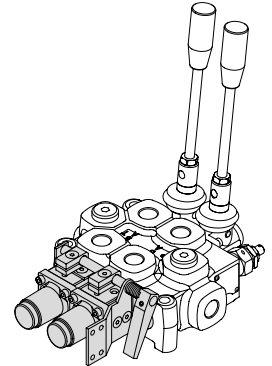
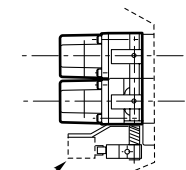
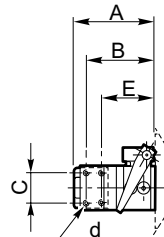
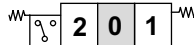

M2-N1

Due posizioni, 0-1, con ritorno a molla in pos.0, con attivazione del contatto elettrico del microswitch centralizzato  
 Two positions, 0-1, with spring centred in 0, with ON-OFF centralized microswitch operation



Microswitch non di nostra fornitura  
 Microswitch not supplied by Galtech

M3-N1

Due posizioni, 0-2, con ritorno a molla in pos.0, con attivazione del contatto elettrico del microswitch centralizzato  
 Two positions, 0-2, with spring centred in 0, with ON-OFF centralized microswitch operation

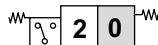

	A	B	C	E	d
Q25 - Q45	70 (2.756)	59	25 (0.984)	49 (1.929)	M4
Q75 - Q95	84 (3.307)				

## Sezione di lavoro

## Working section



## M1-B4

Posizionatore con micro a tenuta stagna.  
Positioning with watertight microswitch.

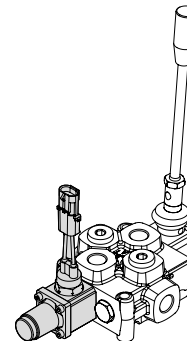
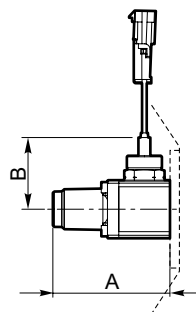
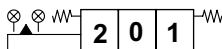

	A	B
Q25 - Q45	75.5 (2.972)	50 (1.969)

## Caratteristiche elettriche / Electrical Characteristic

Corrente / Current	0.01 ÷ 5.0	Amp
Tensione / Voltage	5 ÷ 24	VDC
Connettore / Connector	Packard weather pack	
Temperatura / Temperature	-40 ÷ 120	°C
Tipo / Type	Normalmente aperto <i>Normally open</i>	

## Sezione di lavoro

## Working section



## Comandi con posizionamento / Controls with positioning

		Q35	Q25	Q45	Q75	Q95
M1-U1*	Tre posizioni con ritorno a molla in pos.0, attacco diretto sul cursore per rinvio a distanza rigido		•	•	•	•
M2-U1*	Due posizioni, 0-1, con ritorno a molla in pos.0, attacco diretto sul cursore per rinvio a distanza rigido		•	•	•	•
M3-U1*	Due posizioni, 0-2, con ritorno a molla in pos. 0, attacco diretto sul cursore per rinvio a distanza rigido		•	•	•	•
M1-U2*	Tre posizioni con ritorno a molla in pos. 0, attacco diretto sul cursore per rinvio a distanza con cavo flessibile		•	•	•	•
M2-U2*	Due posizioni, 0-1, ritorno a molla in pos. 0, attacco diretto sul cursore per rinvio a distanza con cavo flessibile		•	•	•	•
M3-U2*	Due posizioni, 0-2, ritorno a molla in pos. 0, attacco diretto sul cursore per rinvio a distanza con cavo flessibile		•	•	•	•
D2*	Comando elettroidraulico doppio con ritorno in pos. 0				•	•
P1-N*	Comando pneumatico		•	•	•	•
P1-NP*	Comando pneumatico progressivo		•	•	•	•
D3*	Comando elettropneumatico		•	•	•	•

## \* Limitazioni / Limitations

Posizionatore Positioner	Applicabile con: / Applicable with:	
	Comando / Control	Cursore / Spool
M1-U1 M2-U1 M3-U1 M1-U2 M2-U2 M3-U2 D2 P1-N P1-NP D3	A1 / A2 / A3 / A4 / A6 / A8	Tutti tranne 116 e 126 All except 116 and 126

Sezione di lavoro

Working section

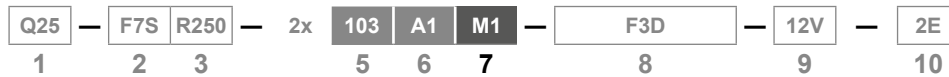

**M1-U1**

Tre posizioni con ritorno a molla in pos.0, attacco diretto sul cursore per rinvio a distanza rigido  
*Three positions spring centred in 0, with direct control connection on spool, cap side, for stiff remote control*

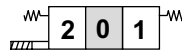

**M2-U1**

Due posizioni, 0-1, con ritorno a molla in pos.0, attacco diretto sul cursore per rinvio a distanza rigido  
*Two positions, 0-1, spring centred in 0, with direct control connection on spool, cap side, for stiff remote control*

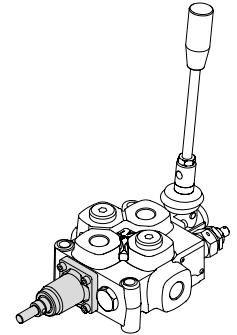
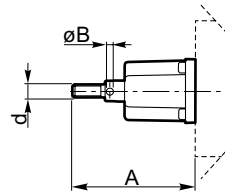
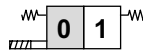

**M3-U1**

Due posizioni, 0-2, con ritorno a molla in pos. 0, attacco diretto sul cursore per rinvio a distanza rigido  
*Two positions, 0-2, spring centred in 0, with direct control connection on spool, cap side, for stiff remote control*

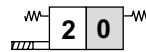

	A	B	d
Q25 - Q45	73 (2.874)	4 (0.157)	M8
Q75 - Q95	96 (3.780)	5 (0.197)	M10

**M1-U2**

Tre posizioni con ritorno a molla in pos. 0, attacco diretto sul cursore per rinvio a distanza con cavo flessibile  
*Three positions spring centred in 0, direct control connection on spool, cap side, for flexible remote control*



**M2-U2**

Due posizioni, 0-1, ritorno a molla in pos. 0, attacco diretto sul cursore per rinvio a distanza con cavo flessibile  
*Two positions, 0-1, spring centred in 0, direct control connection on spool, cap side, for flexible remote control*

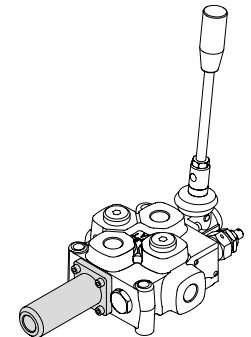
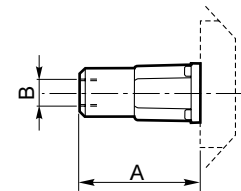
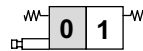

**M3-U2**

Due posizioni, 0-2, ritorno a molla in pos. 0, attacco diretto sul cursore per rinvio a distanza con cavo flessibile  
*Two positions, 0-2, spring centred in 0, direct control connection on spool, cap side, for flexible remote control*



	A	B
Q25 - Q45	73 (2.874)	M16X1.5
Q75 - Q95	77 (3.031)	

Sezione di lavoro

Working section

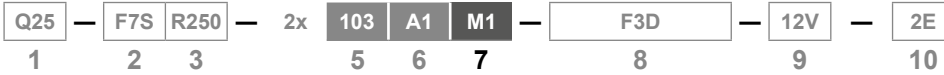

D2

Solo per Q75 e Q95  
Only for Q75 and Q95

Comando elettroidraulico doppio  
con ritorno in pos. 0  
Double electro-hydraulic  
control spring centred in 0

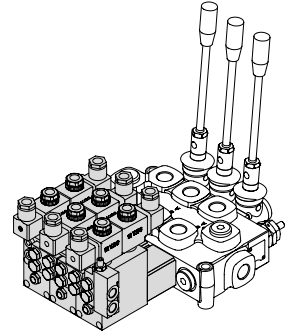
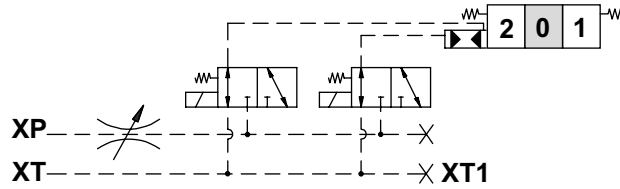

Vite di regolazione  
velocità di commutazione  
Commutation speed  
adjusting screw

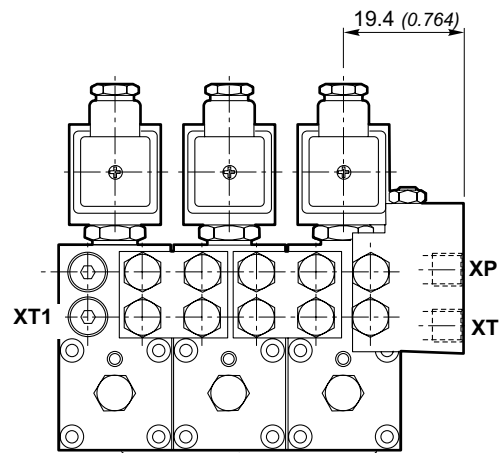
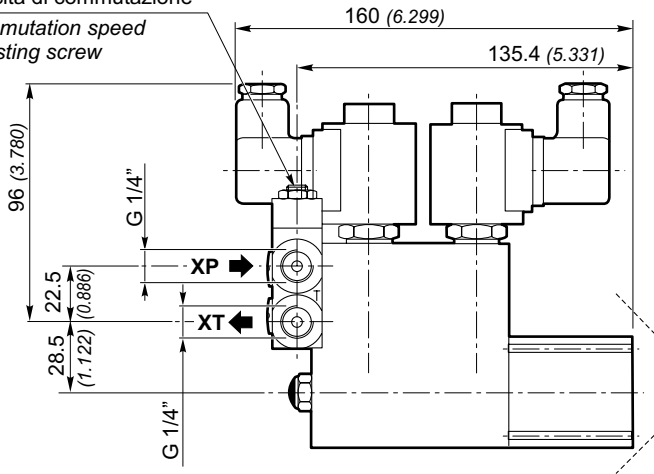

Codice: D2-2R per elementi successivi  
Code: D2-2R for the following elements

Codice: D2-1R per il 1° elemento  
Code: D2-1R for the 1° elements

Pressione di pilotaggio in XP Pilot pressure in XP		Contropressione max. su XT Maximum back pressure on XT	Portata minima per ogni elemento Minimum flow for each section	Volume di pilotaggio per elemento Piloting volume for each section
Max.	Min.	4 bar (56 PSI)	0.5 lt/min (0.132 GPM)	5.5 cm <sup>3</sup> (0.336 in <sup>3</sup> )
35 bar (490 PSI)	20 bar (280 PSI)			

Caratteristiche tecniche elettromagnete tipo "H" / Electromagnet characteristics type "H"

Attacco magnete / Magnet connection	Tipo DIN 43650 (versione A) / Type DIN 43650 (A version)
Tipo di protezione / Protection type	IP 65
Classe d'isolamento / Coil insulation class	H 180 VDE 0580
Tensione di alimentazione / Supply voltage	D.C.: 12, 24V A.C. - 50 Hz: 110, 220 V
Variazione di tensione max. / Maximum voltage tolerance	± 10%
Potenza assorbita / Absorbed power supply	18 W
Rapporto di max. utilizzo / Maximum utilization ratio	100%
Temperatura max. / Max. temperature	100° C

Sezione di lavoro

Working section

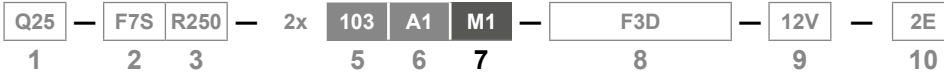

P1-N

Comando pneumatico a tre posizioni con ritorno in pos. 0  
 Three positions pneumatic control, spring centred in 0

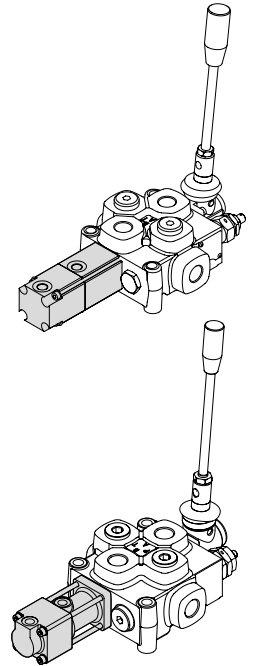
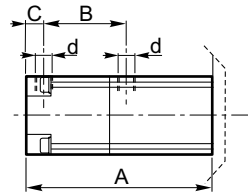

Q25-Q45 Supporto del comando in Alluminio  
 Q25-Q45 Command support in aluminium  
 Q75-Q95 Supporto del comando in Tecnopolimero  
 Q75-Q95 Command support in technopolimer

	A	B	C	d
Q25 - Q45	90.5 (3.563)	43 (1.693)	10 (0.394)	G 1/8"
Q75 - Q95	107 (4.213)	48 (1.890)	10.5 (0.413)	

Pressione di pilotaggio / Pilot pressure	Min.	5 bar (72.5 PSI)
	Max.	30 bar (435 PSI)
Volume pilotaggio / Pilot volume	Q25-Q45	4 cm <sup>3</sup> (0.244 in <sup>3</sup> )
	Q75-Q95	9 cm <sup>3</sup> (0.549 in <sup>3</sup> )

P1-NP

Comando pneumatico progressivo a tre posizioni con ritorno in posizione 0 per azionamento con manipolatore  
 Three positions progressive pneumatic control, spring centred in 0 for remote control

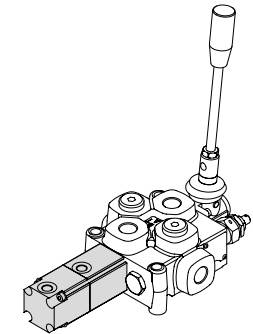
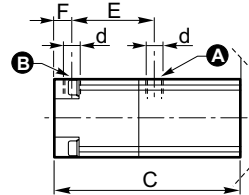

Q25-Q45 Supporto del comando in Alluminio  
 Q25-Q45 Command support in aluminium  
 Q75-Q95 Supporto del comando in Tecnopolimero  
 Q75-Q95 Command support in technopolimer

	C	E	F	d
Q25 - Q45	90.5 (3.563)	43 (1.693)	10 (0.394)	G 1/8"
Q75 - Q95	107 (4.213)	48 (1.890)	10.5 (0.413)	

Diagramma pressione di pilotaggio - Corsa spool / Pilot pressure diagram - Spool stroke

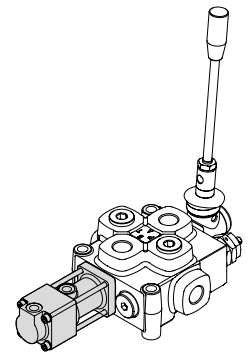
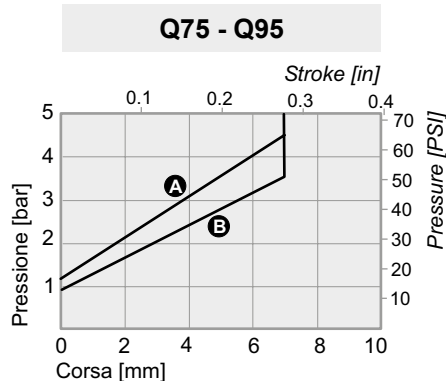
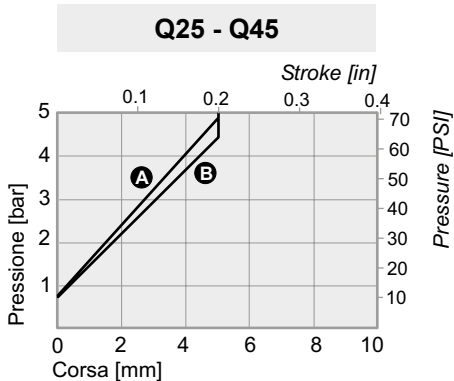

Pressione di pilotaggio / Pilot pressure	Min.	5 bar (72.5 PSI)
	Max.	30 bar (435 PSI)
Volume pilotaggio / Pilot volume	Q25-Q45	4 cm <sup>3</sup> (0.244 in <sup>3</sup> )
	Q75-Q95	9 cm <sup>3</sup> (0.549 in <sup>3</sup> )

Sezione di lavoro

Working section

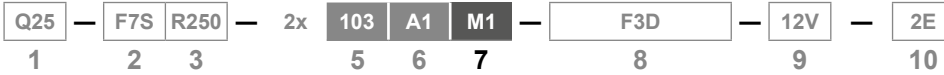

D3

Comando elettropneumatico a tre posizioni con ritorno in pos. 0  
 Three positions electro-pneumatic control, spring centred in 0

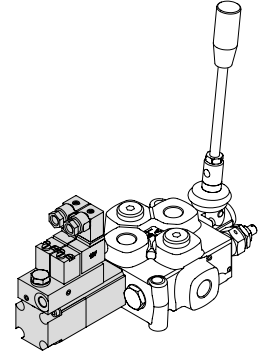
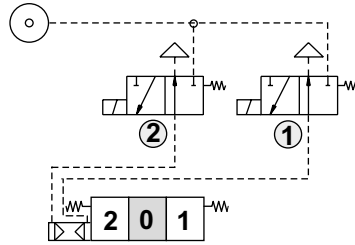

Q25-Q45 Supporto del comando in Alluminio  
 Q25-Q45 Command support in aluminium

Q25 - Q45

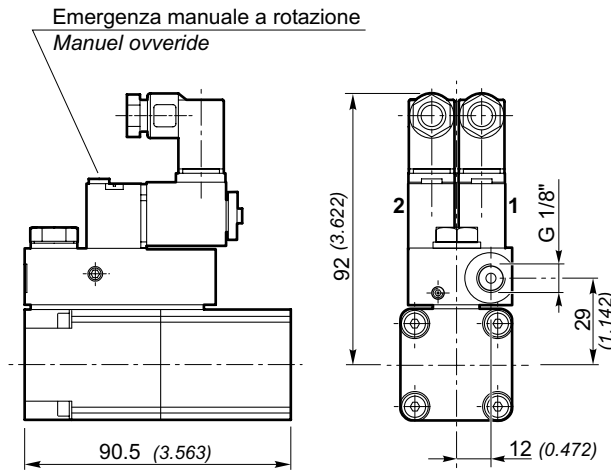

Caratteristiche di funzionamento Operation characteristics	
Pressione di pilotaggio Pilot pressure	1 ÷ 10 bar (14.5 ÷ 145 PSI)
Volume pilotaggio Pilot volume	27NI/ a 6 bar Δpl (27NI/ a 87 PSI Δpl)

Caratteristiche tecniche elettromagnete Electromagnet characteristics	
Tipo attacco magnete Magnet connection type	DIN 175301-803-C
Tipo di protezione Protection type	IP 65
Classe d'isolamento Coil insulation class	F
Tensione di alimentazione Supply voltage	D.C.: 12, 24V A.C.: 50 Hz 230 V
Variazione di tensione max. Maximum voltage tolerance	± 10%
Potenza assorbita Absorbed power supply	D.C.: 2.9 W A.C. 4VA
Rapporto di max. utilizzo Maximum utilization ratio	100%
Temperatura max. Max. temperature	-10 ÷ 50 °C

Q75-Q95 Supporto del comando in Tecnopolimero  
 Q75-Q95 Command support in technopolimer

Q75 - Q95

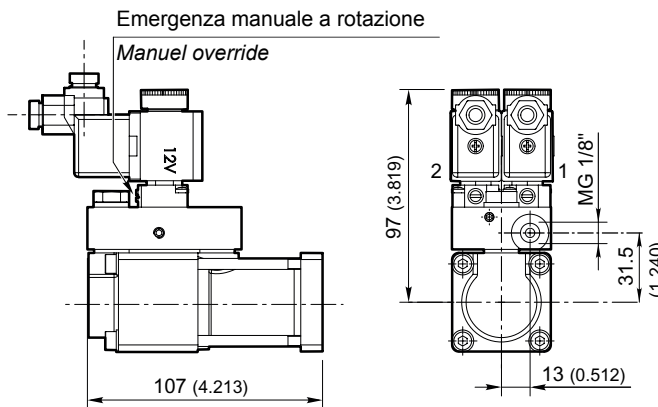

Caratteristiche di funzionamento Operation characteristics	
Pressione di pilotaggio Pilot pressure	1 ÷ 10 bar (14.5 ÷ 145 PSI)
Volume pilotaggio Pilot volume	53NI/ a 6 bar Δpl (53NI/ a 87 PSI Δpl)

Caratteristiche tecniche elettromagnete Electromagnet characteristics	
Tipo attacco magnete Magnet connection type	DIN 43650
Tipo di protezione Protection type	IP 65
Classe d'isolamento Coil insulation class	F
Tensione di alimentazione Supply voltage	D.C.: 12, 24V
Variazione di tensione max. Maximum voltage tolerance	± 10%
Potenza assorbita Absorbed power supply	D.C.: 5 W
Rapporto di max. utilizzo Maximum utilization ratio	100%
Temperatura max. Max. temperature	-10 ÷ 50 °C



## Sezione di lavoro

## Working section

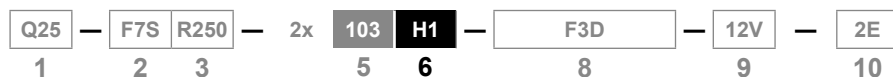

## Comandi completi / Complete controls

			Q15 GMV15	Q25	Q45	Q75	Q95
H1*	Comando idraulico ad alta pressione ON-OFF a tre posizioni, ritorno a molla in posizione 0	Three positions with high-pressure hydraulic control, spring centered in 0 position		•	•	•	•
H5*	Comando idraulico a bassa pressione per manipolatore idraulico	Low pressure hydraulic control for hydraulic pilot valves		•	•	•	•
RTL-s*	Comando rotativo frizionato a tre posizioni: tacca in pos. 0, leva in pos. 2	3-position clutch-operated rotary control: notch mark in pos. 0, lever in pos. 2		•	•	•	•
RTL-d*	Comando rotativo frizionato a tre posizioni: tacca in pos. 0, leva in pos. 1	3-position clutch-operated rotary control: detent in pos. 0, lever in pos. 1		•	•	•	•
C2*	Comando a camme 2 posizioni estreme 1-2, ritorno a molla in pos. 1	Cam control, 2 end positions 1-2, spring centered in 1 position		•	•	•	•
C3*	Comando a camme 2 posizioni estreme 2-1, ritorno a molla in pos. 2	Cam control, 2 end positions 2-1, spring centered in 2 position		•	•	•	•
A1/D41*	Comando elettrico diretto doppio, ritorno a molla in pos. 0	Double direct electrical control with spring centered in 0	•	•	•	•	•
A2/D41*	Comando elettrico diretto doppio con leva ruotata, ritorno a molla in pos. 0	180° rotated double direct electrical control with spring centred in 0	•	•	•	•	•
A1/DP*	Comando elettrico diretto doppio, ritorno a molla in pos. 0	Double direct electrical control with spring centred in 0		•	•	•	•
A2/DP*	Comando elettrico diretto doppio, ritorno a molla in pos. 0	Double direct electrical control with spring centred in 0		•	•	•	•
D9*	Comando elettrico diretto a due magneti con ritorno a molla in pos. 0	Double direct electrical control with spring centred in 0		•	•	•	•

## \* Limitazioni / Limitations

Comando completo Complete control	Applicabile con: / Applicable with:
	Cursore / Spool
H1	Tutti tranne / All except 116 / 126
H5	
RTL-s	
RTL-d	
C2	
C3	101 / 102 / 103 / 107 / 108 / 109 / 110 / 111
A1/D41	
A2/D41	
A1/DP	
A2/DP	
D9	

Sezione di lavoro

Working section

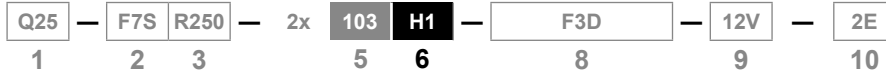

H1

Comando idraulico ad alta pressione ON-OFF a tre posizioni, ritorno a molla in posizione 0  
 Three positions whit high-pressure hydraulic control, spring centred in 0 position

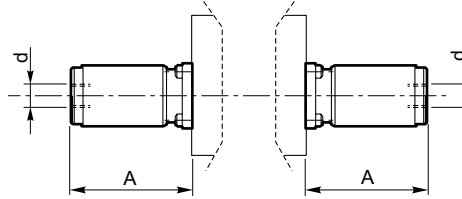
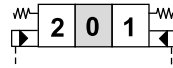

	A	d
Q25 - Q45	70 (2.756)	G 1/4
Q75 - Q95	85 (3.346)	

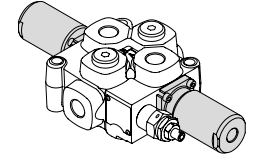

Pressione di pilotaggio / Pilot pressure	Min.	16 bar (232 PSI)
	Max.	350 bar (5075 PSI)
Volume pilotaggio / Pilot volume	Q25-Q45	2 cm <sup>3</sup> (0.122 in <sup>3</sup> )
	Q75-Q95	3 cm <sup>3</sup> (0.183 in <sup>3</sup> )

H5

Comando idraulico a bassa pressione a tre posizioni per manipolatore idraulico, ritorno a molla in posizione 0  
 Three positions whit low-pressure hydraulic control for hydraulic remote control, spring centred in 0 position

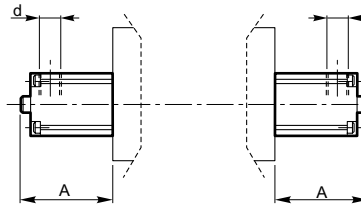
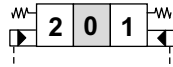

	A	d
Q25 - Q45	50 (1.969)	G 1/4
Q75 - Q95	71.5 (2.815)	



Diagramma pressione di pilotaggio - Corsa spool / Pilot pressure diagram - Spool stroke

Q25 - Q45

Q75 - Q95

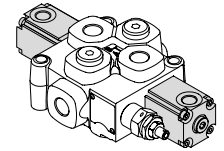
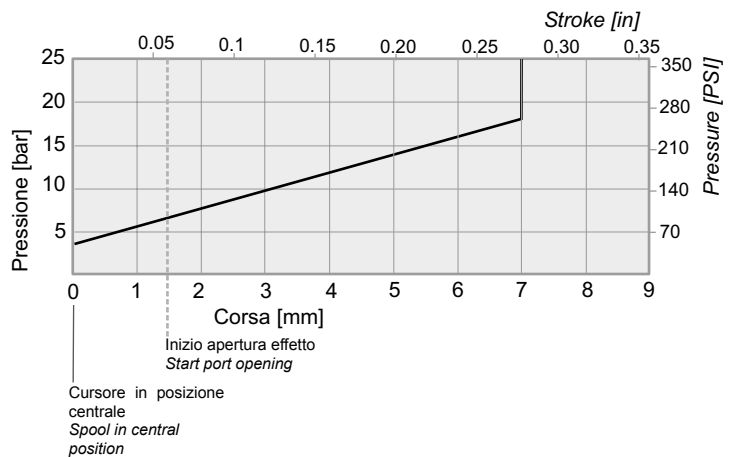
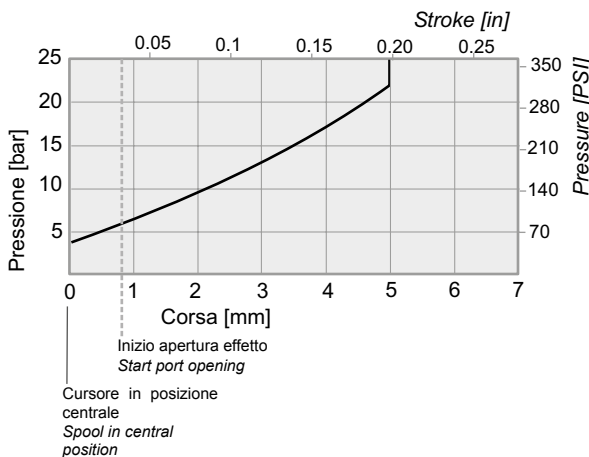

Pressione di pilotaggio / Pilot pressure	Max.	100 bar (1450 PSI)
Volume pilotaggio / Pilot volume	Q25-Q45	1 cm <sup>3</sup> (0.061 in <sup>3</sup> )
	Q75-Q95	2 cm <sup>3</sup> (0.122 in <sup>3</sup> )

N.B.  
 Le curve sono ricavate con cursore 103  
 NOTE. The curves are formed with spool 103 type

Sezione di lavoro

Working section

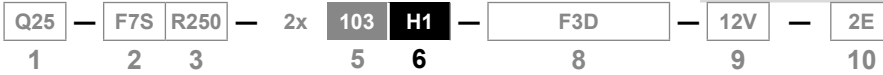

RTL-s

Tre posizioni con comando rotativo frizionato, tacca in pos. 0, leva in pos. 2  
 Three positions with rotary control, lever in 2 position

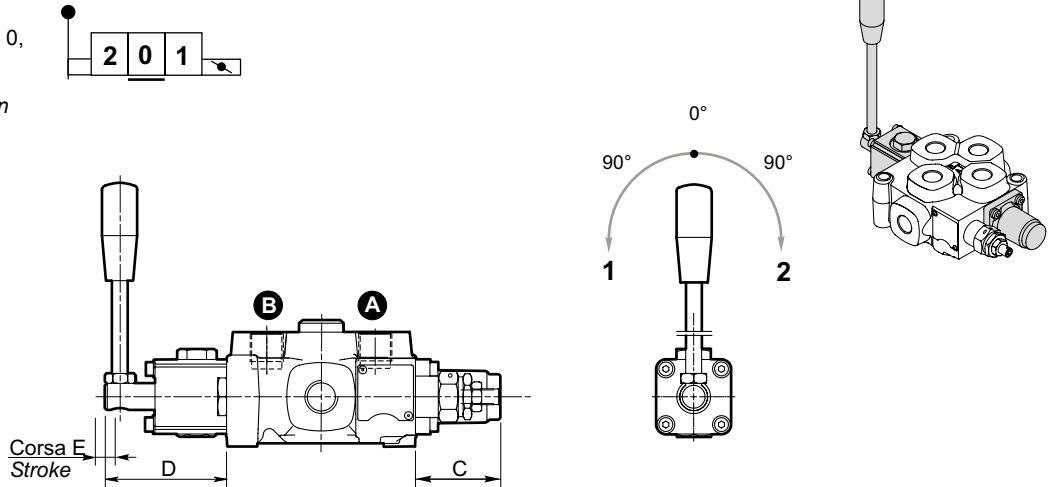

	C	D	E
Q25 - Q45	42 (1.654)	61 (2.402)	10 (5+5) 0.394 (0.197+0.197)
Q75 - Q95	55 (2.165)	72.5 (2.854)	14 (7+7) 0.551 (0.276+ 0.276)

RTL-d

Tre posizioni con comando rotativo frizionato, tacca in pos. 0, leva in pos. 1  
 Three positions with rotary control, lever in 1 position

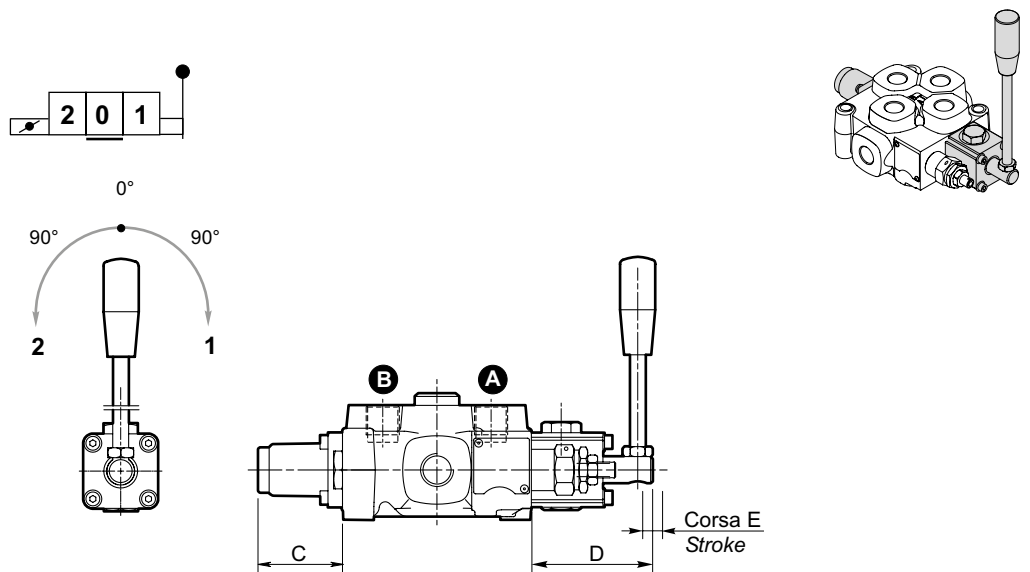

	C	D	E
Q25 - Q45	42 (1.654)	61 (2.402)	10 (5+5) 0.394 (0.197+0.197)
Q75 - Q95	55 (2.165)	72.5 (2.854)	14 (7+7) 0.551 (0.276+ 0.276)

Sezione di lavoro

Working section

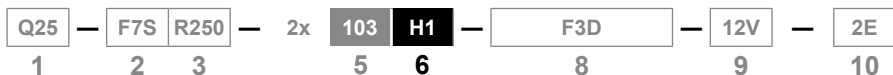

C2

Comando a camme 2 posizioni estreme 1-2, con ritorno a molla in pos. 1  
 Cam control, 2 end positions 1-2, spring centred in 1 position

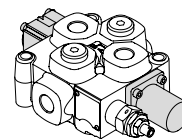
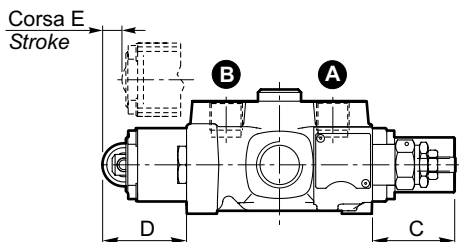
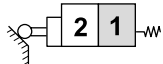

	C	D	E
Q25 - Q45	42 (1.654)	43 (1.693)	10 (0.394)
Q75 - Q95	55 (2.165)	51 (2.008)	14 (0.551)

C3

Comando a camme, 2 posizioni estreme 2-1, con ritorno a molla in pos. 2  
 Cam control, 2 end positions 2-1, spring centred in 2 position

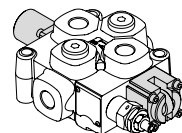
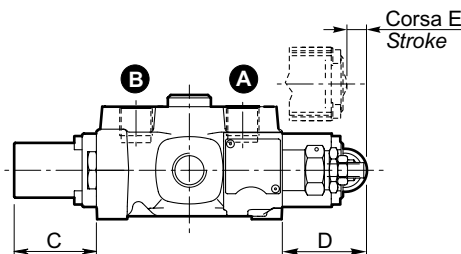
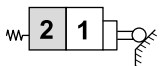

	C	D	E
Q25 - Q45	42 (1.654)	43 (1.693)	10 (0.394)
Q75 - Q95	55 (2.165)	51 (2.008)	14 (0.551)

Sezione di lavoro

Working section

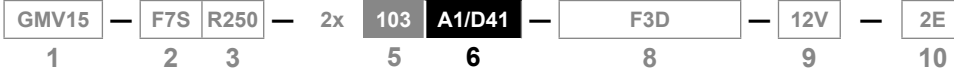

**A1/D41**

Comando elettrico diretto doppio ON/OFF con ritorno a molla in posizione 0  
 ON/OFF double direct electrical control with spring centred in 0

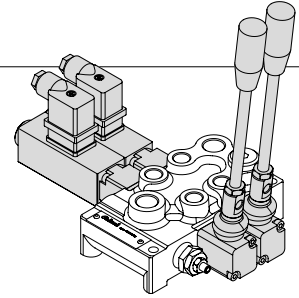
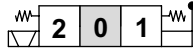

**A2/D41**

Comando elettrico diretto doppio ON/OFF ruotato di 180° con ritorno a molla in posizione 0  
 180° rotated ON/OFF double direct electrical control with spring centred in 0

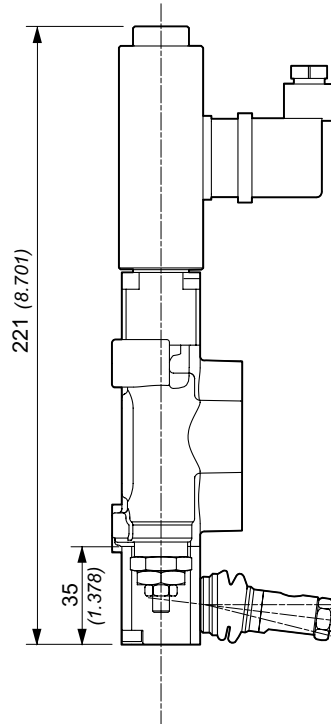
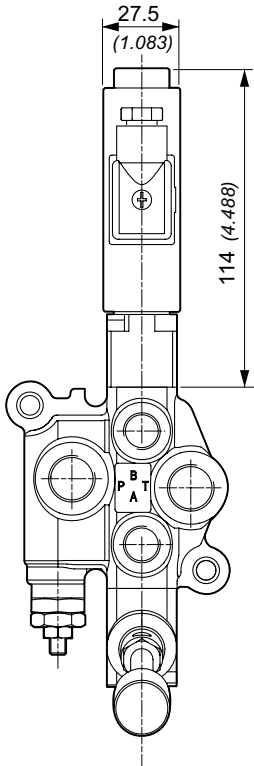
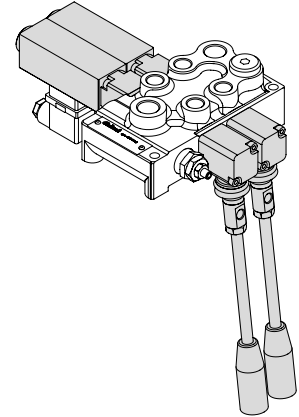
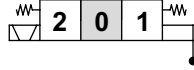

Connessione Connection		
	1 - 2	Effetto A Port A
	1 - 3	Effetto B Port B

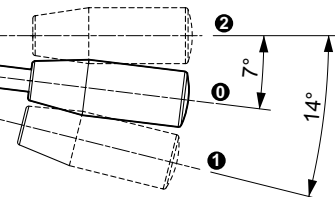

Dimensioni in / Dimensions in: mm (inch)

**Caratteristiche tecniche elettromagnete / Electromagnet technical features**

Tipo distributore / Valve type	<b>Q15 - GMV15</b>
Attacco magnete / Magnet connection	Tipo/Type DIN 43650 (vers. B1)
Tipo protezione / Protection type	IP65
Classe d'isolamento / Coil insulation class	H
Tensione di alimentazione / Supply voltage	12V D.C./24V D.C.
Variazione di tensione max / Maximum voltage tolerance	±10%
Potenza assorbita / Absorbed power supply	33W
Rapporto di massimo utilizzo / Maximum utilization ratio	100%

**Caratteristiche tecniche distributore / Directional control valve characteristics**

Portata max (lt/min) / Max. flow (Gal/min)	20 (5.3)
Pressione max di lavoro / Max. working pressure	280 bar (4060 PSI)
Contropressione max sullo scarico / Max. back outlet pressure	25 bar (3363 PSI)
Manovra di emergenza o in assenza di corrente / Emergency operation or in case of power failure	Con leva / With lever
Trafilamento max di A e B in T a 100 bar con viscosità 35 mm <sup>2</sup> /s Max. spool leakage of A and B ports to T port at 1450 PSI with viscosity 35 mm <sup>2</sup> /s	5 cm <sup>3</sup> /min

Sezione di lavoro

Working section

Limiti d'impiego / Use limits

Perdite di carico con il cursore in posizione neutra

( $\Delta p$  in funzione del numero di sezioni attraversate)  
**Pressure drop with spool in neutral position**  
 ( $\Delta p$  depending on the number of the crossed sections)

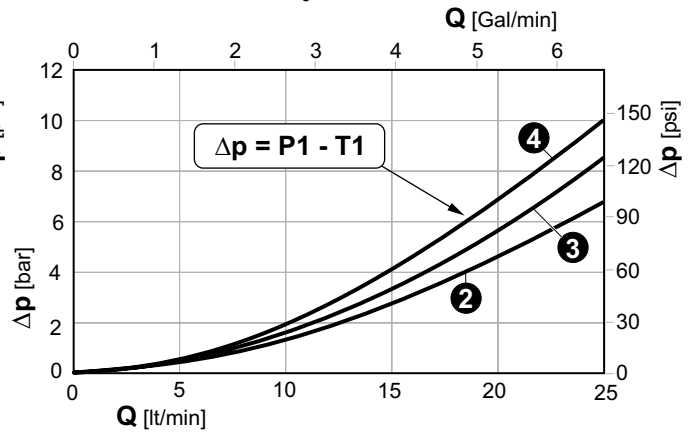
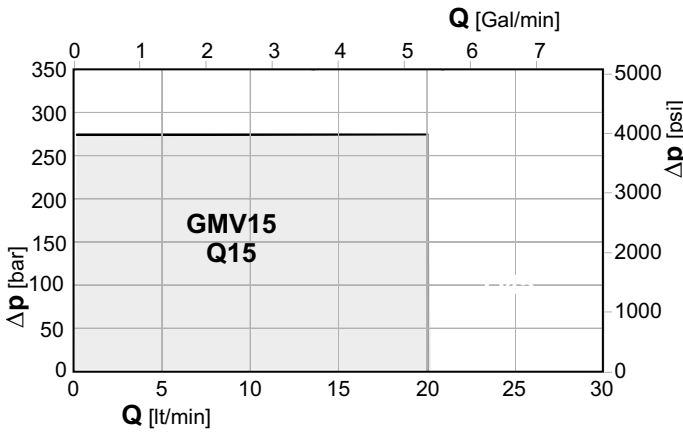
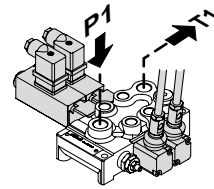

Perdite di carico con il cursore in posizione di lavoro

( $\Delta p$  in funzione del numero di sezioni attraversate)  
**Pressure drop with spool in working position**  
 ( $\Delta p$  depending on the number of the crossed sections)

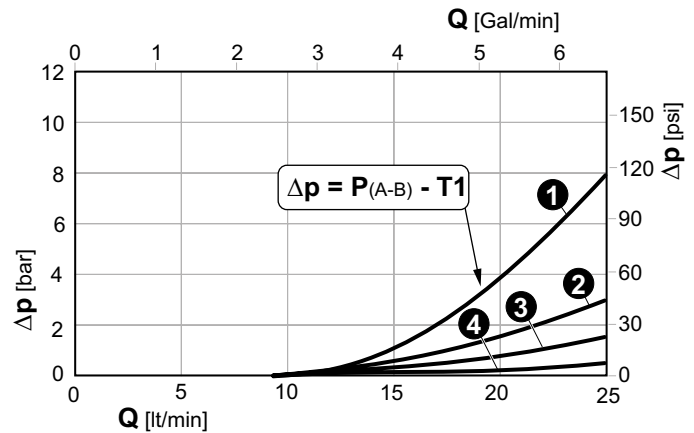
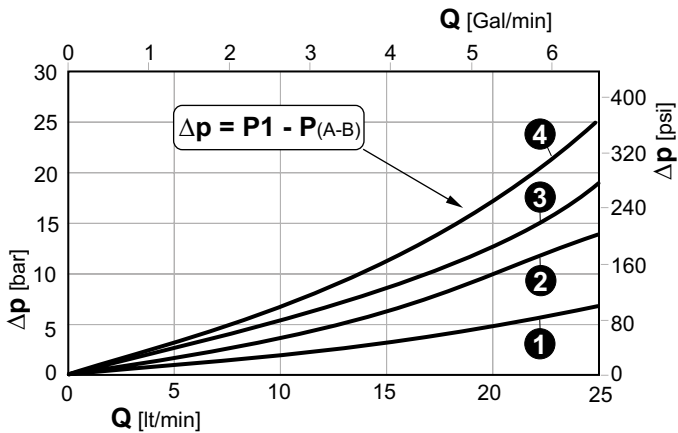
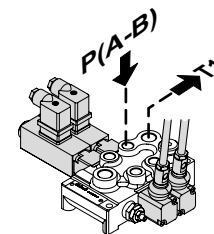
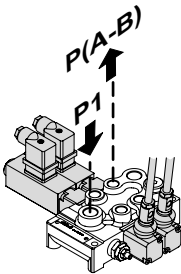

1 2 3 4 Sezioni / Sections

N.B. Le curve sono ricavate con cursore 103 / NOTE. Performance curves measured using spool 103 type.

Sezione di lavoro

Working section

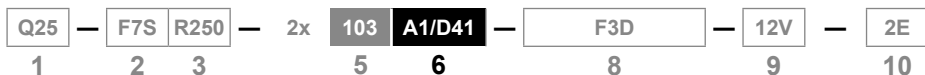

**A1/D41**

Comando elettrico diretto doppio ON/OFF con ritorno a molla in posizione 0  
 ON/OFF double direct electrical control with spring centred in 0

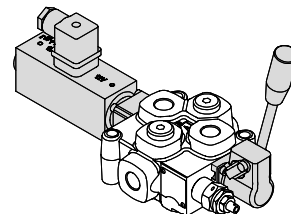

**A2/D41**

Comando elettrico diretto doppio ON/OFF ruotato di 180° con ritorno a molla in posizione 0  
 180° rotated ON/OFF double direct electrical control with spring centred in 0

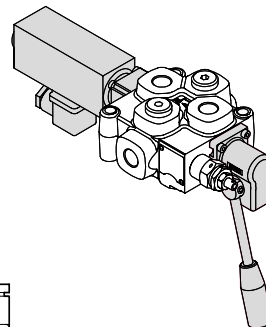
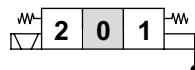

Connessione Connection		
	1 - 2	Effetto A Port A
	1 - 3	Effetto B Port B

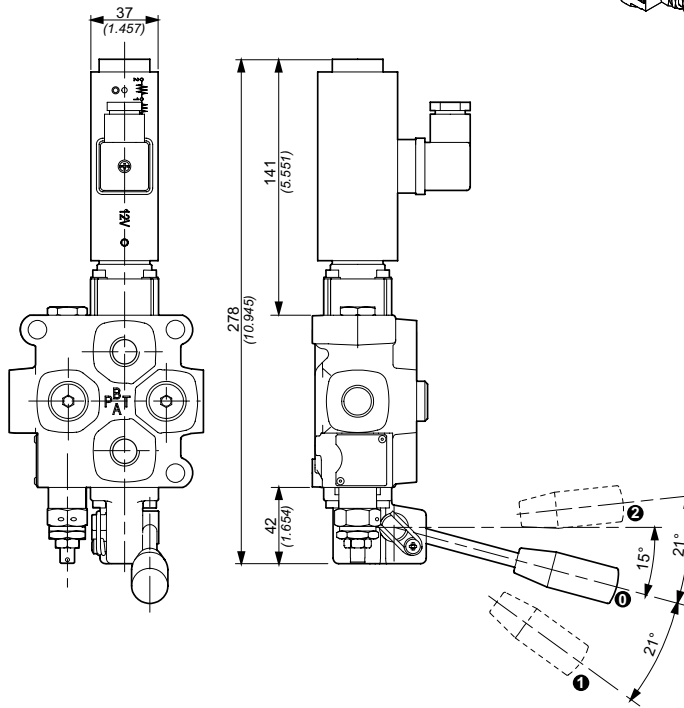

Dimensioni in / Dimensions in: mm (inch)

Caratteristiche tecniche elettromagnete / Electromagnet technical features		
Tipo distributore / Valve type	<b>Q25</b>	<b>Q45</b>
Attacco magnete / Magnet connection	Tipo/Type DIN 43650 (vers. A)	
Tipo protezione / Protection type	IP65	
Classe d'isolamento / Coil insulation class	H	
Tensione di alimentazione / Supply voltage	12V D.C./24V D.C.	
Variazione di tensione max / Maximum voltage tolerance	±10%	
Potenza assorbita / Absorbed power supply	58W	
Rapporto di massimo utilizzo / Maximum utilization ratio	100%	
Caratteristiche tecniche distributore / Directional control valve characteristics		
Portata max (lt/min) / Max. flow (Gal/min)	50 (13)	60 (16)
Pressione max di lavoro / Max. working pressure	275 bar (3988 PSI)	
Contropressione max sullo scarico / Max. back outlet pressure	25 bar (3363 PSI)	
Manovra di emergenza o in assenza di corrente / Emergency operation or in case of power failure	Con leva / With lever	
Trafilamento max di A e B in T a 100 bar con viscosità 35 mm <sup>2</sup> /s Max. spool leakage of A and B ports to T port at 1450 PSI with viscosity 35 mm <sup>2</sup> /s	5 cm <sup>3</sup> /min	

Sezione di lavoro

Working section

Limiti d'impiego / Use limits

Perdite di carico con il cursore in posizione neutra

( $\Delta p$  in funzione del numero di sezioni attraversate)  
 Pressure drop with spool in neutral position  
 ( $\Delta p$  depending on the number of the crossed sections)

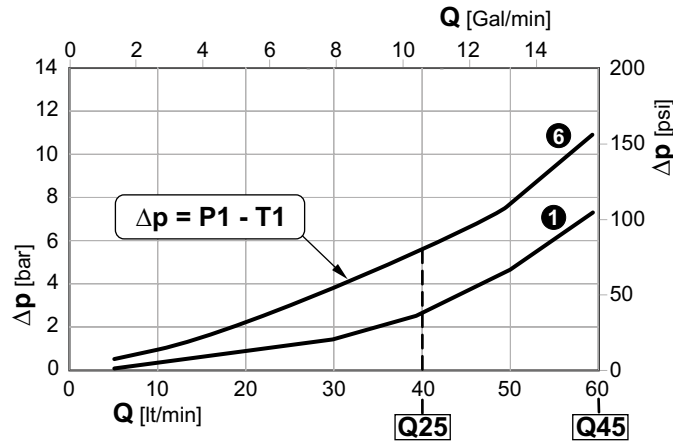
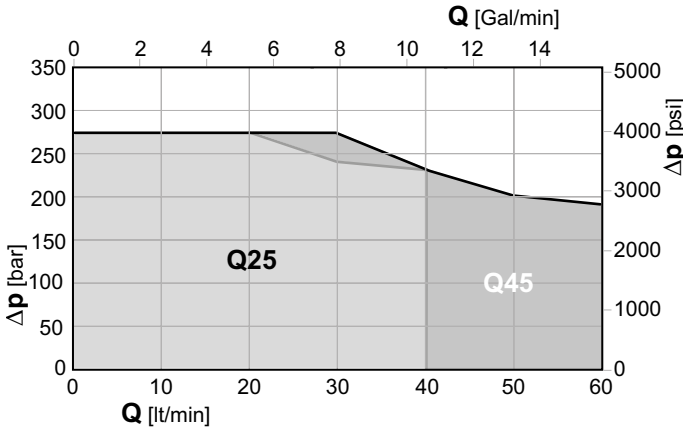
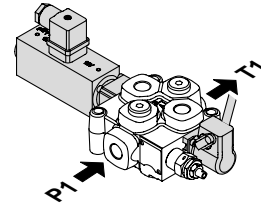

Perdite di carico con il cursore in posizione di lavoro

( $\Delta p$  in funzione del numero di sezioni attraversate)  
 Pressure drop with spool in working position  
 ( $\Delta p$  depending on the number of the crossed sections)

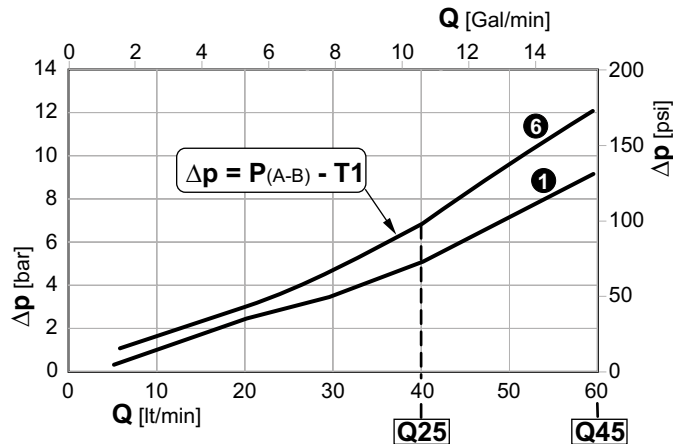
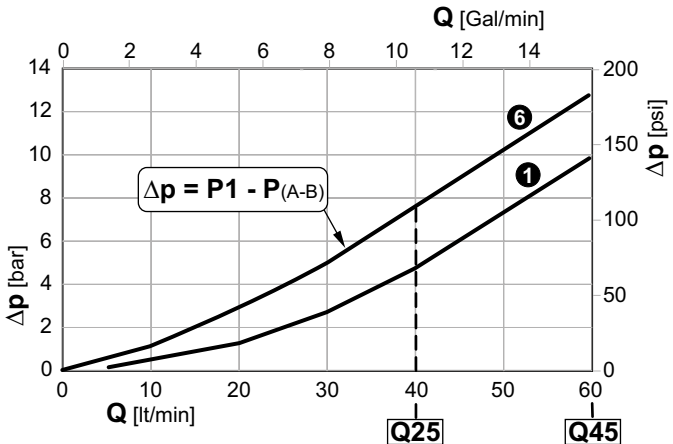
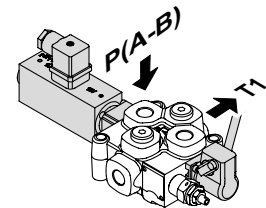
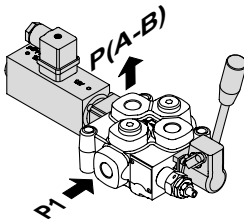

1 6 Sezioni / Sections

N.B. Le curve sono ricavate con cursore 103 / NOTE. Performance curves measured using spool 103 type.



Sezione di lavoro

Working section

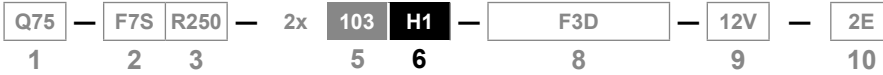

A1/D41

Comando elettrico diretto doppio ON/OFF con ritorno a molla in posizione 0  
 ON/OFF double direct electrical control with spring centred in 0

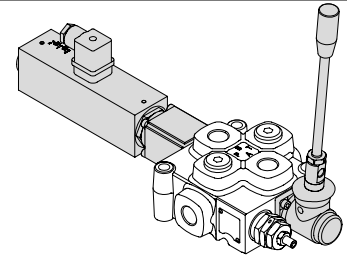
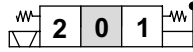

A2/D41

Comando elettrico diretto doppio ON/OFF ruotato di 180° con ritorno a molla in posizione 0  
 180° rotated ON/OFF double direct electrical control with spring centred in 0

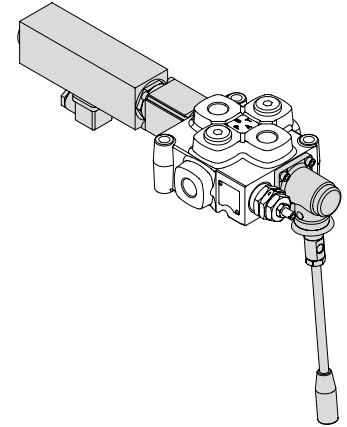
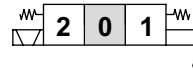

Connessione Connection		
	1 - 2	Effetto A Port A
	1 - 3	Effetto B Port B

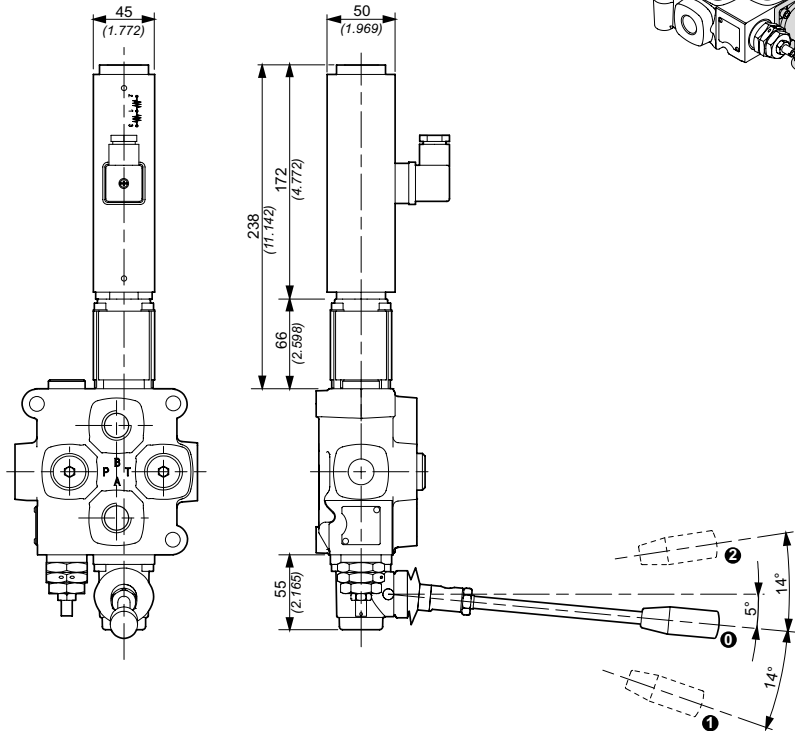

Dimensioni in / Dimensions in: mm (inch)

Caratteristiche tecniche elettromagnete / Electromagnet technical features		
Tipo distributore / Valve type	Q75	Q95
Attacco magnete / Magnet connection	Tipo/Type DIN 43650 (vers. A)	
Tipo protezione / Protection type	IP65	
Classe d'isolamento / Coil insulation class	H	
Tensione di alimentazione / Supply voltage	12V D.C./24V D.C.	
Variazione di tensione max / Maximum voltage tolerance	±10%	
Potenza assorbita / Absorbed power supply	80W	
Rapporto di massimo utilizzo / Maximum utilization ratio	100%	
Caratteristiche tecniche distributore / Directional control valve characteristics		
Portata max (lt/min) / Max. flow (Gal/min)	90 (24)	120 (32)
Pressione max di lavoro / Max. working pressure	300 bar	
Contropressione max sullo scarico / Max. back outlet pressure	25 bar	
Manovra di emergenza o in assenza di corrente / Emergency operation or in case of power failure	Con leva / With lever	
Trafilamento max di A e B in T a 100 bar con viscosità 35 mm <sup>2</sup> /s Max. spool leakage of A and B ports to T port at 1450 bar with viscosity 35 mm <sup>2</sup> /s	5 cm <sup>3</sup> /min	

Sezione di lavoro

Working section

Limiti d'impiego / Use limits

Perdite di carico con il cursore in posizione neutra

( $\Delta p$  in funzione del numero di sezioni attraversate)  
 Pressure drop with spool in neutral position  
 ( $\Delta p$  depending on the number of the crossed sections)

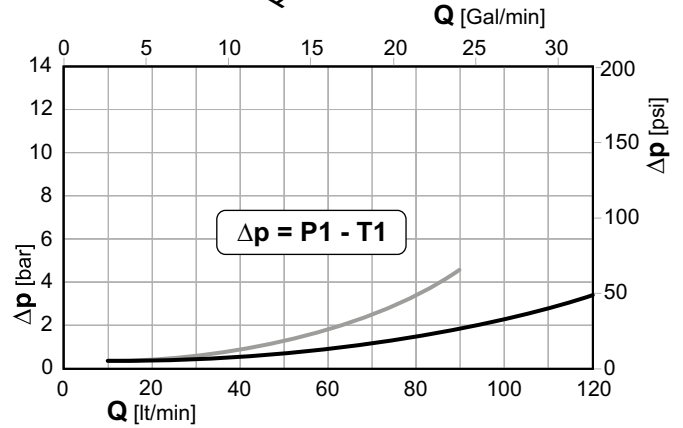
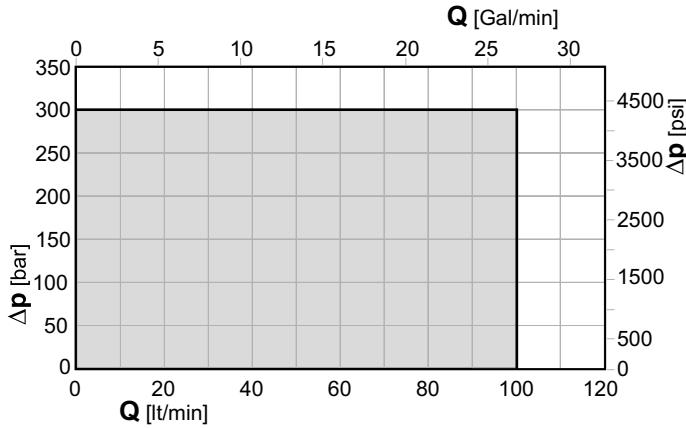
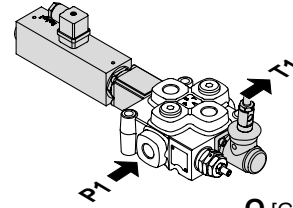

Perdite di carico con il cursore in posizione di lavoro

( $\Delta p$  in funzione del numero di sezioni attraversate)  
 Pressure drop with spool in working position  
 ( $\Delta p$  depending on the number of the crossed sections)

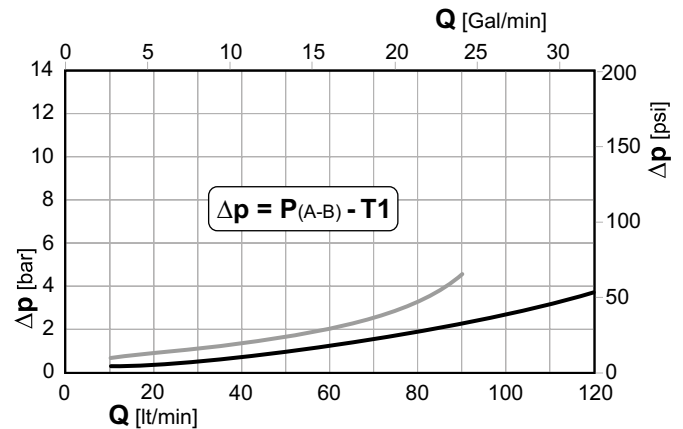
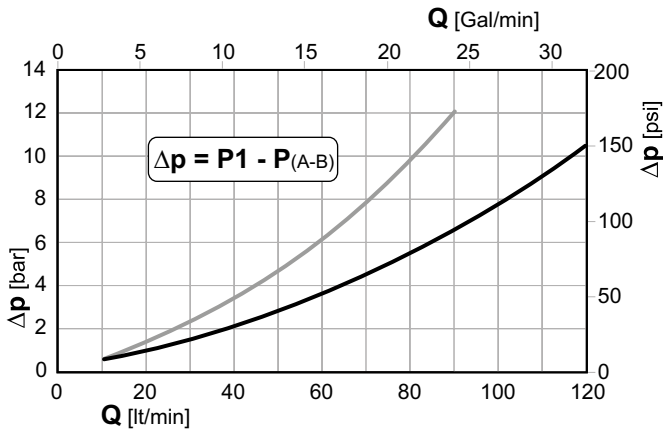
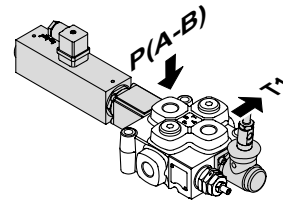
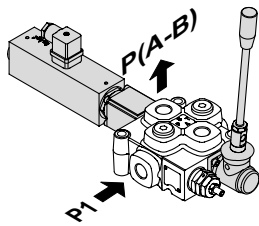

- 1 Elemento Q95 / 1 section Q95
- - - 1 Elemento Q75 / 1 section Q75

N.B. Le curve sono ricavate con cursore 103 / NOTE. Performance curves measured using spool 103 type.

Sezione di lavoro

Working section

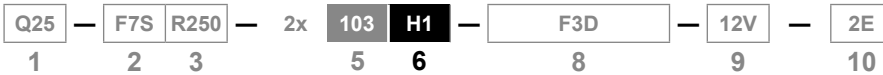

A1/DP

Comando elettrico diretto doppio con magnete proporzionale e ritorno a molla in posizione 0  
 Double direct electrical control with proportional solenoid and spring centred in 0

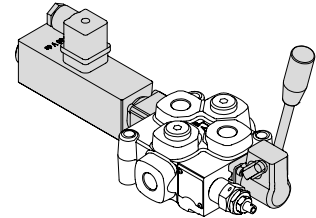
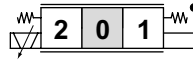

A2/DP

Comando elettrico diretto doppio con magnete proporzionale ruotato di 180° e ritorno a molla in posizione 0  
 180° rotated double direct electrical control with proportional solenoid and spring centred in 0

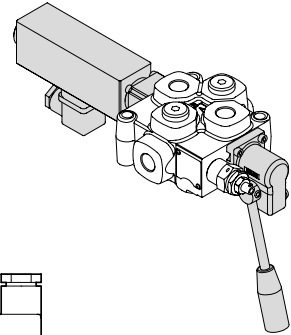
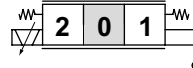

Connessione Connection		
	1 - 2	Effetto A Port A
	1 - 3	Effetto B Port B

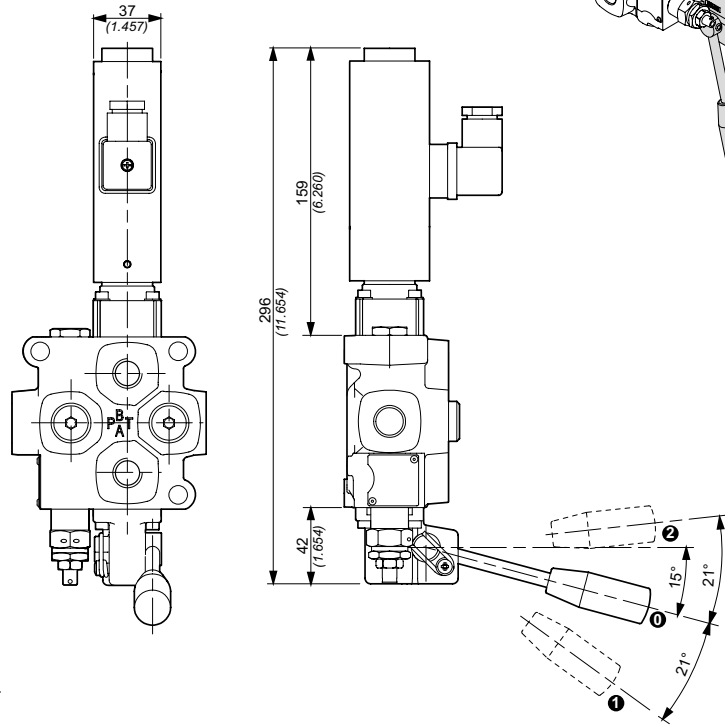

Per l'elettronica di comando contattare l'ufficio commerciale.  
 For electronic control unit contact the sales office.

Dimensioni in / Dimensions in: mm (inch)

Caratteristiche tecniche elettromagnete / Electromagnet technical features		
Tipo distributore / Valve type	<b>Q25</b>	<b>Q45</b>
Attacco magnete / Magnet connection	Tipo/Type DIN 43650 (vers. A)	
Tipo protezione / Protection type	IP65	
Classe d'isolamento / Coil insulation class	H	
Tensione di alimentazione / Supply voltage	12 VDC	24 VDC
Corrente di regolazione massima / Current maximum range	5A	2.5A
PWM frequency	100 Hz	
Caratteristiche tecniche / Technical characteristics		
Portata max (lt/min) / Max. flow (Gal/min)	30 (8)	60 (16)
Pressione max di lavoro / Max. working pressure	250 bar	
Contropressione max sullo scarico / Max. back outlet pressure	25 bar	
Manovra di emergenza o in assenza di corrente / Emergency operation or in case of power failure	Con leva / With lever	
Trafilamento max di A e B in T a 100 bar con viscosità 35 mm <sup>2</sup> /s Max. spool leakage of A and B ports to T port at 1450 bar with viscosity 35 mm <sup>2</sup> /s	5 cm <sup>3</sup> /min	

Sezione di lavoro

Working section

Limiti d'impiego / Use limits

Perdite di carico con il cursore in posizione neutra

( $\Delta p$  in funzione del numero di sezioni attraversate)  
 Pressure drop with spool in neutral position  
 ( $\Delta p$  depending on the number of the crossed sections)

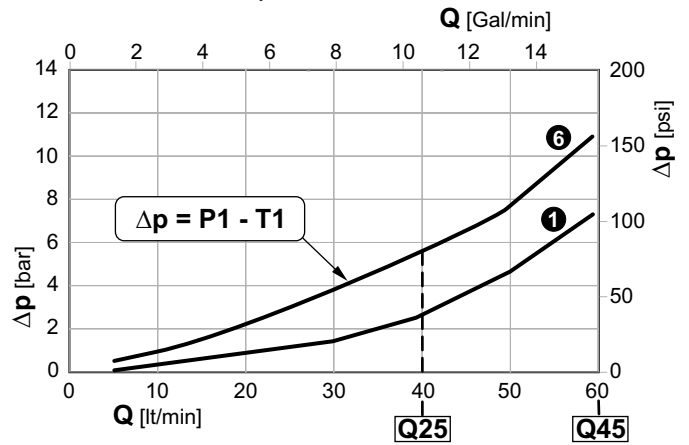
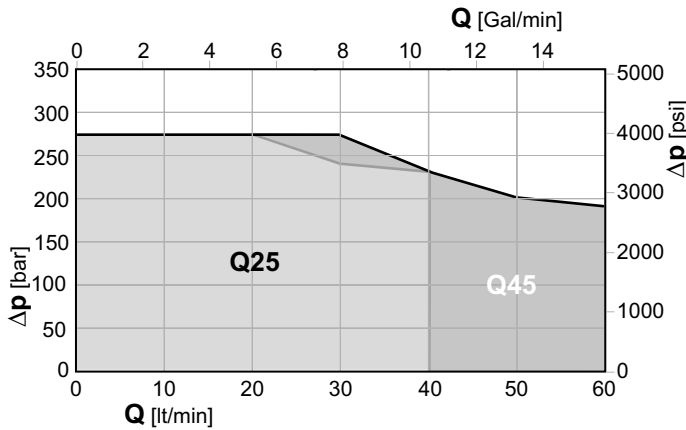
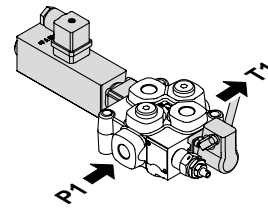

N.B. Le curve sono ricavate con cursore 103 / NOTE. Performance curves measured using spool 103 type.

① ⑥ Sezioni / Sections

Curve di metering corrente bassa portata  $Q_{in}$  30 l/min  
 Metering curve current low delivery  $Q_{in}$  30 l/min

Curve di metering corrente bassa portata  $Q_{in}$  60 l/min  
 Metering curve current low delivery  $Q_{in}$  60 l/min

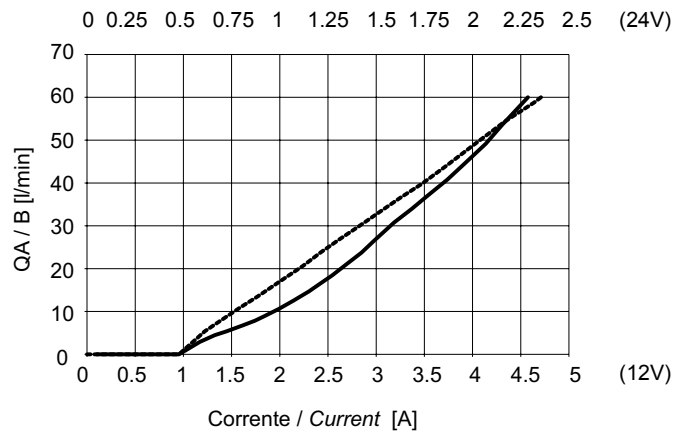
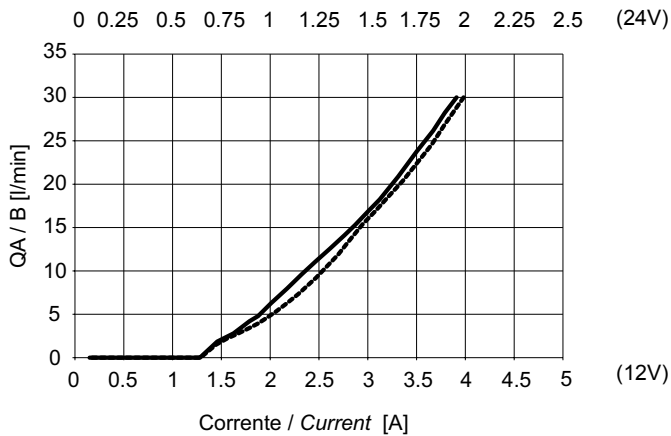

--- Cursore 111 / Spool 111 type  
 — Cursore 103 / Spool 103 type

Sezione di lavoro

Working section



D9

Comando elettrico diretto doppio ON/OFF con ritorno a molla in posizione 0  
 ON/OFF double direct electrical control with spring centred in 0

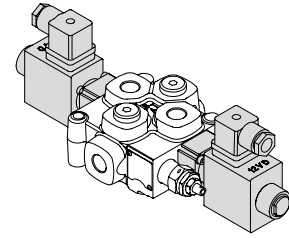
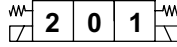

Connessione Connection		
	1 - 2	Effetto A Port A
	1 - 3	Effetto B Port B

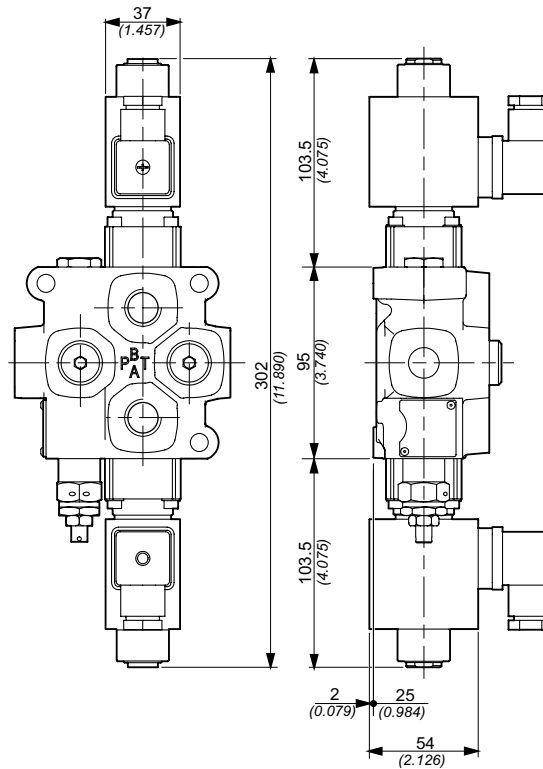

Dimensioni in / Dimensions in: mm (inch)

Caratteristiche tecniche elettromagnete / Electromagnet technical features		
Tipo distributore / Valve type	Q25	Q45
Attacco magnete / Magnet connection	Tipo/Type DIN 43650 (vers. A)	
Tipo protezione / Protection type	IP65	
Classe d'isolamento / Coil insulation class	H	
Tensione di alimentazione / Supply voltage	12V D.C./24V D.C.	
Variazione di tensione max / Maximum voltage tolerance	±10%	
Potenza assorbita / Absorbed power supply	58W	
Rapporto di massimo utilizzo / Maximum utilization ratio	100%	
Caratteristiche tecniche distributore / Directional control valve characteristics		
Portata max / Max. flow	50	60
Pressione max di lavoro / Max. working pressure	275 bar	
Contropressione max sullo scarico / Max. back outlet pressure	25 bar	
Manovra di emergenza o in assenza di corrente / Emergency operation or in case of power failure	A pulsante in spinta / Push type	
Trafilamento max di A e B in T a 100 bar con viscosità 35 mm <sup>2</sup> /s / Max. spool leakage of A and B ports to T port at 100 bar with viscosity 35 mm <sup>2</sup> /s	5 cm <sup>3</sup> /min	

Sezione di lavoro

Working section

Limiti d'impiego / Use limits

Perdite di carico con il cursore in posizione neutra

( $\Delta p$  in funzione del numero di sezioni attraversate)  
 Pressure drop with spool in neutral position  
 ( $\Delta p$  depending on the number of the crossed sections)

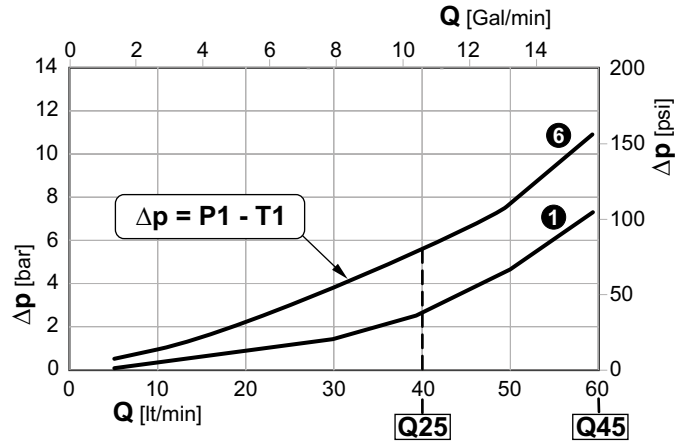
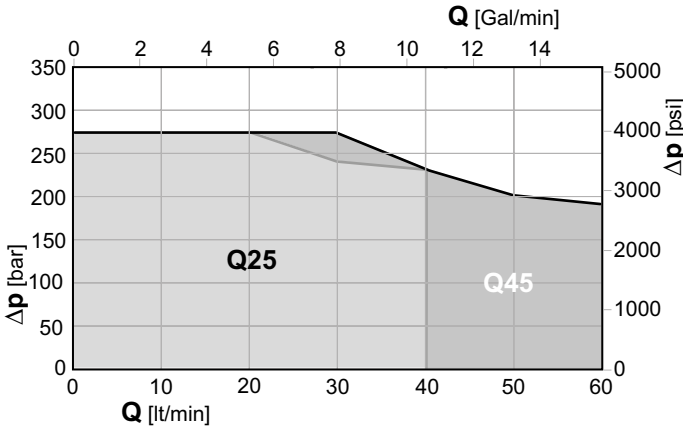
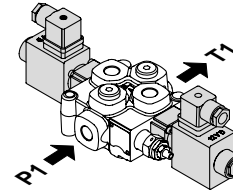

Perdite di carico con il cursore in posizione di lavoro

( $\Delta p$  in funzione del numero di sezioni attraversate)  
 Pressure drop with spool in working position  
 ( $\Delta p$  depending on the number of the crossed sections)

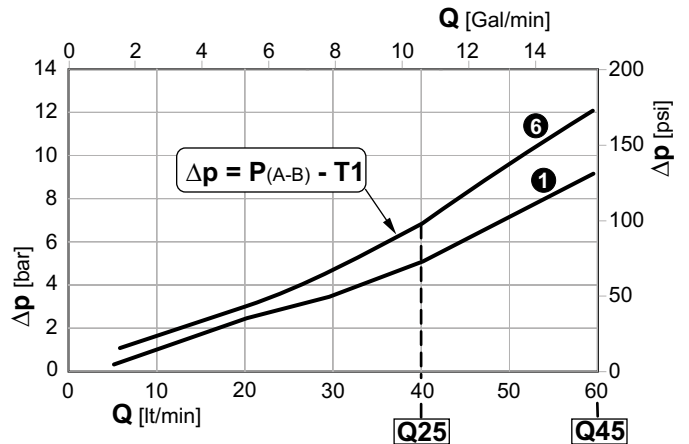
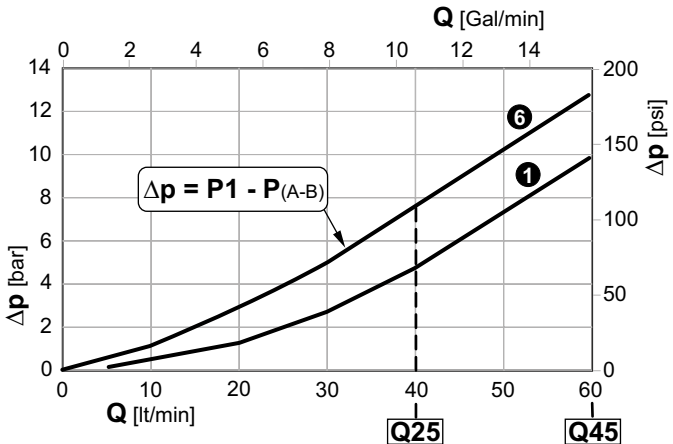
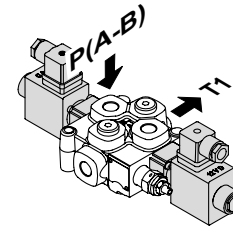
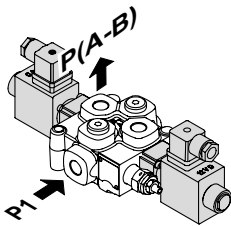

① ⑥ Sezioni / Sections

N.B. Le curve sono ricavate con cursore 103 / NOTE. Performance curves measured using spool 103 type.

Q75	F7S	R250	2x	103	H1	F3D	12V	2E
1	2	3		5	6	8	9	10

## D9

Comando elettrico diretto doppio ON/OFF  
con ritorno a molla in posizione 0  
ON/OFF double direct electrical control  
with spring centred in 0

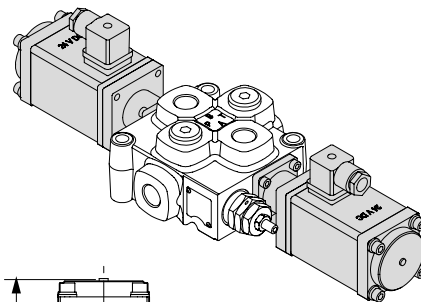
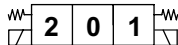

Connessione Connection		
	1 - 2	Effetto A Port A
	1 - 3	Effetto B Port B

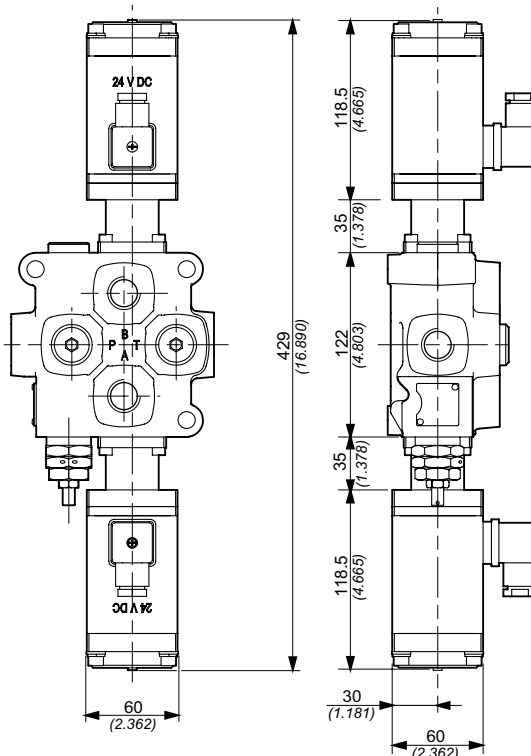

Dimensioni in / Dimensions in: mm (inch)

Caratteristiche tecniche elettromagnete / Electromagnet technical features		
Tipo distributore / Valve type	Q75	Q95
Attacco magnete / Magnet connection	Tipo/Type DIN 43650 (vers. A)	
Tipo protezione / Protection type	IP65	
Classe d'isolamento / Coil insulation class	H	
Tensione di alimentazione / Supply voltage	12V D.C./24V D.C.	
Variazione di tensione max / Maximum voltage tolerance	±10%	
Potenza assorbita / Absorbed power supply	80W	
Rapporto di massimo utilizzo / Maximum utilization ratio	100%	
Caratteristiche tecniche distributore / Directional control valve characteristics		
Portata max / Max. flow	90	120
Pressione max di lavoro / Max. working pressure	210 bar	
Contropressione max sullo scarico / Max. back outlet pressure	25 bar	
Manovra di emergenza o in assenza di corrente / Emergency operation or in case of power failure	A pulsante in spinta / Push type	
Trafilamento max di A e B in T a 100 bar con viscosità 35 mm <sup>2</sup> /s / Max. spool leakage of A and B ports to T port at 100 bar with viscosity 35 mm <sup>2</sup> /s	7 cm <sup>3</sup> /min	

Sezione di lavoro

Working section

Limiti d'impiego / Use limits

Perdite di carico con il cursore in posizione neutra

( $\Delta p$  in funzione del numero di sezioni attraversate)  
**Pressure drop with spool in neutral position**  
 ( $\Delta p$  depending on the number of the crossed sections)

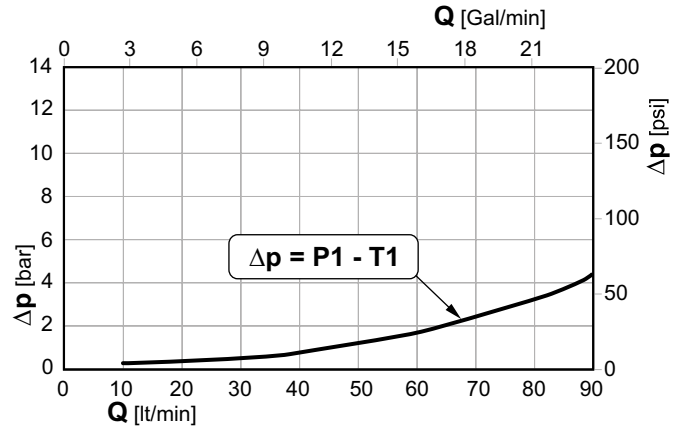
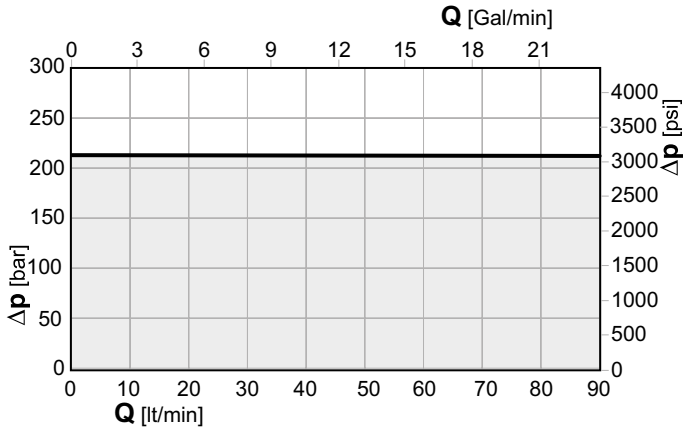
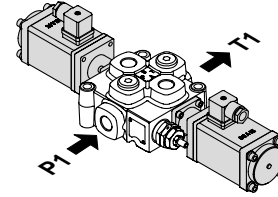

Perdite di carico con il cursore in posizione di lavoro

( $\Delta p$  in funzione del numero di sezioni attraversate)  
**Pressure drop with spool in working position**  
 ( $\Delta p$  depending on the number of the crossed sections)

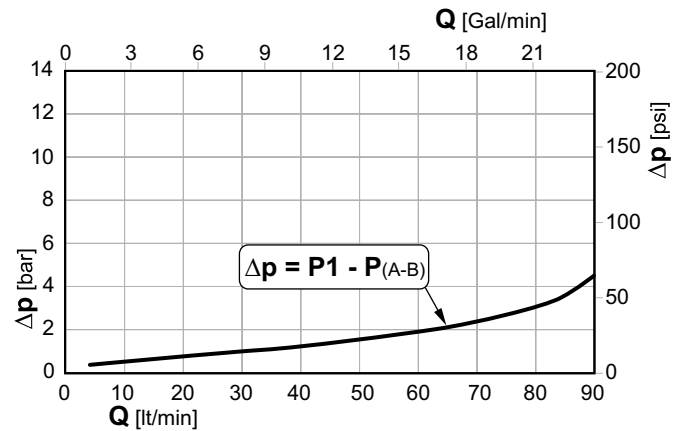
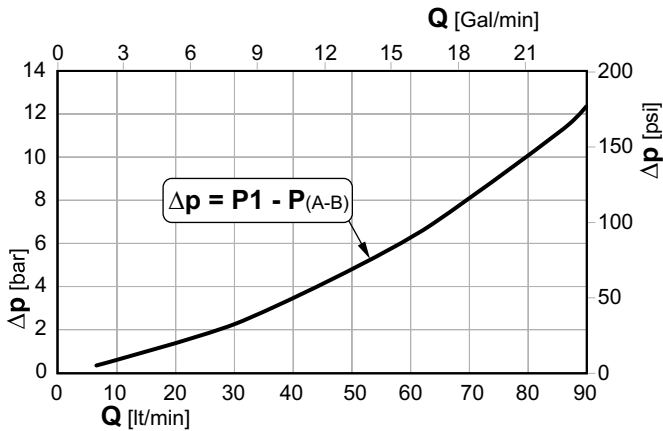
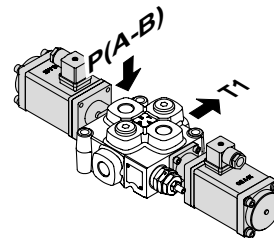
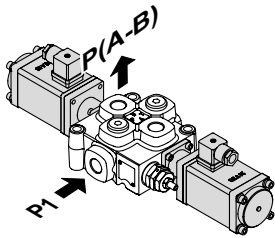

N.B. Le curve sono ricavate con cursore 103 / NOTE. Performance curves measured using spool 103 type.



**Fiancata di scarico**

**Outlet section type**



**8 - Tipo fiancata di scarico / Outlet section type**

	Q15	GMV 15	Q35	Q25	Q45	Q65	Q75	Q95
<b>F3D</b>		•	•	•	•	•	•	•
<b>F6D</b>			•	•	•	•	•	•
<b>F16D</b>		•		•	•	•	•	•

**F3D**

Fiancata di scarico  
Outlet section

**F6D**

Fiancata di scarico con alimentazione in pressione per altri componenti (carry-over)  
Outlet section and high pressure (carry-over)

Per il GMV15 vedere l'installazione del carry-over a pag. F10  
For GMV15 Carry Over installation see page F10

**F16D**

Fiancata di scarico destro per centro chiuso  
Right outlet section for through passage closed

Per il GMV15 vedere l'installazione del carry-over a pag. F10  
For GMV15 Carry Over installation see page F10

## Note aggiuntive

## Additional notes

Q25	F7S	R250	2x	103	A1	M1	F3D	12V	2E
1	2	3		5	6	7	8	9	10

## 9 - Note aggiuntive / Additional notes

12V, 24V

S Alluminio (pag. F-6 ... F-10)

Codice asta di comando (vedi tabella seguente)

## 8 - Additional notes

12V, 24V

S Aluminium (page F-6 ... F-10)

Control lever code (see next table)

Codice / Code	Versione / Version	M	L	D	A	B	Colore / Color
---------------	--------------------	---	---	---	---	---	----------------

Q35 - Q15 - GMV15 - Q25 - Q45		Dimensioni in / Dimensions in: mm (inch)						
06.029.22862	1	Standard / Standard	M8	164 (6.457)	20 (0.787)	57 (2.244)	20 (0.787)	Nero / Black
06.029.30335	1	Standard / Standard	M8	164 (6.457)	20 (0.787)	57 (2.244)	20 (0.787)	Rosso / Red
06.029.30528	1	Lunga tipo A / Long version type A	M8	184 (7.244)	20 (0.787)	57 (2.244)	20 (0.787)	Nero / Black
06.029.30492	1	Lunga tipo A / Long version type A	M8	184 (7.244)	20 (0.787)	57 (2.244)	20 (0.787)	Rosso / Red
06.029.28922	1	Lunga / Long version	M8	204 (8.031)	20 (0.787)	57 (2.244)	20 (0.787)	Nero / Black
06.029.30336	1	Lunga / Long version	M8	204 (8.031)	20 (0.787)	57 (2.244)	20 (0.787)	Rosso / Red
06.029.27421	1	Extra lunga / Extra-long	M8	324 (12.756)	20 (0.787)	57 (2.244)	20 (0.787)	Nero / Black
06.029.22876	1	Extra corta / Extra-short	M8	82 (3.228)	18 (0.709)	50 (1.969)	20 (0.787)	Nero / Black
06.029.29451	2	Standard con oblo' / Standard with lens	M8	174 (6.850)	32 (1.260)	46 (1.811)	20 (0.787)	Nero / Black
06.029.29423	2	Lunga con oblo' / Long with lens	M8	214 (8.425)	32 (1.260)	46 (1.811)	20 (0.787)	Nero / Black

Q75 - Q95		Dimensioni in / Dimensions in: mm (inch)						
06.029.27013	1	Standard / Standard	M10	209 (8.228)	20 (0.787)	57 (2.244)	28 (1.102)	Nero / Black
06.029.28148	1	Lunga / Long version	M10	357 (14.055)	20 (0.787)	57 (2.244)	28 (1.102)	Nero / Black
06.029.27344	1	Corta / Short version	M10	154 (6.063)	20 (0.787)	57 (2.244)	28 (1.102)	Nero / Black
06.029.27635	1	Extra corta / Extra-short	M10	66 (2.598)	26 (1.024)	42 (1.654)	22 (0.866)	Nero / Black
06.029.29866	2	Standard con oblo' / Standard with lens	M10	219 (8.622)	32 (1.260)	46 (1.811)	28 (1.102)	Nero / Black
06.029.30295	2	Lunga con oblo' / Long with lens	M10	367 (14.449)	32 (1.260)	46 (1.811)	28 (1.102)	Nero / Black

Per comando elettrico / For electric control Q25 - Q45		Dimensioni in / Dimensions in: mm (inch)						
06.029.28945	1	Standard / Standard	Ø7	133 (5.236)	20 (0.787)	57 (2.244)	15 (0.591)	Nero / Black
06.029.29349	1	Lunga / Long version	Ø7	201 (7.913)	20 (0.787)	57 (2.244)	15 (0.591)	Nero / Black
06.029.30951	2	Standard con oblo' / Standard with lens	Ø7	143 (5.630)	32 (1.260)	46 (1.811)	15 (0.591)	Nero / Black

Dimensioni in / Dimensions in: mm (inch)

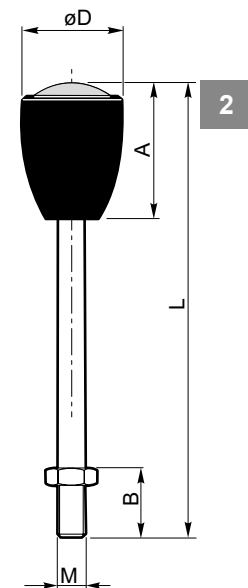
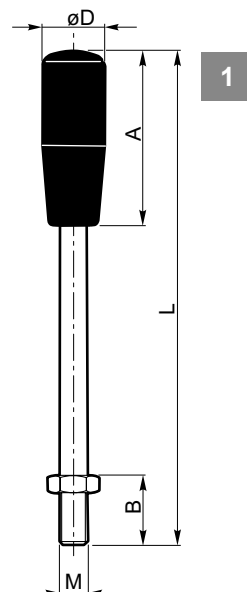

## Note aggiuntive

## Additional notes

Q25	F7S	R250	2x	103	A1	M1	F3D	12V	2E
1	2	3		4	5	6	7	8	9

## 10 - Numero elementi

Specificare il numero delle sezioni di lavoro previste (es. 2E).

## 10 - Number of sections

Specify the number of working sections used (e.g. 2E).

## ESEMPI DI ORDINAZIONE IN CODICE ORDERING CODE EXAMPLES

Q25 - F1S R(250) - 103/A1/M1 - 103/A1/D41 - 103/A1/DP - F3D - 12V - 3E

A	B		C				D	E	
1	2	3	5 - 6 - 7				8	9 - 10	
Q25	F1S	R250	103/A1/M1				F3D	12V - 3E	
			103/A1/D41						
			103/A1/DP						

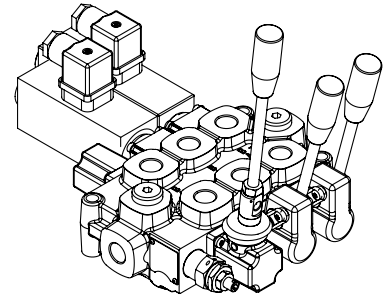

Schema idraulico  
Hydraulic symbol

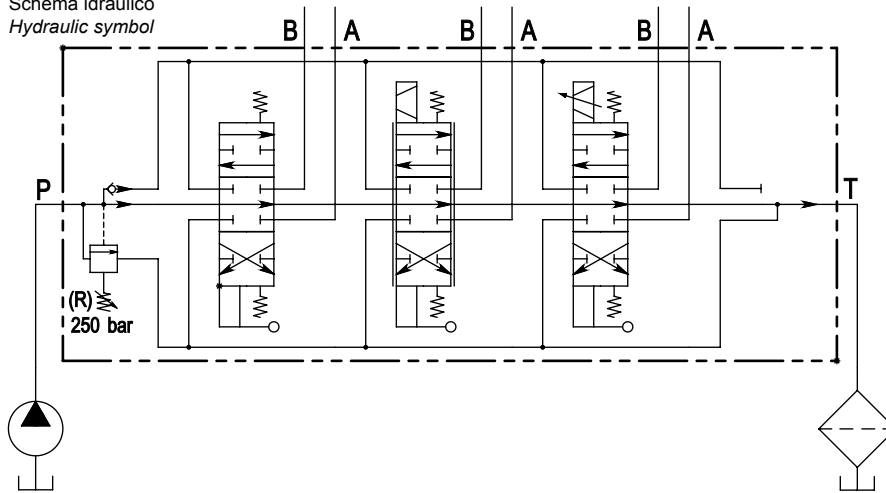

Q25 - F1S(N) - 103/M1/A352 - 103/M1/V30(N) - 2x103/M1/A1 - 103/M1/A354/V30(N) - 103/M1/V32(N) - F3D - 6E

A	B		C				D	E	
1	2	3	5 - 6 - 7				8	9 - 10	
Q25	F1S	N190	103/M1/A352				F3D	6E	
			103/M1/V30(N)						
			2x 103/M1/A1						
			103/M1/A354/V30(N)						
			103/M1/V32(N)						

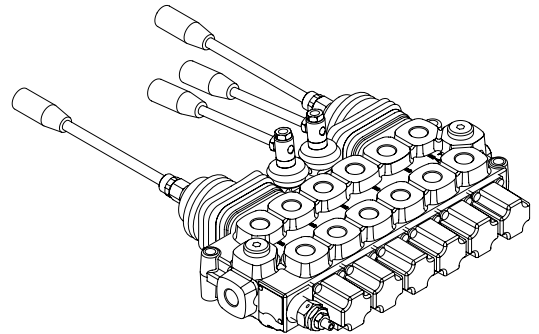

Schema idraulico  
Hydraulic symbol

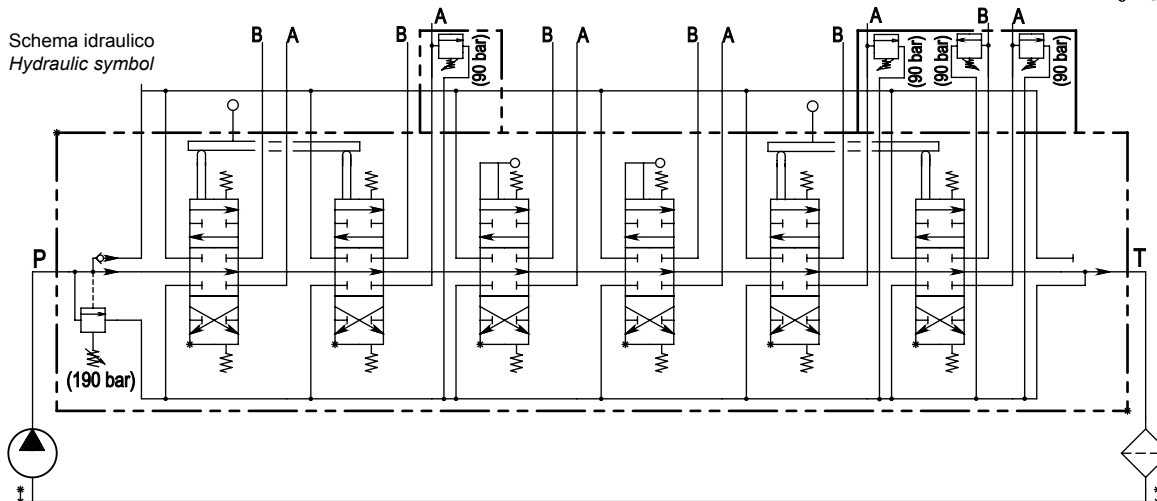

- A - Tipo / Type
- B - Fiancata d'ingresso / Inlet section
- C - Sezione di lavoro / Working section
- D - Fiancata di scarico / Outlet section
- E - Note aggiuntive / Additional notes

ESEMPI DI ORDINAZIONE IN CODICE  
ORDERING CODE EXAMPLES

Q25 - F1S(N) - 4x103/H5 - F6D - 4E

A	B		C			D	E	
1	2	3	5 - 6 - 7			8	9 - 10	
Q25	F1S	N180	4x 103/H5			F6D	4E	

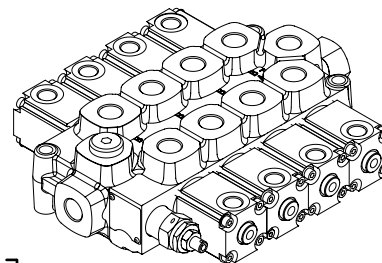

Schema idraulico  
Hydraulic symbol

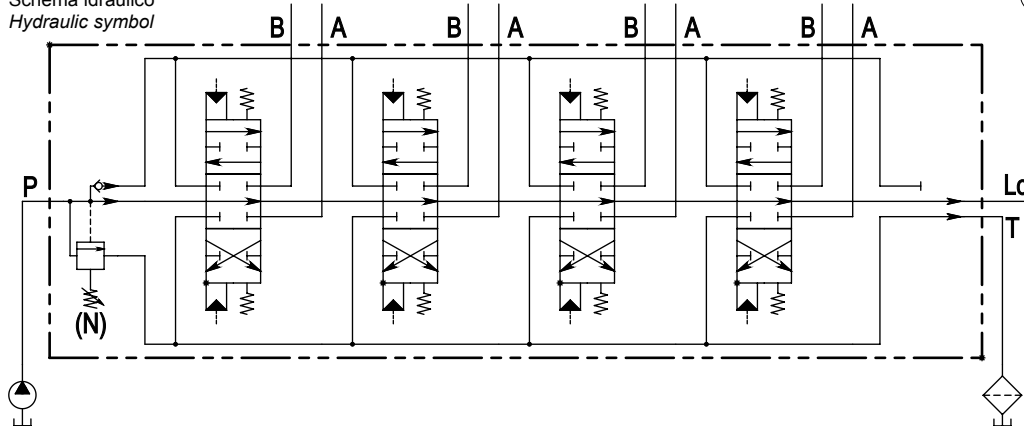

Q45 - F1S(N) - 103/A8/M1 - 116/A8-Z1/R8 - F3D - 2E

A	B		C			D	E	
1	2	3	5 - 6 - 7			8	9 - 10	
Q45	F1S	R250	103/A8/M1 116/A8-Z1/R8			F3D	2E	

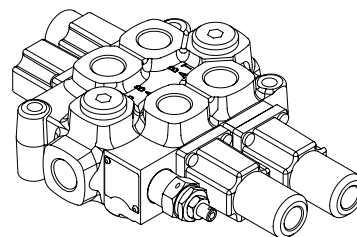

Schema idraulico  
Hydraulic symbol

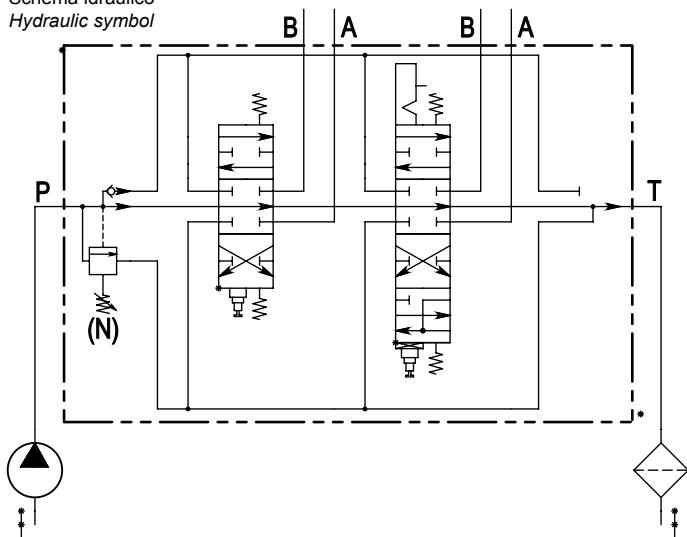

- A - Tipo / Type
- B - Fiancata d'ingresso / Inlet section
- C - Sezione di lavoro / Working section
- D - Fiancata di scarico / Outlet section
- E - Note aggiuntive / Additional notes

ESEMPI DI ORDINAZIONE IN CODICE  
ORDERING CODE EXAMPLES

Q25 - F1S (N) - 111/A1/D3 - 2x103/A1/D3 - 3x103/A1/M1 - F3D - S 24V - 6E

A	B		C			D	E	
1	2	3	5 - 6 - 7			8	9 - 10	
Q25	F1S	N180	111/A1/D3			F3D	S 24V - 6E	
			2x 103/A1/D3					
			3x 103/A1/M1					

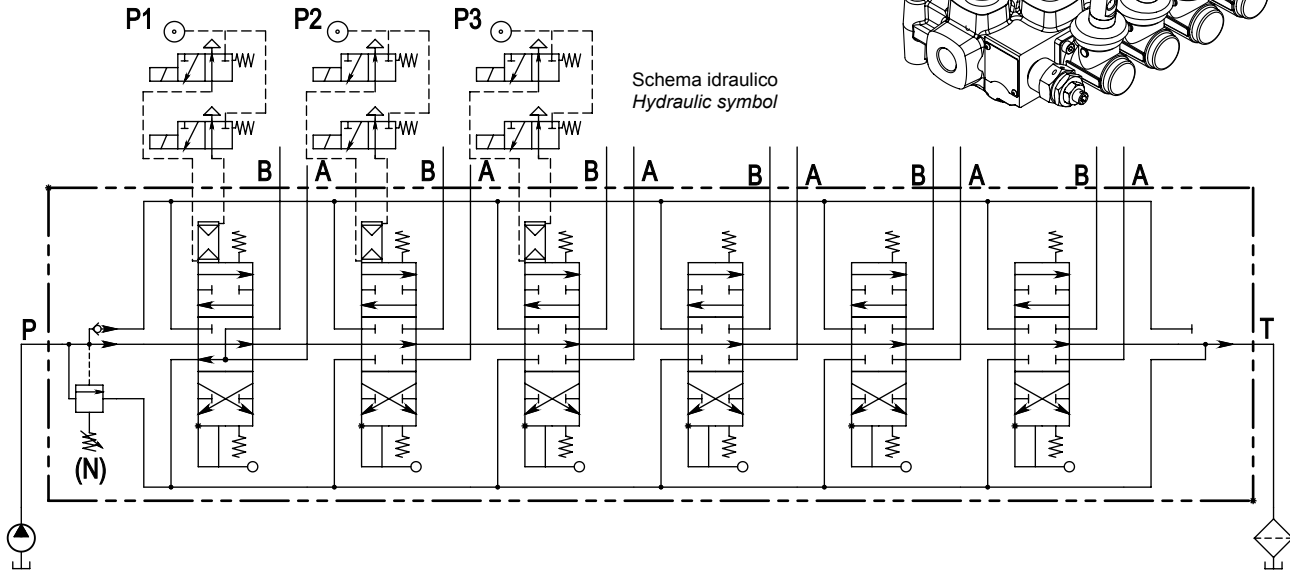
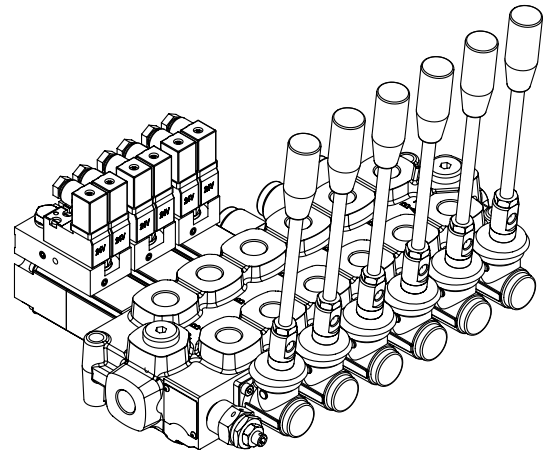

Q75 - F8S(N) - 3x103/A4/M1 - F6D - 3E

A	B		C			D	E	
1	2	3	5 - 6 - 7			8	9 - 10	
Q75	F8S	N180	3x 103/A4/M1			F6D	3E	

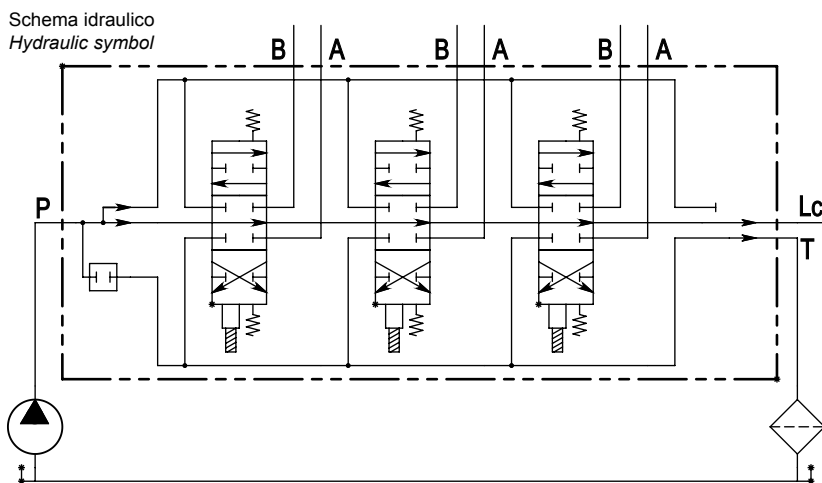
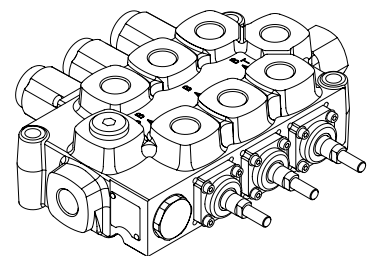

- A - Tipo / Type
- B - Fiancata d'ingresso / Inlet section
- C - Sezione di lavoro / Working section
- D - Fiancata di scarico / Outlet section
- E - Note aggiuntive / Additional notes

## DISTRIBUTORI COMPONIBILI SECTIONAL DIRECTIONAL CONTROL VALVES



Pag.  
Page

<b>CARATTERISTICHE</b> <b>FEATURES</b>	B-2
<b>CARATTERISTICHE TECNICHE</b> <b>TECHNICAL CHARACTERISTICS</b>	B-3
<b>ESEMPIO DI ORDINAZIONE IN CODICE</b> <b>ORDERING CODE EXAMPLE</b>	B-4
<b>Q30</b>	B-6
<b>GSV50</b>	B-8
<b>Q80</b>	B-10
<b>Q130</b>	B-12

## CARATTERISTICHE

- Elevate prestazioni tecniche che consentono una vasta applicazione.
- Corpo in ghisa speciale ad alta resistenza per essere adatto alle alte pressioni di lavoro.
- Cursori nichelati ad alto scorrimento che permettono di poter lavorare ad alte pressioni con lunga durata di vita.
- Trafilamenti di valore ridottissimo.
- Possibilità di inversione del lato di comando ruotando il cursore di 180°, consentendo così unificazione, versatilità, bassi valori di particolari a magazzino.
- Il tipo di libera circolazione a "Y" permette alte portate con basse perdite di carico, in rapporto alle ridotte dimensioni del distributore.
- Maggior versatilità rispetto ai distributori monoblocco e prestazioni superiori.
- Esecuzione standard con valvole di ritegno su ogni effetto.
- Protezione dei singoli effetti con valvole ausiliarie antiurto, anticavitazione e combinate.
- Possibilità di diversi tipi di circuito: PARALLELO, SERIE, SINGOLO.
- Entrate e scarichi laterali ed intermedi.
- Possibilità di inserimento di elementi intermedi con vari tipi di valvole nel medesimo distributore.

## CHARACTERISTICS

- *High technical performances granting larger application range.*
- *Special high resistance cast-iron body, suitable for high working pressures.*
- *Nickel-plated offering granting long working life under high pressure conditions (see attached scheme).*
- *Minimal internal leakages.*
- *Possibility to reverse the control side, turning the spool of 180° permits unification, versatility and low value of some parts in stock.*
- *Free movement version "Y shape" allows high oil flow with low pressure drops, in relation with the small dimensions of the control valves.*
- *Better versatility compared to monoblock control valves and higher performances.*
- *Standard check valves on each element.*
- *Protection on single elements with auxiliary antishock, anti-cavitation and combined valves.*
- *Possibility of different types of circuit: PARALLEL, SERIES and SINGLE.*
- *Side and intermediate inlets and outlets.*
- *Possibility to connect intermediate elements with different type of valves in the same control valves.*

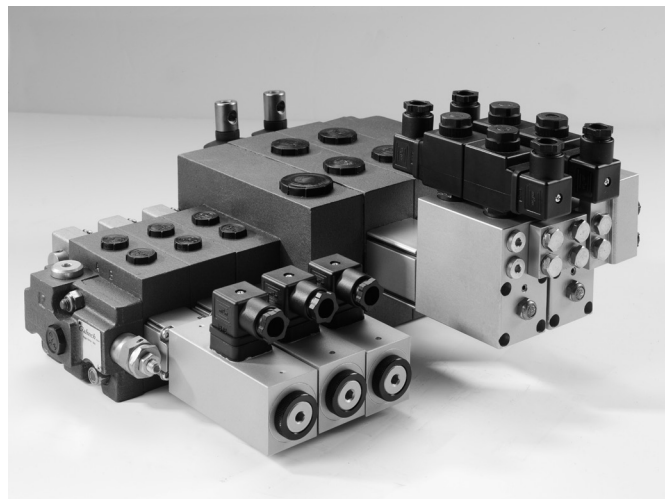
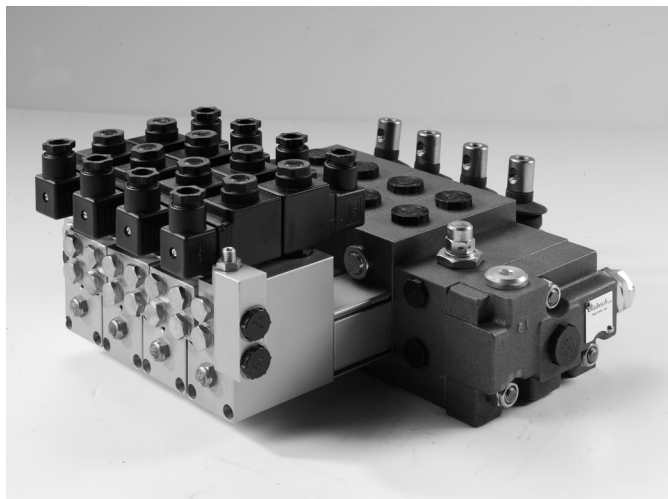

### AVVERTENZA PER L'INSTALLAZIONE DEI DISTRIBUTORI

- I distributori devono sempre appoggiare su una superficie perfettamente piana
- Non manomettere i dadi dei tiranti in quanto comprometterebbero il normale funzionamento del distributore.
- Non utilizzare raccordi conici su filetti cilindrici.
- Per pulire il distributore, prima della verniciatura, non utilizzare diluenti/solventi o qualsiasi prodotto che possa intaccare le parti in gomma.

### NOTES FOR DIRECTIONAL CONTROL VALVES ASSEMBLY

- *The valve must always and perfectly rest on a 180° degree flat surface.*
- *Do not tamper the tie rod nuts so they might impair the standard working of the valve.*
- *No conical nipples with JIC thread must be used.*
- *Before painting the control valve, do not use diluent or any products that could damage rubber parts.*

## CARATTERISTICHE TECNICHE TECHNICAL CHARACTERISTICS

	Q30	GVS50	Q80	Q130
<b>Numero massimo di elementi</b> <i>Working sections maximum</i>	10	10	10	10
<b>Limiti temperatura olio</b> <i>Oil temperature range</i>	-30 ÷ 80 °C			
<b>Temperatura olio consigliata</b> <i>Recommended oil temperature</i>	30° ÷ 60 °C			
<b>Filtraggio consigliato</b> <i>Recommended filtration</i>	26/23µm ISO DIS 4406			
<b>Fluido</b> <i>Hidraulic fluid</i>	Olio minerale <i>Mineral oil</i>			
<b>Viscosità</b> <i>Viscosity</i>	10 ÷ 400 mm <sup>2</sup> /s			

<b>Massa [Kg]</b> <i>Weight (lbs)</i>	<b>1</b>	Elemento + fiancata d'ingresso + fiancata di scarico <i>Working section + inlet + outlet section</i>	4.2 (9.3)	4.2 (9.3)	8.1 (17.9)	16.6 (36.6)
	<b>2</b>	Elementi + fiancata d'ingresso + fiancata di scarico <i>Working sections + inlet + outlet section</i>	6.2 (13.7)	6.1 (13.5)	11.9 (26.2)	22.4 (49.4)
	<b>3</b>	Elementi + fiancata d'ingresso + fiancata di scarico <i>Working sections + inlet + outlet section</i>	8.1 (17.9)	8.0 (17.6)	15.8 (34.8)	28.2 (62.2)
	<b>4</b>	Elementi + fiancata d'ingresso + fiancata di scarico <i>Working sections + inlet + outlet section</i>	10.1 (22.3)	9.9 (21.8)	19.7 (43.4)	34.1 (75.2)
	<b>5</b>	Elementi + fiancata d'ingresso + fiancata di scarico <i>Working sections + inlet + outlet section</i>	12 (26.5)	11.8 (26.0)	23.5 (51.8)	39.9 (88.0)
	<b>6</b>	Elementi + fiancata d'ingresso + fiancata di scarico <i>Working sections + inlet + outlet section</i>	14 (30.9)	13.7 (30.2)	27.4 (60.4)	45.7 (100.8)
	<b>7</b>	Elementi + fiancata d'ingresso + fiancata di scarico <i>Working sections + inlet + outlet section</i>	15.9 (35.1)	15.6 (34.4)	31.2 (68.8)	51.6 (113.8)
	<b>8</b>	Elementi + fiancata d'ingresso + fiancata di scarico <i>Working sections + inlet + outlet section</i>	17.9 (39.5)	17.5 (38.6)	35 (77.2)	57.4 (126.6)
	<b>9</b>	Elementi + fiancata d'ingresso + fiancata di scarico <i>Working sections + inlet + outlet section</i>	19.8 (43.7)	19.4 (42.8)	38.9 (85.8)	63.2 (139.4)
	<b>10</b>	Elementi + fiancata d'ingresso + fiancata di scarico <i>Working sections + inlet + outlet section</i>	21.8 (48.1)	21.3 (47.0)	42.7 (94.2)	69 (152.1)
		Elemento aggiuntivo <i>Additional section</i>	2.0 (4.4)	1.9 (4.2)	3.9 (8.6)	5.9 (13.6)

<b>Pressioni massime di lavoro [bar]</b> <i>Max working pressure (PSI)</i>	da 1 a 3 elementi <i>from 1 up to 3 working sections</i>	375 (5438)	375 (5438)	350 (5075)	375 (5438)
	da 4 a 6 elementi <i>from 4 up to 6 working sections</i>	350 (5075)	350 (5075)	320 (4640)	350 (5075)
	da 7 a 10 elementi <i>from 7 up to 10 working sections</i>	325 (4713)	325 (4713)	300 (4350)	325 (4713)
<b>Pressione massima sullo scarico [bar]</b> <i>Max back pressure (PSI)</i>		25 (363)			



## ESEMPIO DI ORDINAZIONE IN CODICE ORDERING CODE EXAMPLE

Tipo Type	Fiancata d'ingresso Inlet section			Sezione di lavoro e/o elemento intermedio Working section and/or intermediate section								Fiancata di scarico o ingresso suppl. Outlet section or additional inlet section	Note aggiuntive Additional notes		
Q30	F7S	R250	MSE	E50	R250	2x	103	A1	M1	V30	R250	V01	F3D	12V	2E+1
1	2	3	4	5	6		7	8	9	10	11	12	13	16	17

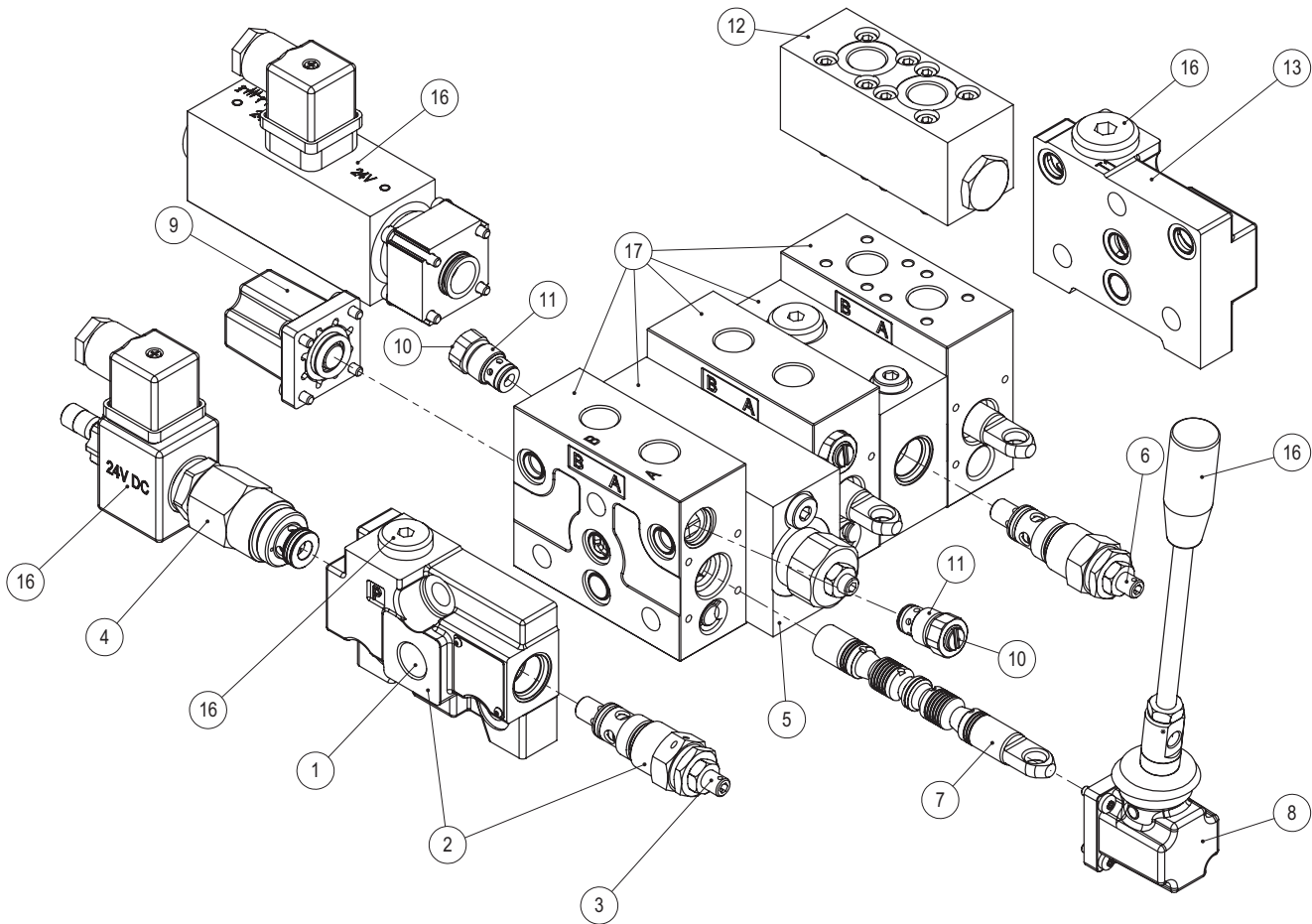

### Tipo

#### 1 - Tipo

#### Q30, GSV50, Q80, Q130

Indica il tipo di distributore; le caratteristiche dimensionali sono riportate da pag. B-6 a pag. B-15

### Type

#### 1 - Type

#### Q30, GSV50, Q80, Q130

Indicates model valve, characteristics and dimensions found on page B-6 to page B-15.

### Fiancata d'ingresso

#### 2 - Tipo fiancata d'ingresso (pag. B-16)

#### 3 - Tipo molla e taratura valvola (pag. B-16)

Dove è presente la valvola VLP (fiancate F7S), deve essere specificato il tipo di molla (**B**, **N** o **R**) e la sua pressione di taratura; se quest'ultima viene omessa la valvola verrà montata la molla N tarata a 150 bar.

#### 4 - Valvole aggiuntive alla fiancata di ingresso (pag. B-17).

### Inlet section

#### 2 - Inlet section type (page B-16)

#### 3 - Type of spring and valve setting (page B-16)

If valve VLP is installed (inlet section F7S), specify the type of spring (**B**, **N** or **R**) and its pressure setting. If omitted spring N with a 150 bar setting will be installed.

#### 4 - Additional valves on the inlet section (page B-17)

## ESEMPIO DI ORDINAZIONE IN CODICE ORDERING CODE EXAMPLE

### Sezione di lavoro e/o elemento intermedio

**5 - Elemento intermedio** (pag. B-16)

**6 - Tipo molla e taratura valvola** (pag. B-16)

Dove è presente la valvola VLP (elementi intermedi E50, E53), deve essere specificato il tipo di molla (**B, N o R**) e la sua pressione di taratura; se quest'ultima viene omessa verrà messa la molla N tarata a **150 bar**.

**N.B.** I campi da 7 a 13 sono da ripetere per ogni sezione. Nel caso in cui due sezioni contigue siano identiche, è sufficiente descriverne solo una antepoendo 2x al campo 7. Il numero massimo complessivo di sezioni di lavoro è indicato a pag. G3.

**7 - Tipo cursore** (pag. B-18)

**8 - Tipo di comando** (pag. B-23, B-27)

**9 - Tipo posizionario** (pag. B-30)

**10 - Tipo valvole a cartuccia** (pag. B-56)

**11 - Tipo molla e taratura valvola** (pag. B-57)

Specificare il tipo di molla e la sua pressione di taratura; se quest'ultima viene omessa, verrà messa la molla N a 120 bar.

**12 - Tipo valvole a pannello** (pag. B-58)

### Fiancata di scarico o ingresso supplementare

**13 - Tipo fiancata di scarico** (pag. B-60)

**13 - Ingresso supplementare** (pag. B-62)

Gli ingressi supplementari, dotati di due ingressi laterali e uno scarico centrale, possono essere utilizzati in sostituzione della fiancata di scarico utilizzando come scarico l'elemento intermedio **E51** (vedi par. 5, pag. B-16).

**14 - Tipo molla e taratura valvola** (pag. B-62)

Dove è presente la valvola VLP, deve essere specificato il tipo di molla (**B, N o R**) e la sua pressione di taratura; se quest'ultima viene omessa verrà messa la molla N tarata a **150 bar**.

**15 - Valvole aggiuntive alla fiancata** (pag. B-63)

### Note aggiuntive

**16 - Note aggiuntive** (pag. B-64)

**17 - Numero sezioni di lavoro**

Specificare il numero delle sezioni di lavoro (es. 2E) e il numero degli elementi intermedi (es. +1) utilizzati tenendo sempre in considerazione che la somma dei due non potrà superare il limite massimo di 10.

### Working section and/or Intermediate section

**5 - Intermediate section** (page B-16)

**6 - Type of spring and valve setting** (page B-16)

If VLP valve is installed (intermediate section E50 and E53), specify the type of spring (**B, N or R**) and its pressure setting. If omitted spring N with a **150 bar** setting will be installed.

**N.B.** Fields 7 to 13 must be repeated for each section. If two adjacent sections are identical, just describe one and put 2x before field 4.

The maximum overall number of working sections is indicated on page G3.

**7 - Spool type** (page B-18)

**8 - Control type** (page B-23, B-27)

**9 - Positioner type** (page B-30)

**10 - Type of built-in cartridge valves** (page B-56)

**11 - Type of spring and valve setting** (page B-57)

Specify the type of spring and its pressure setting. If omitted, spring N with a 120 bar setting will be installed.

**12 - Type of panel valves** (page B-58)

### Outlet section or additional inlet section

**13 - Outlet section type** (page B-60)

**13 - Additional inlet** (page B-62)

The additional inlet sections, fitted with two lateral inlets and with a central outlet can be used as a replacement of the outlet section by using the intermediate element **E51** (see par. 5, page B-16) as relief.

**14 - Type of spring and valve setting** (page B-62)

If VLP valve is installed, specify the type of spring (**B, N or R**) and its pressure setting. If omitted, spring N with a **150 bar** setting will be installed.

**15 - Valvole aggiuntive alla fiancata** (page B-63)

### Additional notes

**16 - Additional notes** (page B-64)

**17 - Number of working sections**

Specify the number of working sections (for ex. 2E) and the number of intermediate elements (for ex. +1) used, always taking into account that the sum of the two will not have to exceed the maximum limit of 10.

# Q30

## DISTRIBUTORI COMPONIBILI SECTIONAL DIRECTIONAL CONTROL VALVES

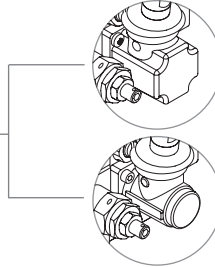
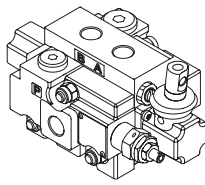

(Standard)  
Comando e posizionate in plastica  
Control and positionner plastic

**S**  
Comando e posizionate in Alluminio  
Control and positionner Aluminium

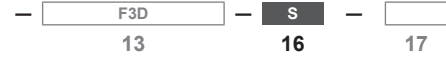

Fori di fissaggio / Mounting holes

L	F
<b>64</b> <b>(2.520)</b>	M6 per fori fissaggio attacchi metrici e GAS M6 mounting holes for metric and GAS ports
<b>56</b> <b>(2.205)</b>	3/8" - 24 UNF per fori fissaggio attacchi SAE 3/8" - 24 UNF mounting holes for SAE ports

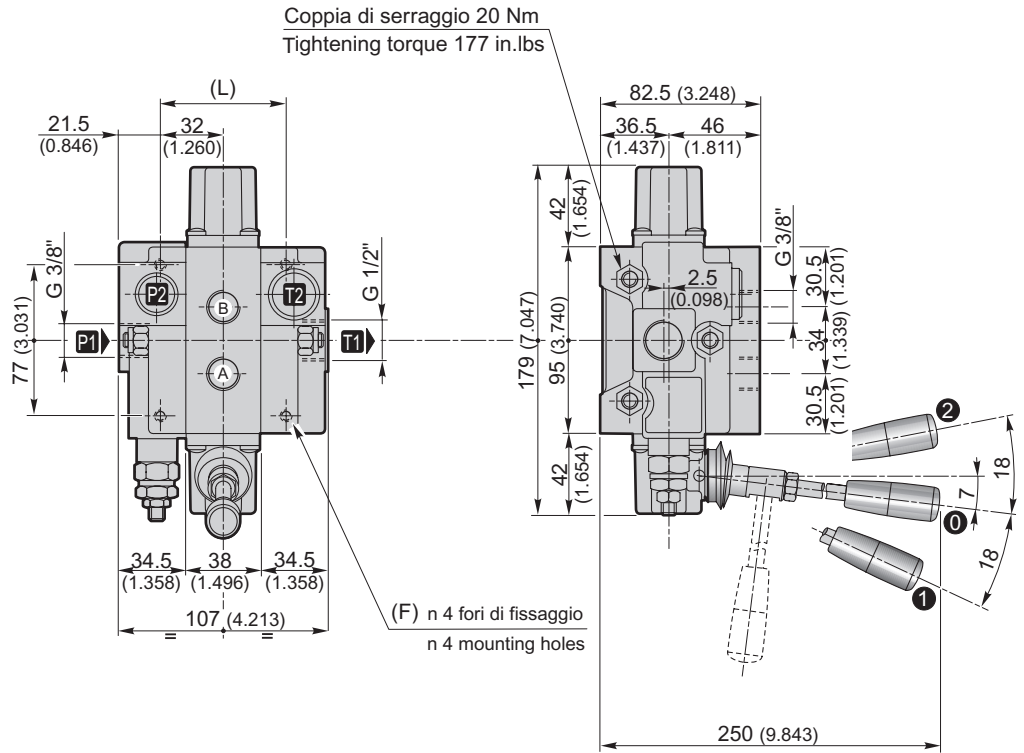

Filettature disponibili / Available ports

Bocche Ports	BSP (standard)	SAE
<b>P1</b>	G 3/8"	3/4" - 16UNF (SAE 8)
<b>P2</b>	G 3/8"	3/4" - 16UNF (SAE 8)
<b>A-B</b>	G 3/8"	9/16" - 18UNF (SAE 6)
<b>T1</b>	G 1/2"	7/8" - 14UNF (SAE 10)
<b>T2</b>	G 1/2"	3/4" - 16UNF (SAE 8)

Tappo per carry-over (su uscita T1)  
Carry-over plug (on T1 port)

	T1	
	<b>X</b>	G 1/2"
	<b>X</b>	G 3/8" - G 1/2"
	<b>T1</b>	7/8"-14UNF (SAE 10)
	<b>X</b>	3/4" - 16UNF (SAE 8)

# Q30

## DISTRIBUTORI COMPONIBILI SECTIONAL DIRECTIONAL CONTROL VALVES

**Perdite di carico con il cursore in posizione neutra**  
( $\Delta p$  in funzione del numero di sezioni attraversate)  
**Pressure drop with spool in neutral position**  
( $\Delta p$  depending on the number of the crossed sections)

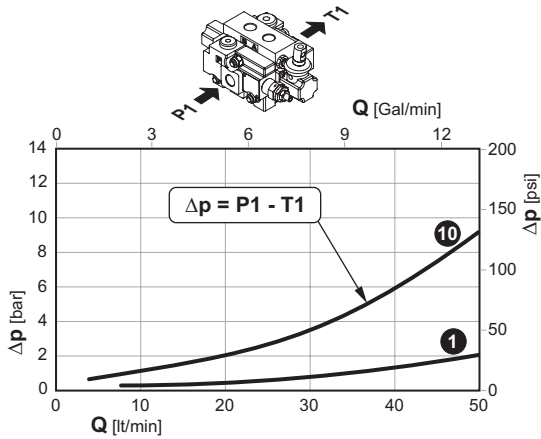

**Perdite di carico con il cursore in posizione di lavoro**  
( $\Delta p$  in funzione del numero di sezioni attraversate)  
**Pressure drop with spool in working position**  
( $\Delta p$  depending on the number of the crossed sections)

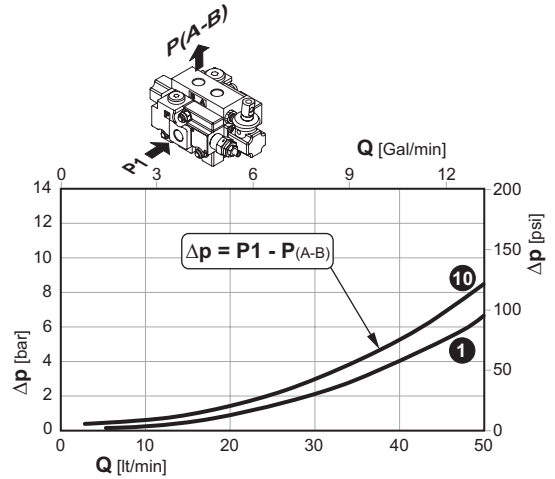

**Perdite di carico con il cursore in posizione di lavoro**  
( $\Delta p$  in funzione del numero di sezioni attraversate)  
**Pressure drop with spool in working position**  
( $\Delta p$  depending on the number of the crossed sections)

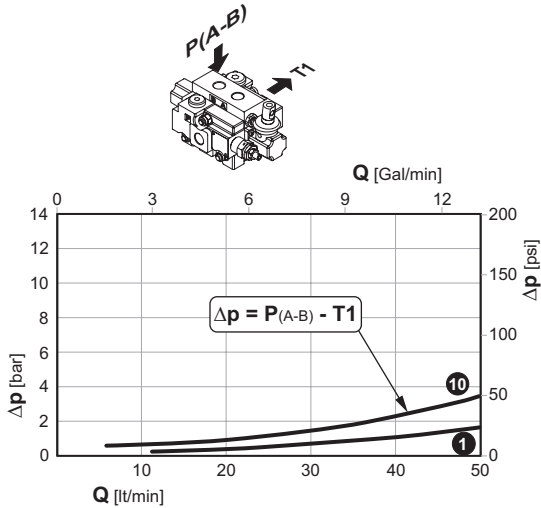

**Perdite di carico tra due elementi in serie**  
**Pressure drop through two sections connected in series**

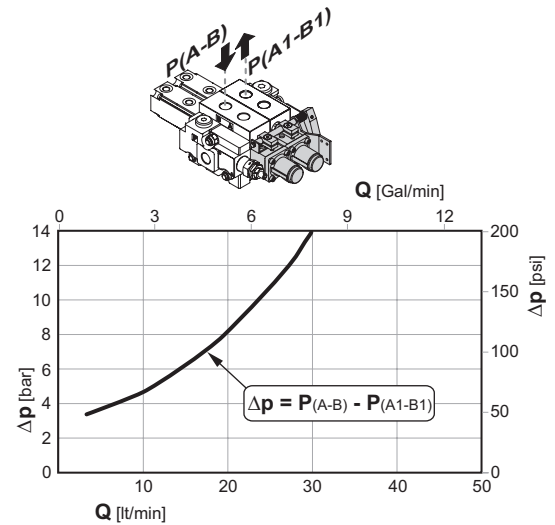

1 10 Sezioni / Sections

### Curve di progressività Spool metering

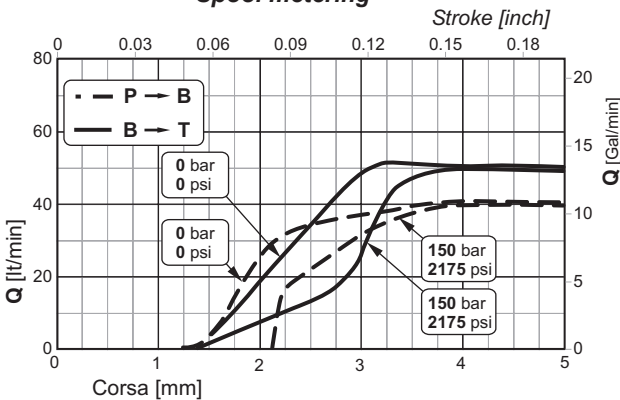

### Trafilamenti sul cursore Spool leakage

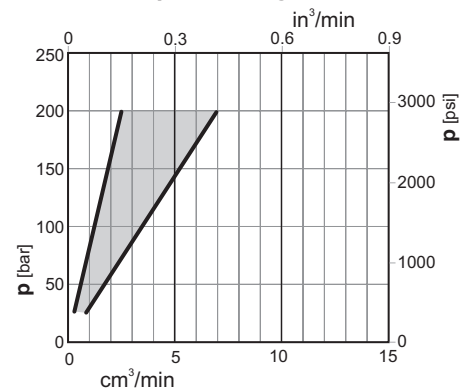

N.B. Le curve sono ricavate con cursore 103 / NOTE. Performance curves measured using spool 103 type.

# GSV50

## DISTRIBUTORI COMPONIBILI SECTIONAL DIRECTIONAL CONTROL VALVES

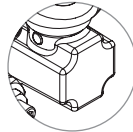
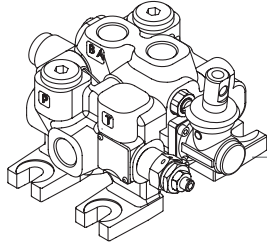

(Standard)  
Comando e posizionatore in plastica  
*Control and positioner plastic*

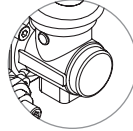

**S**  
Comando e posizionatore in Alluminio  
*Control and positioner Aluminium*

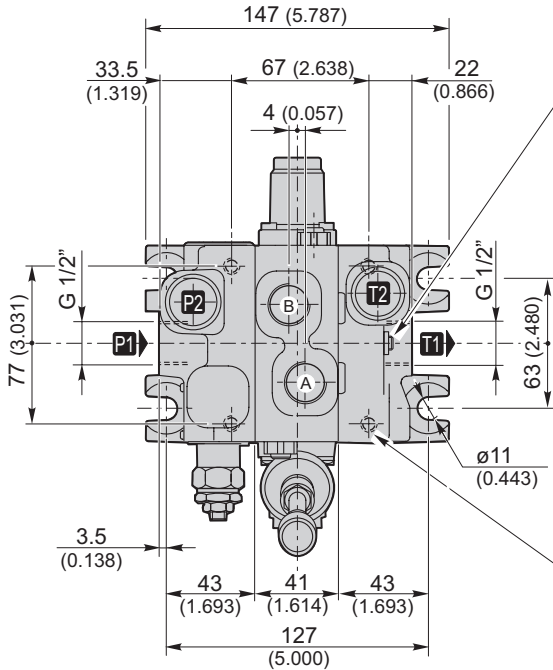
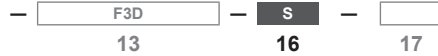

Coppia di serraggio 20 Nm  
*Tightening torque 177 in lbs*

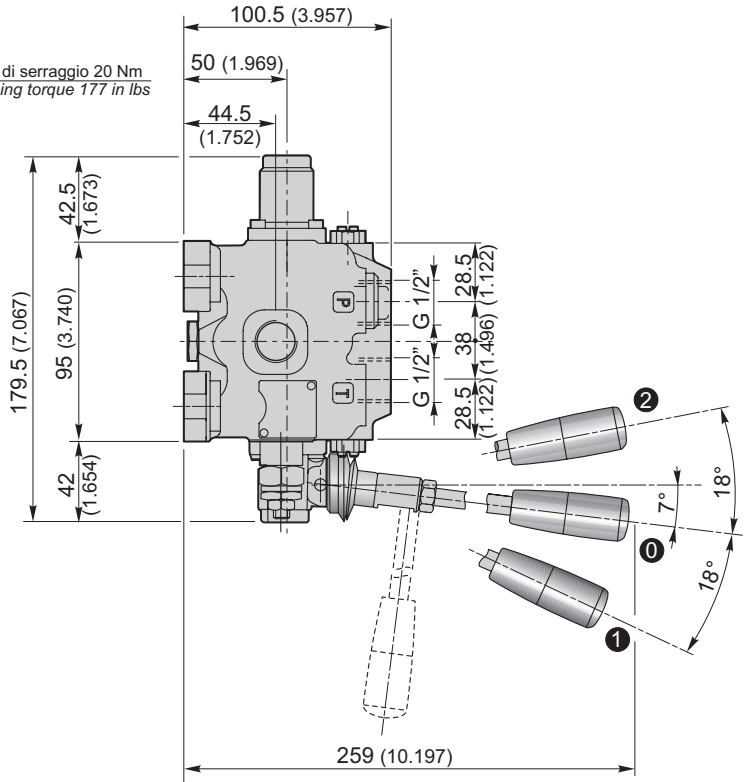

n°4 fori di fissaggio: M8 per attacchi metrici e Gas  
3/8"-24UNF per attacchi SAE  
 n°4 mounting holes: M8 for metric and Gas ports  
3/8"-24UNF for SAE ports

ⓘ E' possibile avere lo scarico T3 nella fiancata di ingresso  
*It's possible add Tank porting T3 in the inlet section*



Filettature disponibili / Available ports

Bocche Ports	BSP (standard)	SAE
P1	G 1/2"	3/4" - 16UNF (SAE 8)
P2	G 1/2"	3/4" - 16UNF (SAE 8)
A-B	G 1/2"	3/4" - 16UNF (SAE 8)
T1	G 1/2"	7/8" - 14UNF (SAE 10)
T2	G 1/2"	3/4" - 16UNF (SAE 8)
T3	G 1/2"	3/4" - 16UNF (SAE 8)

Tappo per carry-over (su uscita T1)  
*Carry-over plug (on T1 port)*

Port	Thread
T1	G 1/2"
X	G 3/8" - G 1/2"
T1	7/8" - 14UNF (SAE 10)
X	3/4" - 16UNF (SAE 8) 7/8" - 14UNF (SAE 10)

# GSV50

## DISTRIBUTORI COMPONIBILI SECTIONAL DIRECTIONAL CONTROL VALVES

**Perdite di carico con il cursore in posizione neutra**  
( $\Delta p$  in funzione del numero di sezioni attraversate)

**Pressure drop with spool in neutral position**  
( $\Delta p$  depending on the number of the crossed sections)

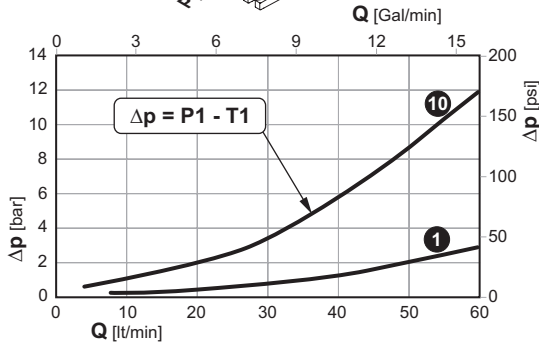
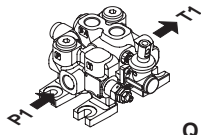

**Perdite di carico con il cursore in posizione di lavoro**  
( $\Delta p$  in funzione del numero di sezioni attraversate)

**Pressure drop with spool in working position**  
( $\Delta p$  depending on the number of the crossed sections)

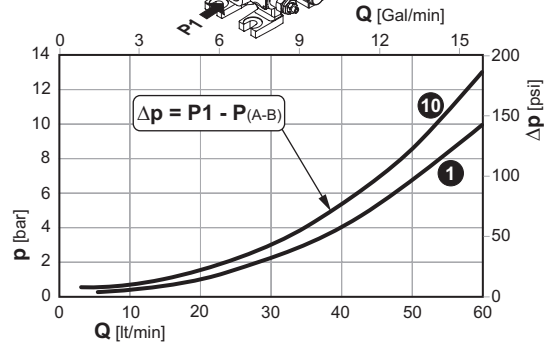
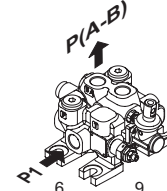

**Perdite di carico con il cursore in posizione di lavoro**  
( $\Delta p$  in funzione del numero di sezioni attraversate)

**Pressure drop with spool in working position**  
( $\Delta p$  depending on the number of the crossed sections)

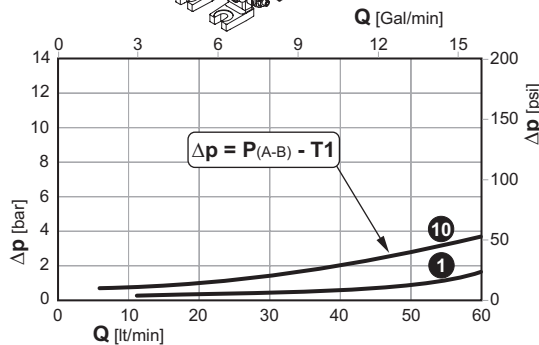
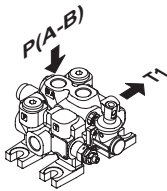

**Perdite di carico tra due elementi in serie**

**Pressure drop through two sections connected in series**

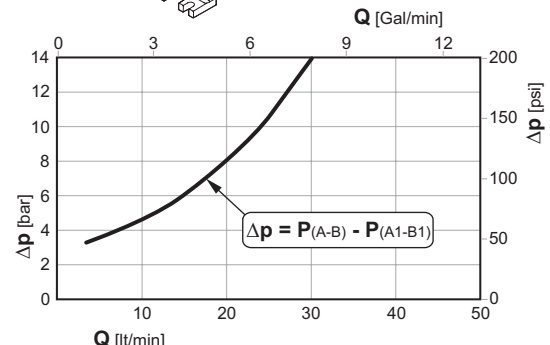
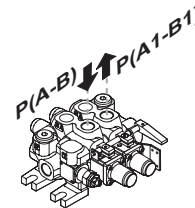

1 10 Sezioni / Sections

### Curve di progressività Spool metering

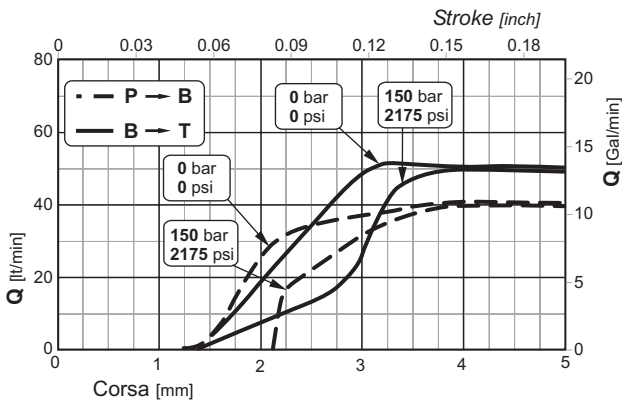

### Trafilamenti sul cursore Spool leakage

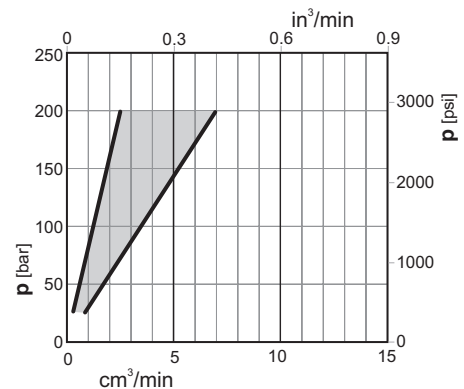

N.B. Le curve sono ricavate con cursore 103 / NOTE. Performance curves measured using spool 103 type.

# Q80

## DISTRIBUTORI COMPONIBILI SECTIONAL DIRECTIONAL CONTROL VALVES

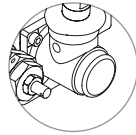
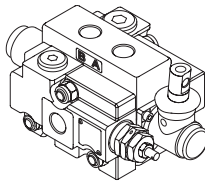

(Standard)  
Comando e posizionatore in Alluminio  
Control and positioner Aluminium

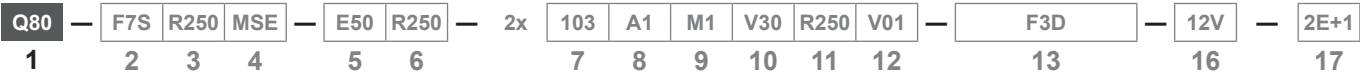
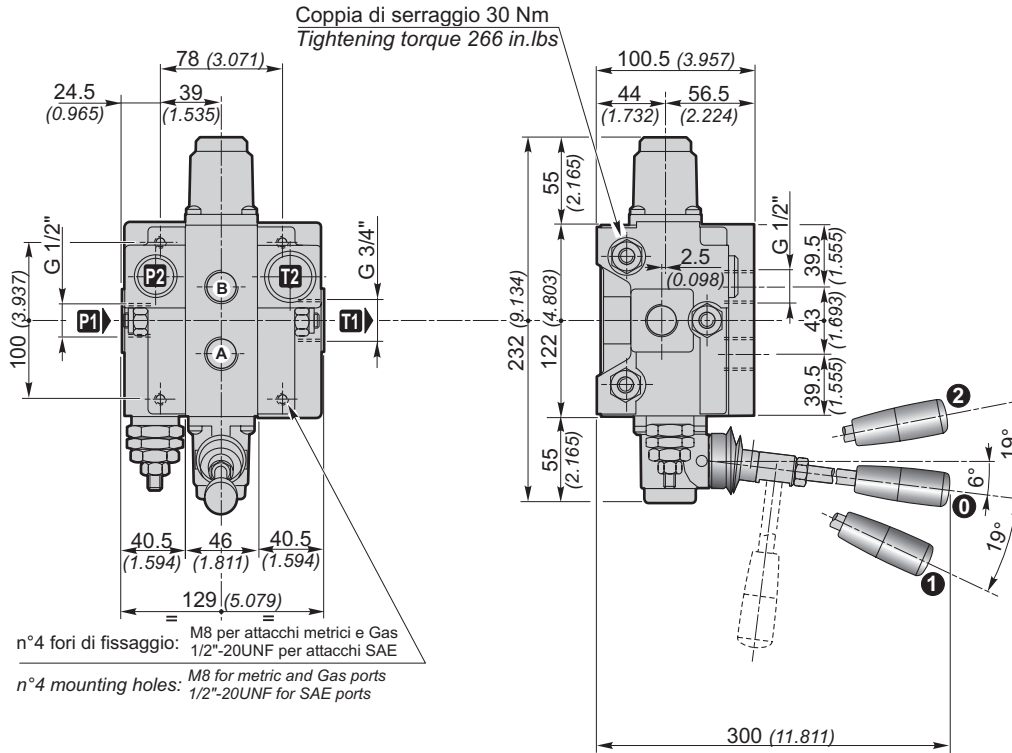

Filettature disponibili / Available ports

Bocche Ports	BSP (standard)	BSP G 3/4"	SAE
P1	G 1/2"	G 3/4"	7/8" - 14UNF (SAE 10)
P2	G 1/2"	G 3/4"	7/8" - 14UNF (SAE 10)
A-B	G 1/2"	G 3/4"	3/4" - 16UNF (SAE 8)
T1	G 3/4"	G 3/4"	1" 1/16" - 12UN (SAE 12)
T2	G 3/4"	G 3/4"	7/8" - 14UNF (SAE 10)

Tappo per carry-over (su uscita T1)  
Carry-over plug (on T1 port)

T1	G 3/4"
X	G 1/2" - G 3/4"
T1	1" 1/16" - 12UN (SAE 12)
X	7/8" - 14UNF (SAE 10)
T1	G 3/4"
X	G 3/4"

Dimensioni in / Dimensions in: mm (inch)

# Q80

## DISTRIBUTORI COMPONIBILI SECTIONAL DIRECTIONAL CONTROL VALVES

**Perdite di carico con il cursore in posizione neutra**  
( $\Delta p$  in funzione del numero di sezioni attraversate)

**Pressure drop with spool in neutral position**  
( $\Delta p$  depending on the number of the crossed sections)

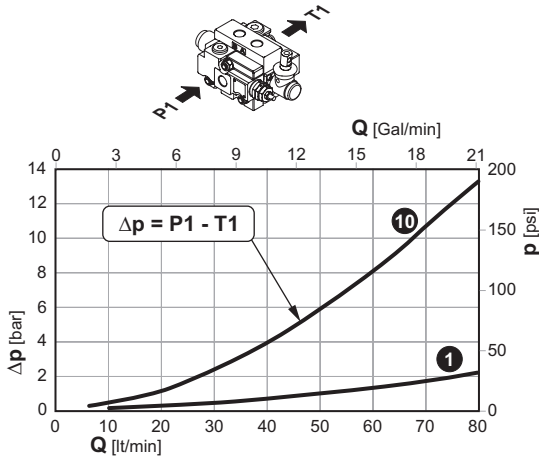

**Perdite di carico con il cursore in posizione di lavoro**  
( $\Delta p$  in funzione del numero di sezioni attraversate)

**Pressure drop with spool in working position**  
( $\Delta p$  depending on the number of the crossed sections)

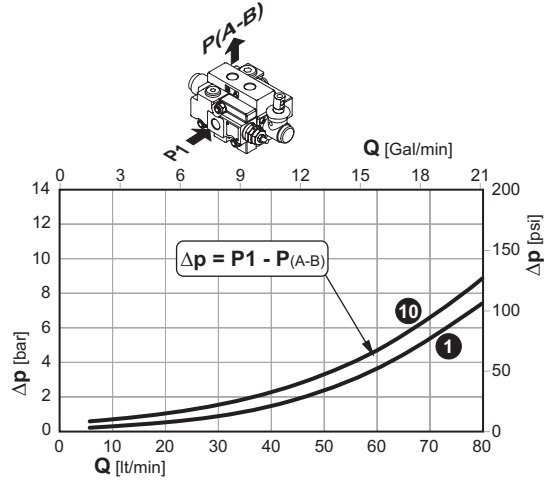

**Perdite di carico con il cursore in posizione di lavoro**  
( $\Delta p$  in funzione del numero di sezioni attraversate)

**Pressure drop with spool in working position**  
( $\Delta p$  depending on the number of the crossed sections)

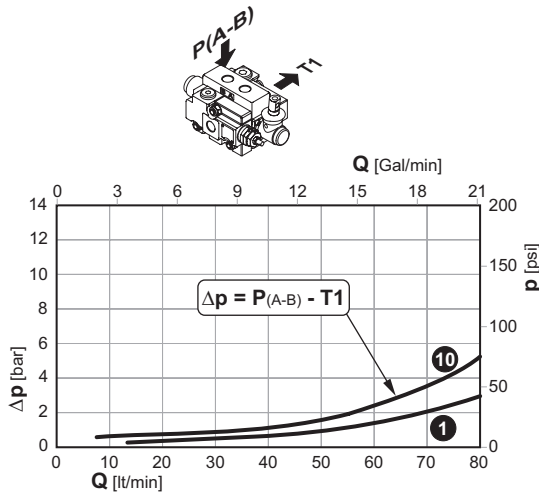

**Perdite di carico tra due elementi in serie**

**Pressure drop through two sections connected in series**

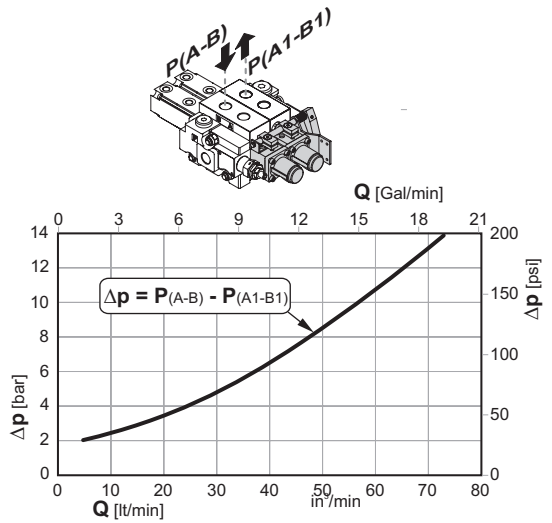

1 10 Sezioni / Sections

### Curve di progressività Spool metering

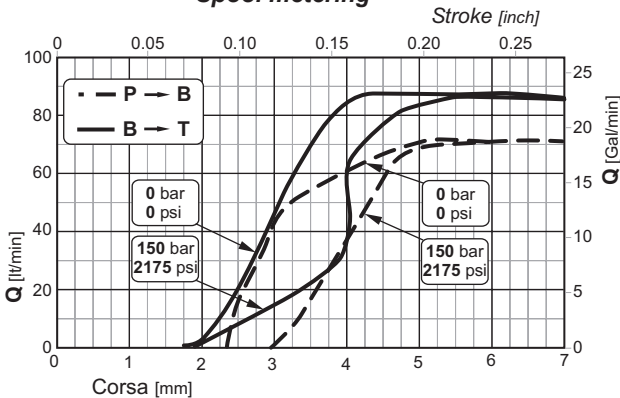

### Trafilamenti sul cursore Spool leakage

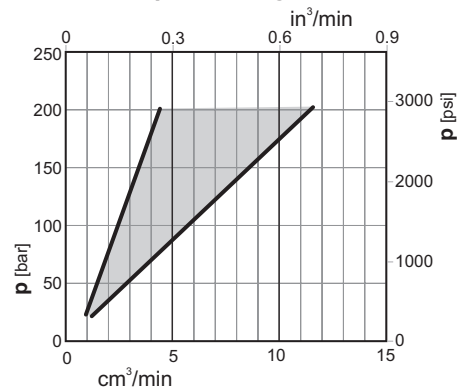

N.B. Le curve sono ricavate con cursore 103 / NOTE. Performance curves measured using spool 103 type.



# Q130

## DISTRIBUTORI COMPONIBILI SECTIONAL DIRECTIONAL CONTROL VALVES

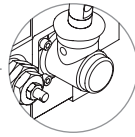
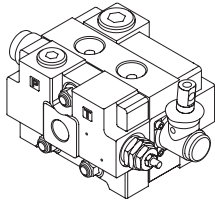

(Standard)  
Comando e posizionatore in Alluminio  
Control and positioner Aluminium

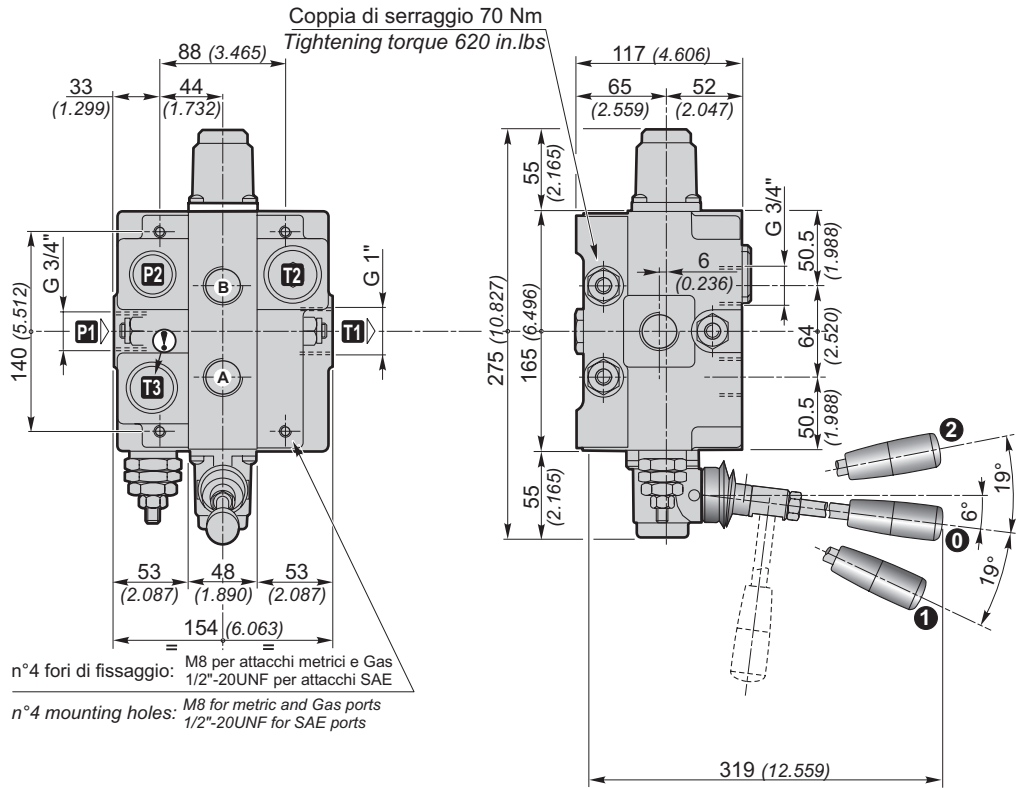

ⓘ E' possibile avere lo scarico T3 nella fiancata di ingresso  
It's possible add Tank porting T3 in the inlet section

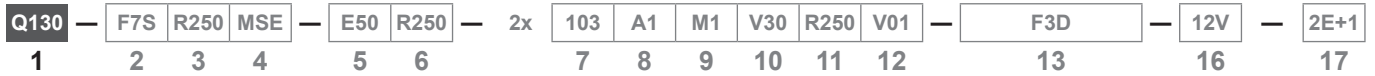

Filettature disponibili / Available ports

Bocche Ports	BSP (standard)	BSP G 1"	SAE (standard)	SAE
P1	G 3/4"	G 1"	1" 5/16 - 12UN (SAE 16)	1" 5/16 - 12UN (SAE 16)
P2	G 3/4"	G 1"	1" 5/16 - 12UN (SAE 16)	1" 5/16 - 12UN (SAE 16)
A-B	G 3/4"	G 1"	1" 1/16 - 12UN (SAE 12)	1" 5/16 - 12UN (SAE 16)
T1	G 1"	G 1"	1" 5/16 - 12UN (SAE 16)	1" 5/16 - 12UN (SAE 16)
T2	G 1"	G 1"	1" 5/16 - 12UN (SAE 16)	1" 5/16 - 12UN (SAE 16)
T3	G 1"	G 1"	1" 5/16 - 12UN (SAE 16)	1" 5/16 - 12UN (SAE 16)

Tappo per carry-over (su uscita T1)  
Carry-over plug (on T1 port)

T1	G 1"
X	G 3/4" - G 1"
T1	G 1"
X	G 1"
T1	1" 5/16-12 UN (SAE 16)
X	1" 1/16-12 UN (SAE 12)

# Q130

## DISTRIBUTORI COMPONIBILI SECTIONAL DIRECTIONAL CONTROL VALVES

**Perdite di carico con il cursore in posizione neutra**  
( $\Delta p$  in funzione del numero di sezioni attraversate)  
**Pressure drop with spool in neutral position**  
( $\Delta p$  depending on the number of the crossed sections)

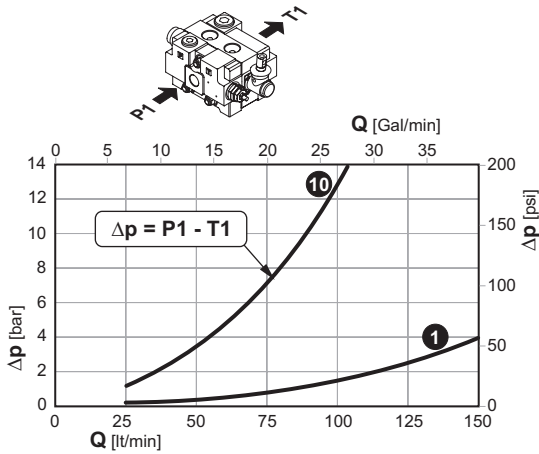

**Perdite di carico con il cursore in posizione di lavoro**  
( $\Delta p$  in funzione del numero di sezioni attraversate)  
**Pressure drop with spool in working position**  
( $\Delta p$  depending on the number of the crossed sections)

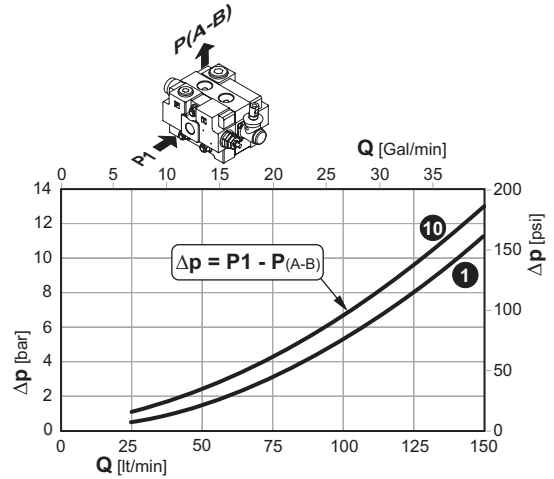

**Perdite di carico con il cursore in posizione di lavoro**  
( $\Delta p$  in funzione del numero di sezioni attraversate)  
**Pressure drop with spool in working position**  
( $\Delta p$  depending on the number of the crossed sections)

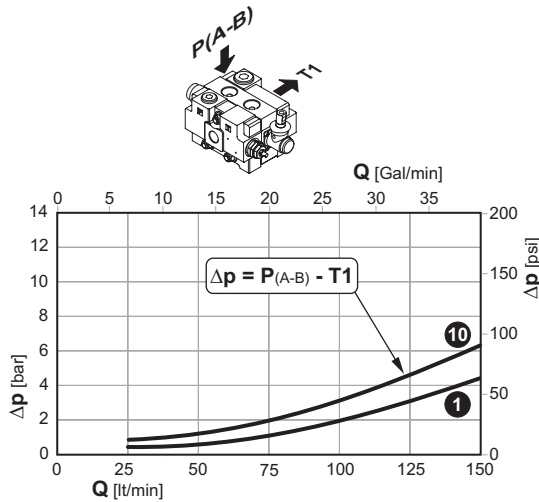

**Perdite di carico tra due elementi in serie**  
**Pressure drop through two sections connected in series**

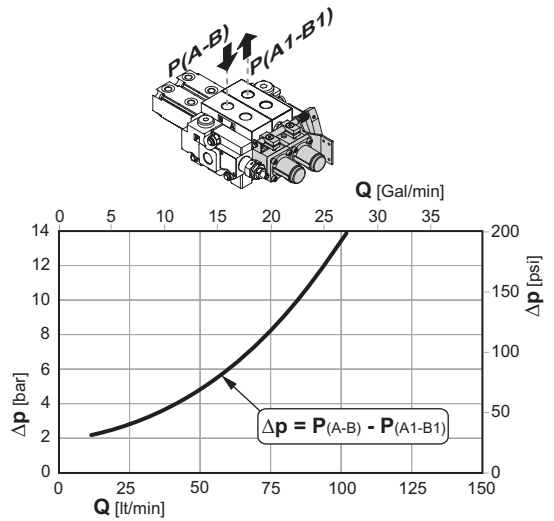

1 10 Sezioni / Sections

### Curve di progressività Spool metering

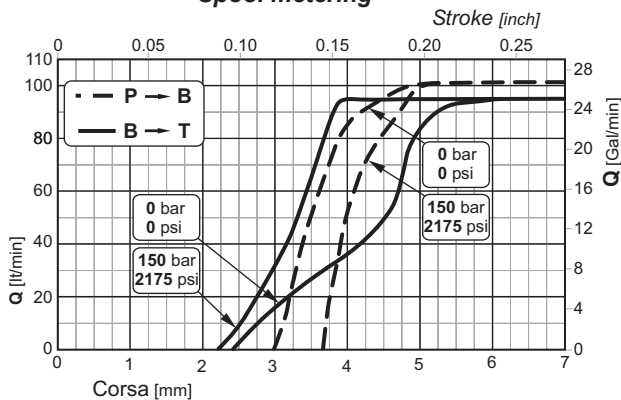

### Trafilamenti sul cursore Spool leakage

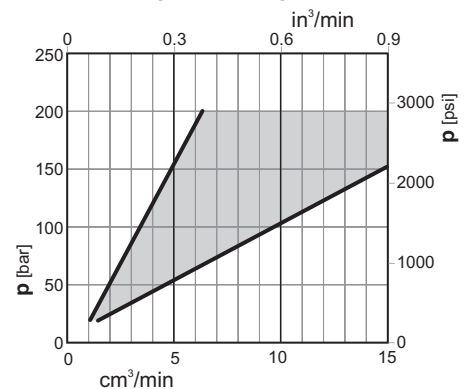

N.B. Le curve sono ricavate con cursore 103 / NOTE. Performance curves measured using spool 103 type.

Fiancata d'ingresso

Inlet section

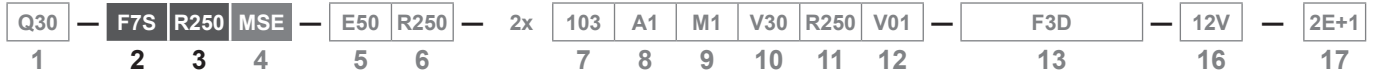

2 - Tipo fiancata d'ingresso / Inlet section type

		Q30	GSV50	Q80	Q130
<b>F7S</b>	Collettore di entrata sinistro con valvola limitatrice di pressione VLP <i>Left inlet section with relief valve VLP</i>	•	•	•	•
<b>F17S</b>	Collettore di entrata sinistro con valvola limitatrice di pressione VLP e attacco T3 <i>Left inlet section with relief valve VLP and T3 porting</i>		•		•
<b>F7SP</b>	Collettore di entrata sinistro con valvola limitatrice di pressione pilotata <i>Inlet section with pilot relief valve VLPP</i>				•
<b>F17SP</b>	Collettore di entrata sinistro con valvola limitatrice di pressione pilotata e attacco T3 <i>Inlet section with pilot relief valve VLPP and T3 porting</i>				•
<b>F8S</b>	Collettore di entrata sinistro senza valvole <i>Left inlet section without valves</i>	•	•	•	•
<b>F18S</b>	Collettore di entrata sinistro senza valvole e attacco T3 <i>Left inlet section without valves and T3 porting</i>		•		•

**F7S**

**F17S**

Collettore di entrata con valvola limitatrice di pressione VLP  
*Inlet section with relief valve VLP*

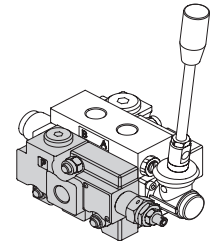
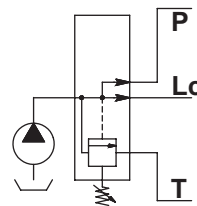

**F7SP**

**F17SP**

Collettore di entrata con valvola limitatrice di pressione pilotata VLPP  
*Inlet sections with piloted relief valve VLPP*

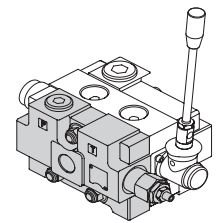
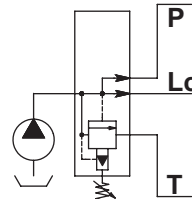

3 - Tipo molla e taratura valvola

Dove è presente la valvola VLP (fiancate F7S), deve essere specificato il tipo di molla (**B, N o R**) e la sua pressione di taratura; **se quest'ultima viene omessa, verrà messa la molla N tarata a 150 bar**. Dove è presente la VLPP indicare solo la pressione di taratura.

3 - Type of spring and valve setting

If valve VLP is installed (inlet section F7S), specify the type of spring (**B, N or R**) and its pressure setting. **If omitted, spring N with a 150 bar setting will be installed.** For VLPP valve specify only pressure setting.

		molla bianca <i>white spring</i>	molla nera <i>black spring</i>	molla rossa <i>red spring</i>
<b>R</b>	Tipo di molla per la VLP <i>Type of spring for relief valve</i>	<b>B</b>	<b>N</b>	<b>R</b>
Campi di taratura / <i>Calibration fields</i>				
<b>250</b>	Taratura della VLP <i>VLP Setting</i>	10 ÷ 80 (145 ÷ 1160)	81 ÷ 200 (1175 ÷ 2900)	201 ÷ 380 (2915 ÷ 5510)

**F8S**

**F18S**

Collettore di entrata senza valvole  
*Inlet section without valves*

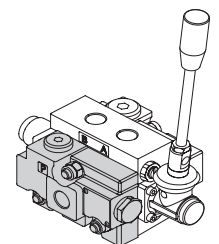
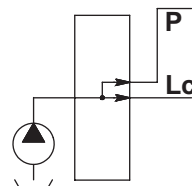

**Fiancata d'ingresso**

**Inlet section**



**4 - Valvole aggiuntive alla fiancata (facoltativo) / Additional valves to the inlet section (optional)**

			Q30	GSV50	Q80	Q130
<b>PMS</b>	Collettore di entrata con predisposizione per valvola di messa a scarico elettrica (indiretta) o idraulica	<i>Inlet section presets for electrical outlet release valve (indirect) or hydraulic</i>	•	•	•	•
<b>MSI</b>	Collettore di entrata con valvola di messa a scarico idraulica	<i>Inlet section with hydraulic outlet release valve</i>	•	•	•	•
<b>MSE</b>	Collettore di entrata con valvola di messa a scarico elettrica (indiretta)	<i>Inlet section with electrical outlet release valve (indirect)</i>	•	•	•	•
<b>VRF</b>	Collettore di entrata con valvola regolatrice di flusso	<i>Inlet section flow regulator valve</i>	•	•	•	•

**PMS**

Collettore di entrata con predisposizione per valvola di messa a scarico elettrica (indiretta) o idraulica  
*Inlet section presets for electrical outlet release valve (indirect) or hydraulic*

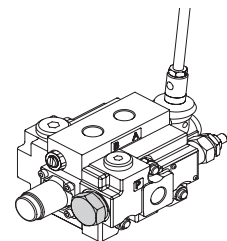
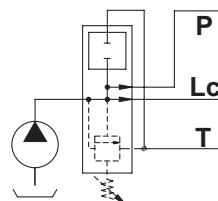

**MSI**

Collettore di entrata con valvola di messa a scarico idraulica  
*Inlet section with hydraulic outlet release valve*

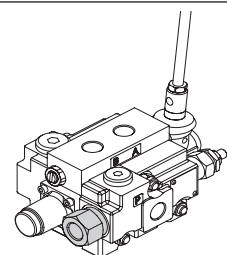
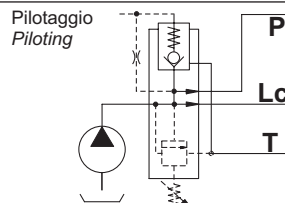

**MSE**

Collettore di entrata con valvola di messa a scarico elettrica (indiretta)  
*Inlet section with electrical outlet release valve (indirect)*

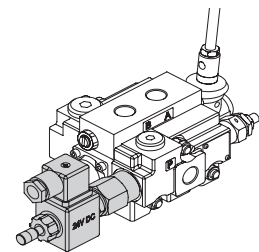
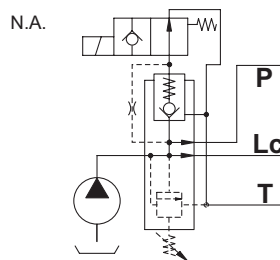

**N.B.**  
 Specificare tensione e schema dell'elettrovalvola  
*Specify voltage and type of the solenoid operated valve*

Tensione Voltage
12 V.DC
24 V.DC

Schema Scheme	
<b>N.C.</b>	Normalmente chiusa <i>Usually closed</i>
<b>N.A.</b>	Normalmente aperta <i>Usually open</i>

**VRF**

Collettore di entrata con valvola regolatrice di flusso  
*Inlet section flow regulator valve*

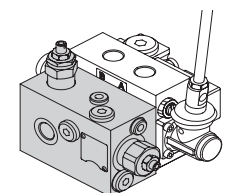
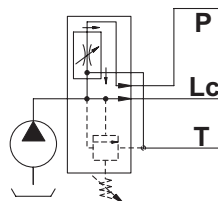

## Sezione di lavoro e/o elemento intermedio

## Working section and/or intermediate section

Q30	F7S	R250	MSE	E50	R250	2x	103	A1	M1	V30	R250	V01	F3D	12V	2E+1
1	2	3	4	5	6		7	8	9	10	11	12	13	16	17

I campi da 7 a 13 sono da ripetere per ogni sezione. Nel caso in cui due sezioni contigue siano identiche, è sufficiente descriverne solo una antepoendo **2x** al campo 7.

**Fields 7 to 13 must be repeated for each section. If two adjacent sections are identical, just describe one and put 2x before field 7.**

## 5 - Elemento intermedio

Questo campo viene omissso se viene utilizzata una sezione di lavoro.

Il numero massimo complessivo di sezioni di lavoro e/o elementi intermedi è 10.

## 5 - Intermediate section

This field is omitted if a working section is used.

The maximum overall number of working sections and/or intermediate elements is 10.

			Q30	GSV50	Q80	Q130
E50	Elemento intermedio con VLP	Intermediate section with relief valve	•	•	•	•
E51	Collettore di uscita intermedio	Intermediate outlet section	•	•	•	•
E53	Elemento intermedio per entrata 2ª pompa con VLP	Intermediate inlet section for 2nd pump with relief valve	•	•	•	•
E58	Elemento intermedio con divisore di portata 3 vie compensato registrabile con cacciavite (tipo "C") o con volantino (tipo "V")	Intermediate section with 3 way flow divider adjustable and compensated whit screwdriver (type "C") or handweel (type "V")	•	•	•	•
E68	Elemento intermedio con divisore di portata 3 vie compensato registrabile con cacciavite (tipo "C") o con volantino (tipo "V")	Intermediate section with 3 way flow divider adjustable and compensated whit screwdriver (type "C") or handweel (type "V")	•	•	•	•
E62	Elemento intermedio con valvola riduttrice di pressione per pilotaggio comando elettroidraulico	Intermediate section with pressure reducing valve for piloting electro-hydraulic control			•	•
E61	Elemento intermedio di spessoramento	Intermediate spacer element	•	•	•	•

## \* Limitazioni / Limitations

Elemento intermedio Intermediate section	Applicabile con: / Applicable with:			
	Valvole / Valves	Cursore Spool	Comando Control	Posizionatore Positioner
E50	Indicare la molla (B - N - R) e taratura della valvola limitatrice VLP Indicate the spring (B-N_R) and setting of the pressure relief valve VLP	Non serve It is of no use	Non serve It is of no use	Non serve It is of no use
E51	Non serve It is of no use			
E53	Indicare la molla (B - N - R) e taratura della valvola limitatrice VLP Indicate the spring (B-N_R) and setting of the pressure relief valve VLP			
E58				
E68	Non serve It is of no use			
E62				
E61				

## 6 - Tipo molla e taratura valvola

Dove è presente la valvola VLP (fiancate E50 e E53), deve essere specificato il tipo di molla (**B**, **N** o **R**) e la sua pressione di taratura; **se quest'ultima viene omisssa, verrà messa la molla N tarata a 150 bar.**

## 6 - Type of spring and valve setting

**If valve VLP is installed (inlet section E50 and E53), specify the type of spring (B, N or R) and its pressure setting. If omitted, spring N with a 150 bar setting will be installed.**

		molla bianca white spring	molla nera black spring	molla rossa red spring
R	Tipo di molla per la VLP Type of spring for relief valve	B	N	R
		Campi di taratura / Calibration fields bar (psi)		
250	Taratura della VLP VLP Setting	10 ÷ 80 (145 ÷ 1160)	81 ÷ 200 (1175 ÷ 2900)	201 ÷ 380 (2915 ÷ 5510)

Sezione di lavoro e/o elemento intermedio

Working section and/or intermediate section

Q30	F7S	R250	MSE	E50	R250	2x	103	A1	M1	V30	R250	V01	F3D	12V	2E+1
1	2	3	4	5	6		7	8	9	10	11	12	13	16	17

**E50**

Elemento intermedio con VLP  
*Intermediate section with relief valve*

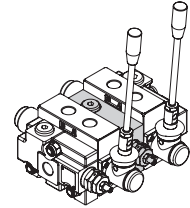
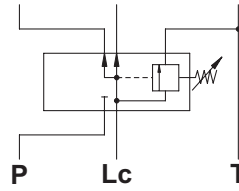

**E51**

Collettore di uscita intermedio  
*Intermediate outlet section*

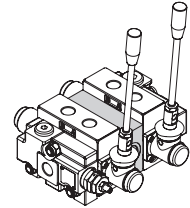
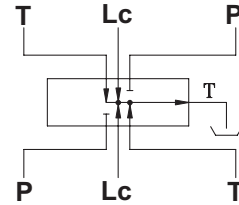

**E53**

Elemento intermedio per  
 entrata 2ª pompa con VLP  
*Intermediate inlet section for  
 2nd pump with relief valve*

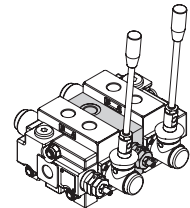
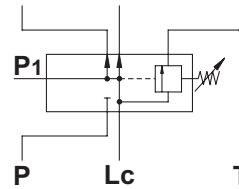

**E58**

Elemento intermedio con divisore di portata 3 vie compensato registrabile  
 con cacciavite (tipo "C") o con volantino (tipo "V"), centro chiuso  
*Intermediate section with 3 way flow divider adjustable and compensated  
 whit screw (type "C") or handwheel (type "V"), through passage closed*

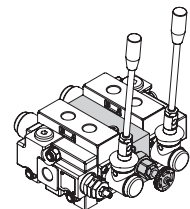
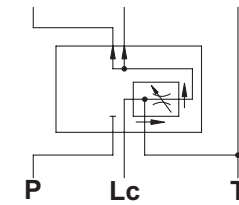

**E68**

Elemento intermedio con divisore di portata 3 vie compensato registrabile  
 con cacciavite (tipo "C") o con volantino (tipo "V"), centro aperto  
*Intermediate section with 3 way flow divider adjustable and compensated  
 whit screw (type "C") or handwheel (type "V"), through passage opened*

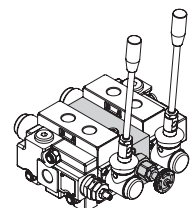
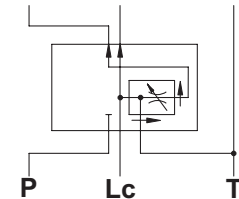

**E62**

Elemento intermedio con valvola riduttrice  
 di pressione per pilotaggio comando elettroidraulico  
*Intermediate section with pressure reducing  
 valve for piloting electro-hydraulic control*

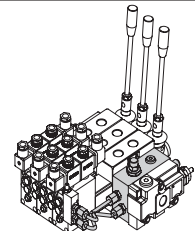
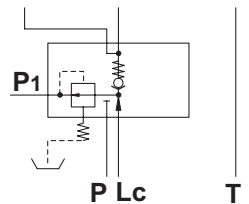

**E61**

Elemento intermedio di spessoramento  
*Intermediate spacer element*

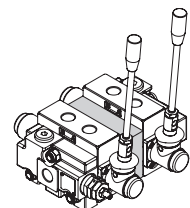
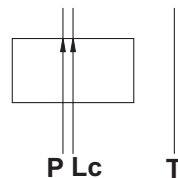

Sezione di lavoro e/o elemento intermedio

Working section and/or intermediate section

Q30	F7S	R250	MSE	E50	R250	2x	103	A1	M1	V30	R250	V01	F3D	12V	2E+1
1	2	3	4	5	6		7	8	9	10	11	12	13	16	17

I campi da 7 a 13 sono da ripetere per ogni sezione. Nel caso in cui due sezioni contigue siano identiche, è sufficiente descriverne solo una antepoendo **2x** al campo 7.

Fields 7 to 13 must be repeated for each section. If two adjacent sections are identical, just describe one and put **2x** before field 7.

7 - Tipo cursore / Spool type

Cursori

Q30	GSV50	Q80	Q130
-----	-------	-----	------

101	Semplice effetto in A	Single acting in A port	•	•	•	•
102	Semplice effetto in B	Single acting in B port	•	•	•	•
103	Doppio effetto, A e B chiusi in posizione 0	Double acting A and B closed in 0 position	•	•	•	•
106	Doppio effetto, passaggi chiusi in posizione 0	Double acting, ports closed in 0 position	•	•	•	•
107	Doppio effetto, A in T e B chiuso in posizione 0	Double acting, A to T and B closed in 0 position	•	•	•	•
108	Doppio effetto, B in T e A chiuso in posizione 0	Double acting, B to T and A closed in 0 position	•	•	•	•
109	Semplice effetto in A, A in T in posizione 0	Single acting in A, A to T in 0 position	•	•	•	•
110	Semplice effetto in B, B in T in posizione 0	Single acting in B, B to T in 0 position	•	•	•	•
111	Doppio effetto, A e B in T in posizione 0	Double acting, A and B to T in 0 position	•	•	•	•
114	Doppio effetto, A e B in T e Lc chiusa in posizione 0	Double acting, A and B to T and through passage closed in 0 position	•	•	•	•
116*	Doppio effetto con 4ª posizione flottante	Double acting with 4th position floating	•	•	•	•
126*	Doppio effetto con 4ª posizione flottante	Double acting with 4th position floating	•	•	•	•

\* Limitazioni / Limitations

Cursore Spools	Applicabile con: / Applicable with:		
	Comando / Control	Posizionatore / Positioner	Valvole / Valves
116	A1-Z1 / A2-Z1 / A4-Z1 / A6-Z1 / A8-Z1	R8	Tutte le valvole a cartuccia e tutte le valvole a pannello All of the cartridge valves and all of the panel valves
126	A1 / A2 / A4 / A5 / A6 / A8 / SL / SLA15 / A15 / A16	R10-Z1	

**101**

Semplice effetto in A  
Single acting in A port

**106**

Doppio effetto, passaggi chiusi in posizione 0  
Double acting, ports closed in 0 position

**102**

Semplice effetto in B  
Single acting in B port

**107**

Doppio effetto, A in T e B chiuso in posizione 0  
Double acting, A to T and B closed in 0 position

**103**

Doppio effetto, A e B chiusi in posizione 0  
Double acting, A and B closed in 0 position

**108**

Doppio effetto, B in T e A chiuso in posizione 0  
Double acting, B to T and A closed in 0 position

Sezione di lavoro e/o elemento intermedio

Working section and/or intermediate section

Q30	F7S	R250	MSE	E50	R250	2x	103	A1	M1	V30	R250	V01	F3D	12V	2E+1
1	2	3	4	5	6		7	8	9	10	11	12	13	16	17

Cursori

109

Semplice effetto in A, A in T in posizione 0  
Single acting in A, A to T in 0 position

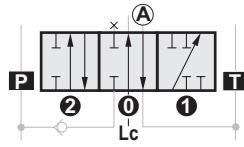

114

Doppio effetto, A e B in T e Lc chiusa in posizione 0  
Double acting, A and B to T and through passage closed in 0 position

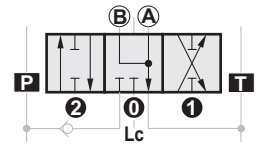

110

Semplice effetto in B, B in T in posizione 0  
Single acting in B, B to T in 0 position

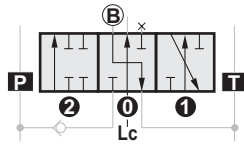

116

Doppio effetto con 4ª posizione flottante  
Double acting with 4th position floating

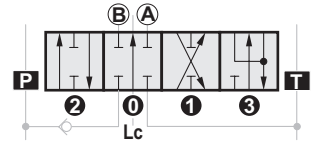

111

Doppio effetto, A e B in T in posizione 0  
Double acting, A and B to T in 0 position

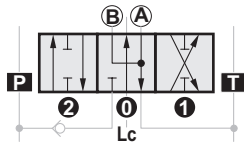

126

Doppio effetto con 4ª posizione flottante  
Double acting with 4th position floating

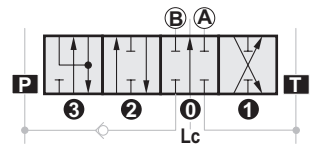

Cursori serie / Serie spools

Q30	GSV50	Q80	Q130
-----	-------	-----	------

403	Doppio effetto SERIE	Double acting SERIE	•	•	•	•
411	Doppio effetto SERIE, A e B in T in pos. 0	Double acting SERIE, A and B to T in 0 position	•	•	•	•

403

Doppio effetto SERIE  
Double acting SERIE

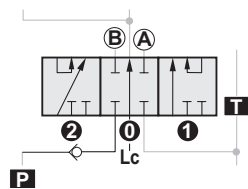

411

Doppio effetto SERIE, A e B in T in pos. 0  
Double acting SERIE, A and B to T in 0 position

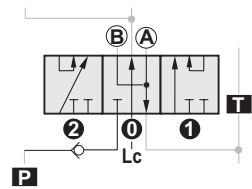



Sezione di lavoro e/o elemento intermedio

Working section and/or intermediate section

Q30	F7S	R250	MSE	E50	R250	2x	103	A1	M1	V30	R250	V01	F3D	12V	2E+1
1	2	3	4	5	6		7	8	9	10	11	12	13	16	17

Cursori singoli / Single spools

Q30	GSV50	Q80	Q130
-----	-------	-----	------

201	Semplice effetto in A	Single acting in A port	•	•	•	•
202	Semplice effetto in B	Single acting in B port	•	•	•	•
203	Doppio effetto	Double acting	•	•	•	•
207	Doppio effetto, A in T e B chiuso in posizione 0	Double acting, A to T and B closed in 0 position	•	•	•	•
208	Doppio effetto, B in T e A chiuso in posizione 0	Double acting, B to T and A closed in 0 position	•	•	•	•
209	Semplice effetto in A, A in T in posizione 0	Single acting in A, A to T in 0 position	•	•	•	•
210	Semplice effetto in B, B in T in posizione 0	Single acting in B, B to T in 0 position	•	•	•	•
211	Doppio effetto, A e B in T in posizione 0	Double acting, A and B to T in 0 position	•	•	•	•
216*	Doppio effetto con 4ª posizione flottante	Double acting with 4th position floating	•	•	•	•
226*	Doppio effetto con 4ª posizione flottante	Double acting with 4th position floating	•	•	•	•

**201**

Semplice effetto in A  
Single acting in A port

**209**

Semplice effetto in A, A in T in posizione 0  
Single acting in A, A to T in 0 position

**202**

Semplice effetto in B  
Single acting in B port

**210**

Semplice effetto in B, B in T in posizione 0  
Single acting in B, B to T in 0 position

**203**

Doppio effetto  
Double acting

**211**

Doppio effetto, A e B in T in posizione 0  
Double acting, A and B to T in 0 position

**207**

Doppio effetto, A in T e B chiuso in posizione 0  
Double acting, A to T and B closed in 0 position

**216**

Doppio effetto con 4ª posizione flottante  
Double acting with 4th position floating

**208**

Doppio effetto, B in T e A chiuso in posizione 0  
Double acting, B to T and A closed in 0 position

**226**

Doppio effetto con 4ª posizione flottante  
Double acting with 4th position floating

Sezione di lavoro e/o elemento intermedio

Working section and/or intermediate section

Q30	F7S	R250	MSE	E50	R250	2x	103	A1	M1	V30	R250	V01	F3D	12V	2E+1
1	2	3	4	5	6		7	8	9	10	11	12	13	16	17

Cursori sensibilizzati / Sensitized spools

Q30	GSV50	Q80	Q130
-----	-------	-----	------

101.20	Semplice effetto in A	Single acting in A port	•			
102.20	Semplice effetto in B	Single acting in B port	•			
103.05	Doppio effetto, A e B chiusi in posizione 0	Double acting, A and B closed in 0 position	•	•		
103.10	Doppio effetto, A e B chiusi in posizione 0	Double acting, A and B closed in 0 position			•	
103.20	Doppio effetto, A e B chiusi in posizione 0	Double acting, A and B closed in 0 position	•			
103.25	Doppio effetto, A e B chiusi in posizione 0	Double acting, A and B closed in 0 position	•			
103.30	Doppio effetto, A e B chiusi in posizione 0	Double acting, A and B closed in 0 position			•	
103.40	Doppio effetto, A e B chiusi in posizione 0	Double acting, A and B closed in 0 position	•			
103.50	Doppio effetto, A e B chiusi in posizione 0	Double acting, A and B closed in 0 position				•
103.60	Doppio effetto, A e B chiusi in posizione 0	Double acting, A and B closed in 0 position				•
103.80	Doppio effetto, A e B chiusi in posizione 0	Double acting, A and B closed in 0 position				•
107.20	Doppio effetto, A in T e B chiuso in posizione 0	Double acting, A to T and B closed in 0 position	•			
108.20	Doppio effetto, B in T e A chiuso in posizione 0	Double acting, B to T and A closed in 0 position	•			
111.05	Doppio effetto, A e B in T in posizione 0	Double acting, A and B to T in 0 position	•	•		
111.10	Doppio effetto, A e B in T in posizione 0	Double acting, A and B to T in 0 position	•		•	
111.20	Doppio effetto, A e B in T in posizione 0	Double acting, A and B to T in 0 position	•			
111.25	Doppio effetto, A e B in T in posizione 0	Double acting, A and B to T in 0 position	•			
111.30	Doppio effetto, A e B in T in posizione 0	Double acting, A and B to T in 0 position			•	
111.40	Doppio effetto, A e B in T in posizione 0	Double acting, A and B to T in 0 position	•			

101.20

Semplice effetto in A  
Single acting in A port

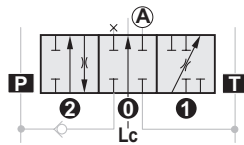

103.20

Doppio effetto, A e B chiusi in posizione 0  
Double acting, A and B closed in 0 position

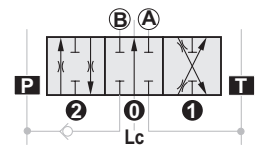

102.20

Semplice effetto in B  
Single acting in B port

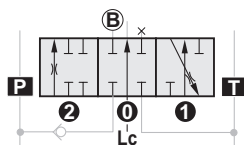

103.25

Doppio effetto, A e B chiusi in posizione 0  
Double acting, A and B closed in 0 position

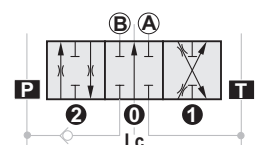

103.05

Doppio effetto, A e B chiusi in posizione 0  
Double acting, A and B closed in 0 position

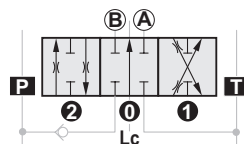

103.30

Doppio effetto, A e B chiusi in posizione 0  
Double acting, A and B closed in 0 position

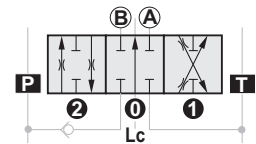

103.10

Doppio effetto, A e B chiusi in posizione 0  
Double acting, A and B closed in 0 position

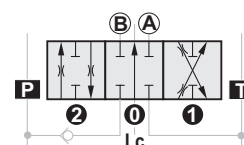

103.40

Doppio effetto, A e B chiusi in posizione 0  
Double acting, A and B closed in 0 position

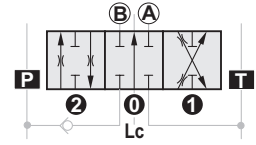

Sezione di lavoro e/o elemento intermedio

Working section and/or intermediate section

Q30	F7S	R250	MSE	E50	R250	2x	103	A1	M1	V30	R250	V01	F3D	12V	2E+1
1	2	3	4	5	6		7	8	9	10	11	12	13	16	17

Cursori sensibilizzati

103.50

Doppio effetto, A e B chiusi in posizione 0  
*Double acting, A and B closed in 0 position*

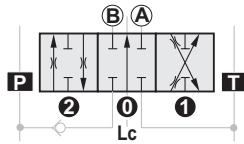

111.10

Doppio effetto, A e B in T in posizione 0  
*Double acting, A and B to T in 0 position*

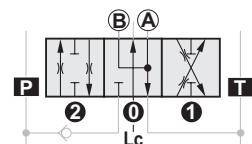

103.60

Doppio effetto, A e B chiusi in posizione 0  
*Double acting, A and B closed in 0 position*

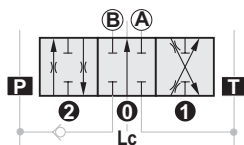

111.20

Doppio effetto, A e B in T in posizione 0  
*Double acting, A and B to T in 0 position*

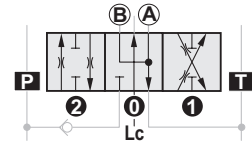

103.80

Doppio effetto, A e B chiusi in posizione 0  
*Double acting, A and B closed in 0 position*

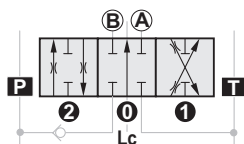

111.25

Doppio effetto, A e B in T in posizione 0  
*Double acting, A and B to T in 0 position*

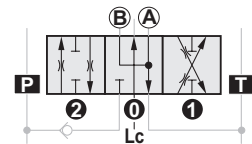

107.20

Doppio effetto, A in T e B chiuso in posizione 0  
*Double acting, A to T and B closed in 0 position*

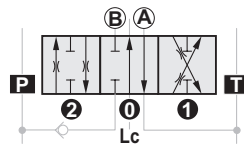

111.30

Doppio effetto, A e B in T in posizione 0  
*Double acting, A and B to T in 0 position*

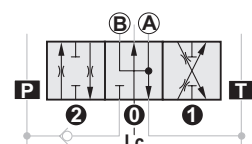

108.20

Doppio effetto, B in T e A chiuso in posizione 0  
*Double acting, B to T and A closed in 0 position*

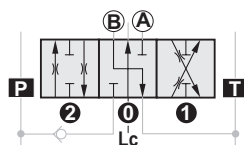

111.40

Doppio effetto, A e B in T in posizione 0  
*Double acting, A and B to T in 0 position*

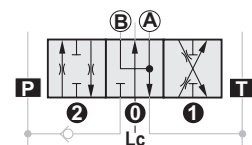

111.05

Doppio effetto, A e B in T in posizione 0  
*Double acting, A and B to T in 0 position*

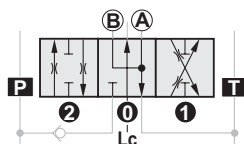

## Sezione di lavoro e/o elemento intermedio

## Working section and/or intermediate section

Q30	F7S	R250	MSE	E50	R250	2x	103	A1	M1	V30	R250	V01	F3D	12V	2E+1
1	2	3	4	5	6		7	8	9	10	11	12	13	16	17

## 8 - Tipo di comando / Control type

			Q30	GSV50	Q80	Q130
<b>A1</b>	Comando manuale con leva standard	Hand control with standard lever	•	•	•	•
<b>A1/Z1*</b>	Versione con kit distanziale per il montaggio del cursore 116	Version with spacer kit for installation of spool 116	•	•	•	•
<b>A1S</b>	Comando manuale con leva di sicurezza	Hand control with safety lever	•	•	•	•
<b>A2</b>	Comando manuale con leva standard ruotata di 180°	Hand control with standard lever mounted rotated 180°	•	•	•	•
<b>A2/Z1*</b>	Versione con kit distanziale per il montaggio del cursore 116	Version with spacer kit for installation of spool 116	•	•	•	•
<b>A2S</b>	Comando manuale con leva di sicurezza ruotata di 180°	Hand control with safety lever rotated 180°	•	•	•	•
<b>A3*</b>	Scatola di protezione in sostituzione del comando manuale con leva	Cap replacing hand control with lever	•	•	•	•
<b>A4</b>	Attacco diretto sul cursore per rinvio a distanza rigido	Direct control connection on spool for stiff remote control	•	•	•	•
<b>A4/Z1*</b>	Versione con kit distanziale per il montaggio del cursore 116	Version with spacer kit for installation of spool 116	•	•	•	•
<b>A5</b>	Attacco diretto sul cursore con terminale sferico (da utilizzare solo con il posizionamento M4 (2-1))	Direct control connection on spool with spherical end (Control to be used for positioning M4 (2-1))	•	•	•	•
<b>A6</b>	Attacco diretto sul cursore con terminale ad occhio fisso	Direct control connection on spool eye end	•	•	•	•
<b>A6/Z1*</b>	Versione con kit distanziale per il montaggio del cursore 116	Version with spacer kit for installation of spool 116	•	•	•	•
<b>A8</b>	Attacco diretto sul cursore per cavo flessibile rinvio a distanza	Direct connection on spool for remote flexible control	•	•	•	•
<b>A8/Z1*</b>	Versione con kit distanziale per il montaggio del cursore 116	Version with spacer kit for installation of spool 116	•	•	•	•
<b>C1*</b>	Cavo flessibile	Flexible cable	•	•	•	•
<b>SL*</b>	Comando a distanza	Remote control	•	•	•	•
<b>SLA15*</b>	Comando a cloche per controllo simultaneo di due cursori a distanza	Remote dual axis control for simultaneous operation of two spools	•	•	•	•

## \* Limitazioni / Limitations

Comando Control	Applicabile con: / Applicable with:	
	Comando / Control	Cursore / Spool
<b>A3</b>	M1-U1 / M2-U1 / M3-U1 / M1-U2 / M2-U2 / M3-U2 / D2 / P1-N / P1-NP / D3	Tutti / All
<b>C1</b>	A8 / M1U2 - M2U2 - M3U2	
<b>SL</b>		
<b>SLA15</b>		

Comando Control	Applicabile con: / Applicable with:	
	Posizionatore / Positioner	Cursore / Spool
<b>A1/Z1</b> <b>A2/Z1</b> <b>A4/Z1</b> <b>A6/Z1</b> <b>A8/Z1</b>	R8	116

Sezione di lavoro e/o elemento intermedio

Working section and/or intermediate section

Q30	F7S	R250	MSE	E50	R250	2x	103	A1	M1	V30	R250	V01	F3D	12V	2E+1
1	2	3	4	5	6		7	8	9	10	11	12	13	16	17

**A1**    **A1/Z1**

A1: Comando manuale con leva standard  
 A1: Hand control with standard lever

A1/Z1: Versione con kit distanziale per il montaggio del cursore 116  
 A1/Z1: Version with spacer kit for installation of spool 116

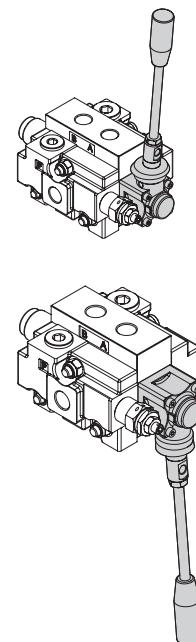
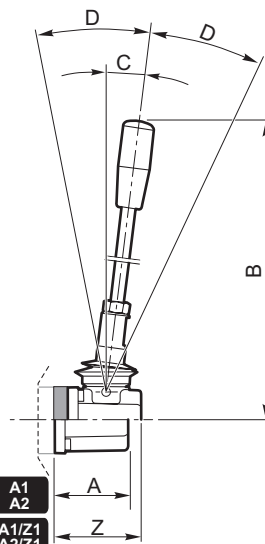
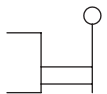

**A2**    **A2/Z1**

A2: Comando manuale con leva standard ruotata di 180°  
 A2: Hand control with standard lever rotated 180°

A2/Z1: Versione con kit distanziale per il montaggio del cursore 116  
 A2/Z1: Version with spacer kit for installation of spool 116

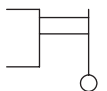

	A	B	C	D	Z
<b>Q30 - GSV50</b>	42 (1.654)	211 (8.307)	5°	13°	50.5 (1.988)
<b>Q80 - Q130</b>	55 (2.165)	260 (10.236)	6°	19°	68.5 (2.697)

A1  
A2  
A1/Z1  
A2/Z1

**A1S**

A1S: Comando manuale con leva di sicurezza  
 A1S: Hand control with safety lever

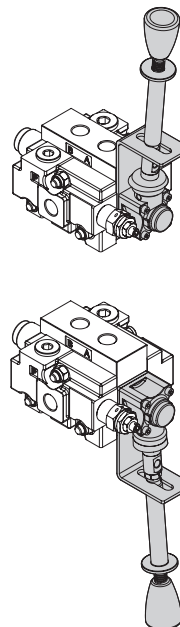
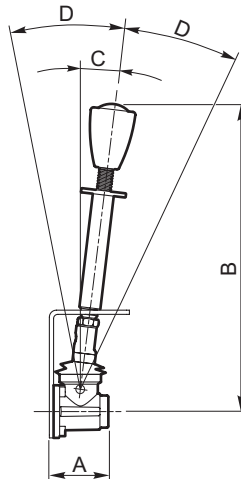
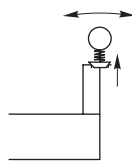

**A2S**

A2S: Comando manuale con leva di sicurezza ruotata di 180°  
 A2S: Hand control with safety lever rotated 180°

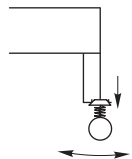

	A	B	C	D
<b>Q30 - GSV50</b>	42 (1.654)	225 (8.858)	5°	13°
<b>Q80 - Q130</b>	55 (2.165)	256 (10.079)	6°	19°

**A3**

Scatola di protezione in sostituzione del comando manuale con leva  
 Cap replacing hand control with lever

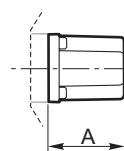
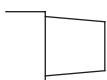

	A
<b>Q30 - GSV50</b>	42 (1.654)
<b>Q80 - Q130</b>	55 (2.165)

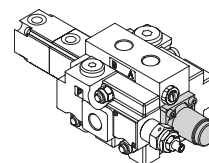

## Sezione di lavoro e/o elemento intermedio

## Working section and/or intermediate section

Q30	F7S	R250	MSE	E50	R250	2x	103	A1	M1	V30	R250	V01	F3D	12V	2E+1
1	2	3	4	5	6		7	8	9	10	11	12	13	16	17

## A4

## A4/Z1

A4: Attacco diretto sul cursore per rinvio a distanza rigido  
 A4: Direct control connection on spool for stiff remote control

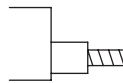

A4/Z1: Versione con kit distanziale per il montaggio del cursore 116  
 A4/Z1: Version with spacer kit for installation of spool 116

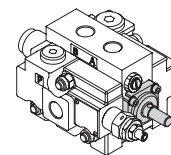
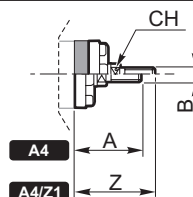

	A	B	CH	Corsa Stroke	Z
Q30 - GSV50	39 (1.535)	M8	9 (0.354)	±5 (0.197)	47.5 (1.870)
Q80 - Q130	53 (2.087)	M10	14 (0.551)	±7 (0.276)	66.5 (2.618)

## A5

A5: Attacco diretto sul cursore con terminale sferico (da utilizzare solo con il posizionamento M4 (2-1))  
 A5: Direct control connection on spool with spherical end (Control to be used for positioning M4 (2-1))

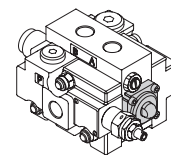
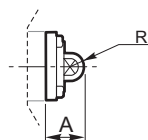
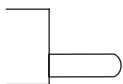

	A	R	Corsa Stroke
Q30 - GSV50	22 (0.866)	6.85 (0.270)	±5 (0.197)
Q80 - Q130	33 (1.299)	8.75 (0.344)	±7 (0.276)

## A6

## A6/Z1

A6: Attacco diretto sul cursore con terminale ad occhio fisso  
 A6: Direct control connection on spool eye end

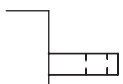

A6/Z1: Versione con kit distanziale per il montaggio del cursore 116  
 A6/Z1: Version with spacer kit for installation of spool 116

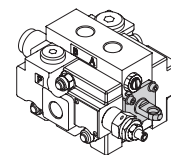
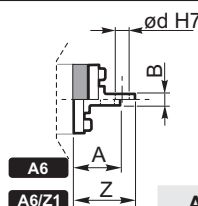

	A	B	d	Corsa Stroke	Z
Q30 - GSV50	20 (0.787)	6 (0.236)	9 (0.354)	±5 (0.197)	28.5 (1.122)
Q80 - Q130	27 (1.063)	7 (0.276)	11 (0.433)	±7 (0.276)	40.5 (1.594)

## A8

## A8/Z1

A8: Attacco diretto sul cursore per cavo flessibile rinvio a distanza  
 A8: Direct connection on spool for remote flexible control

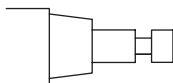

A8/Z1: Versione con kit distanziale per il montaggio del cursore 116  
 A8/Z1: Version with spacer kit for installation of spool 116

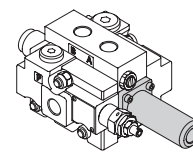
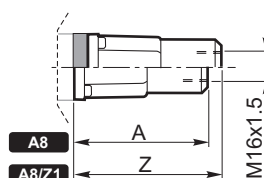

	A	Z
Q30 - GSV50	73 (2.874)	81.5 (3.209)
Q80 - Q130	77 (3.031)	90.5 (3.563)

Sezione di lavoro e/o elemento intermedio

Working section and/or intermediate section

Q30	F7S	R250	MSE	E50	R250	2x	103	A1	M1	V30	R250	V01	F3D	12V	2E+1
1	2	3	4	5	6		7	8	9	10	11	12	13	16	17

C1

Cavo flessibile  
Flexible cable

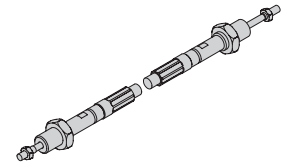
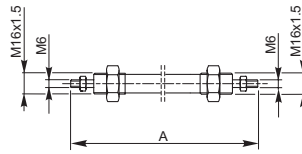
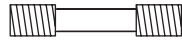

A

Q30 - GSV50  
Q80 - Q130

Massima lunghezza cavo consigliata 4000 mm  
Raggio min. di curvatura 200mm  
Max. recommended length 4000 mm  
Minimum radius curve 200 mm

Dove è utilizzato il cavo flessibile C1, è necessario indicare la lunghezza del cavo espressa in mm.  
Esempio per un cavo lungo 1000 mm: **A8-C1x1000-SL**

Indicate the cable length in mm when flexible cable C1 is used.  
E.g.: for a cable 1000 mm in length: **A8-C1x1000-SL**

SL

Comando a distanza  
Remote control

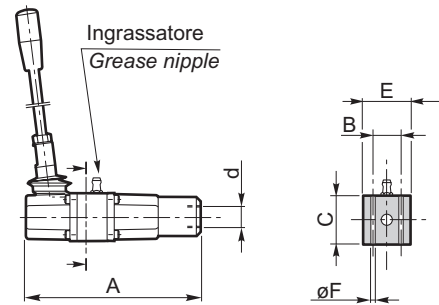
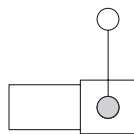
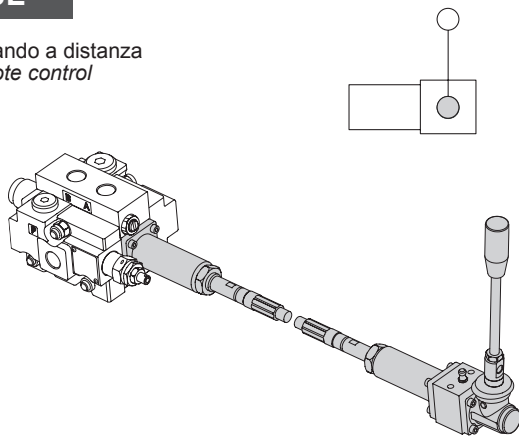

	A	B	C	d	E	F
Q30 - GSV50	135 (5.315)	26 (1.024)	40 (1.575)	M16x1.5	38 (1.496)	5.5 (0.217)
Q80 - Q130	172 (6.772)	33.5 (1.319)	45 (1.772)		45 (1.772)	6.5 (0.256)

SLA15

Comando a cloche per controllo simultaneo di due cursori a distanza  
Remote dual axis control for simultaneous operation of two spools

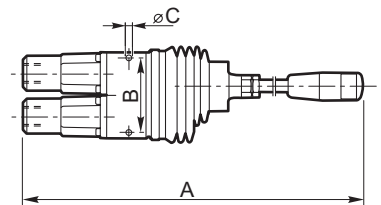
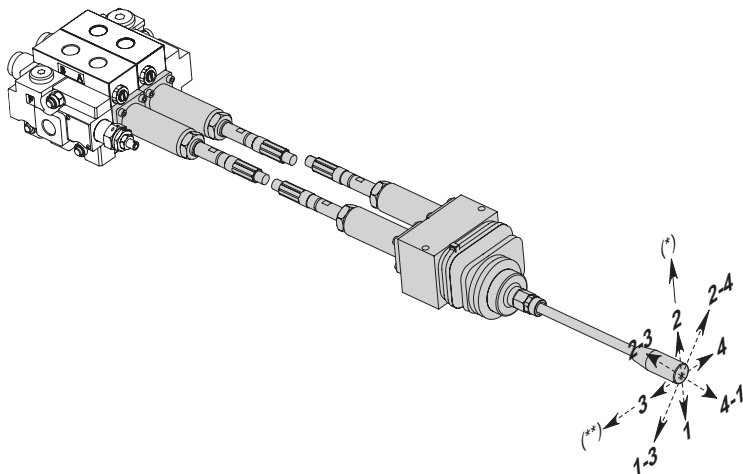
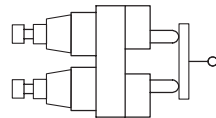

	A	B	Ø d
Q30 - GSV50	358 (14.094)	77 (3.031)	6.5 (0.256)
Q80 - Q130			

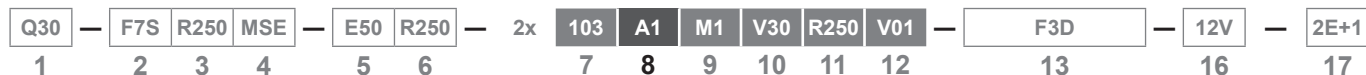

8 - Tipo di comando / Control type

		Q30	GSV50	Q80	Q130
	Leva a cloche per il comando singolo o simultaneo di due cursori: <i>Dual axis for single or simultaneous control of two spools:</i>				
<b>A35</b>	- movimento inclinato a X <i>- tilted movement to X</i>	•	•	•	•
<b>A16</b>	- movimento dritto a + <i>- Straight movement to +</i>	•			
	Comando manuale con attivazione del contatto elettrico del microswitch centralizzato: <i>Hand control with ON-OFF centralized microswitch operation</i>				
<b>N1-A1</b>	- per doppio effetto <i>- double acting</i>	•	•	•	•
<b>N1A-A1</b>	- per semplice effetto in posizione 1 <i>- single acting in 1 position</i>	•	•	•	•
<b>N1B-A1</b>	- per semplice effetto in posizione 2 <i>- single acting in 2 position</i>	•	•	•	•
	Comando manuale, ruotato di 180°, con attivazione del contatto elettrico del microswitch centralizzato: <i>180° Rotated hand control with ON-OFF centralized microswitch operation</i>				
<b>N1-A2</b>	- per doppio effetto <i>- double acting</i>	•	•	•	•
<b>N1A-A2</b>	- per semplice effetto in posizione 1 <i>- single acting in 1 position</i>	•	•	•	•
<b>N1B-A2</b>	- per semplice effetto in posizione 2 <i>- single acting in 2 position</i>	•	•	•	•
	Comando microswitch centralizzato: <i>Centralized microswitch control:</i>				
<b>N1-A3</b>	- per doppio effetto <i>- double acting</i>	•	•	•	•
<b>N1A-A3</b>	- per semplice effetto in posizione 1 <i>- single acting in 1 position</i>	•	•	•	•
<b>N1B-A3</b>	- per semplice effetto in posizione 2 <i>- single acting in 2 position</i>	•	•	•	•

**A35**

Leva a cloche per il comando singolo o simultaneo di due cursori, come schema a lato  
*Dual axis for simultaneous or single control of two spools, as from the scheme on the side*

	A
<b>Q30 - GSV50</b>	280 (11.024)
<b>Q80 - Q130</b>	300 (11.811)

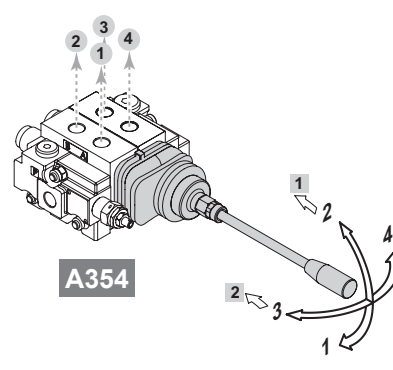
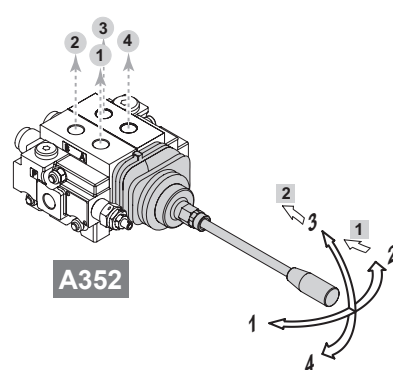
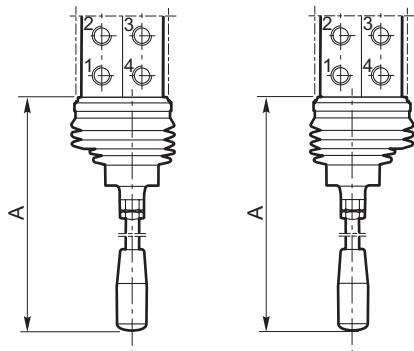
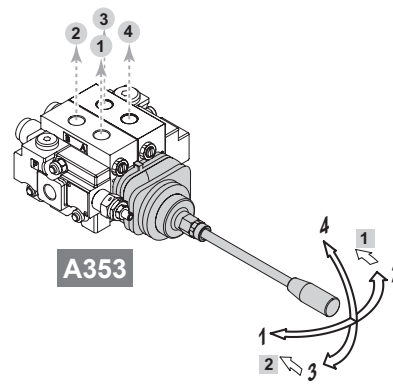
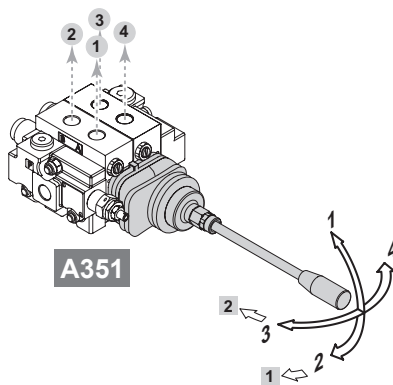
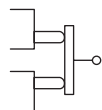

N.B. Nelle configurazioni A352 e A354, non è possibile montare le valvole antiurto.  
 Note: A352 - A354 configurations not permitted to mount cartridge valves.

Eventuale cassetto con 4<sup>a</sup> pos. (solo cod.126)  
 Optional spool with 4th position (only code 126)  
 1 su 1<sup>a</sup> sezione / on 1<sup>st</sup> section  
 2 su 2<sup>a</sup> sezione / on 2<sup>nd</sup> section



## Sezione di lavoro e/o elemento intermedio

## Working section and/or intermediate section

Q30	F7S	R250	MSE	E50	R250	2x	103	A1	M1	V30	R250	V01	F3D	12V	2E+1
1	2	3	4	5	6		7	8	9	10	11	12	13	16	17

## A16

Leva a cloche per il controllo singolo o simultaneo di due cursori come a schema sottoindicato  
*Dual axis for single or simultaneous control of two spools as from the scheme here below*

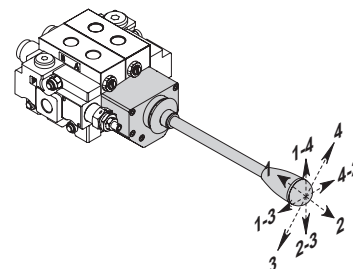
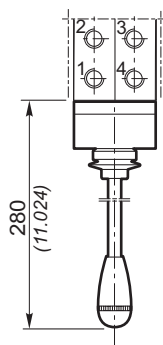
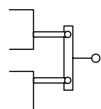

I comandi **A15**, **A16** o **SLA15** sono dei joystick che comandano due sezioni di lavoro; essendo un comando unico viene inserito come codice solo nella prima sezione di lavoro e viene omesso nella seconda.

## Esempio

Q30 – F7SR250 – 103/**A15**/M1 – 103/M1 – F3D

Nella seconda sezione di lavoro è indicato solo il cursore e il posizionario.

Quando è richiesto anche il cavo C1, è necessario specificarne la lunghezza in entrambe le sezioni.

## Esempio

Q30 – F7SR250 – 103/**A8-C1x1000**-SLA15/M1 – 103/**A8-C1x1000**/M1 – F3D

*Controls **A15**, **A16** or **SLA15** are joysticks that control two working sections. Since it is a single control, it is only entered as a code in the first work section and is omitted from the second.*

## Example

*Q30 – F7SR250 – 103/**A15**/M1 – 103/M1 – F3D*

*Only the spool and positioner are indicated in the second working section.*

*When cable C1 is also required, its length must be specified in both sections.*

## Example

*Q30 – F7SR250 – 103/**A8-C1x1000**-SLA15/M1 – 103/**A8-C1x1000**/M1 – F3D*

Sezione di lavoro e/o elemento intermedio

Working section and/or intermediate section

Q30	F7S	R250	MSE	E50	R250	2x	103	A1	M1	V30	R250	V01	F3D	12V	2E+1
1	2	3	4	5	6		7	8	9	10	11	12	13	16	17

**N1-A1**  
**N1A-A1**  
**N1B-A1**

Comando manuale con attivazione del contatto elettrico del microswitch centralizzato.

- N1-A1: Per doppio effetto
- N1A-A1: Per semplice effetto in pos. 1
- N1B-A1: Per semplice effetto in pos. 2
- Hand control with ON-OFF centralized microswitch operation.
- N1 -A1: Double acting
- N1A-A1: Single acting in 1 position
- N1B-A1: Single acting in 2 position

Con le valvole a cartuccia occorre montare il comando ruotato di 180° oppure inserire il distanziale cod. Z1  
With cartridge valves it is necessary to mount the 180° rotated control or to insert a spacer code Z1

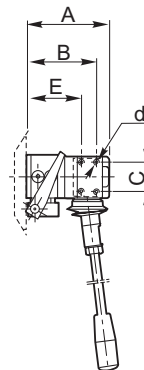
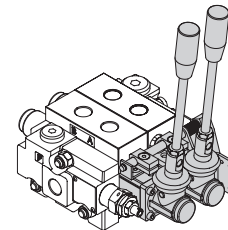
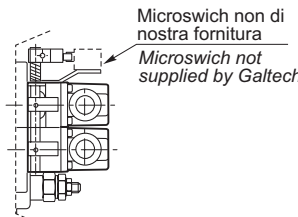
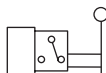

	A	B	C	E	d
Q30 - GSV50	70 (2.756)	59	25	49	M4
Q80 - Q130	84 (3.307)	(2.323)	(0.984)	(1.929)	

**N1-A2**  
**N1A-A2**  
**N1B-A2**

Comando manuale ruotato di 180° con attivazione del contatto elettrico del microswitch centralizzato.

- N1-A2: Per doppio effetto
- N1A-A2: Per semplice effetto in pos. 1
- N1B-A2: Per semplice effetto in pos. 2
- 180° rotated hand control with ON-OFF centralized microswitch operation.
- N1-A2: Double acting
- N1A-A2: Single acting in 1 position
- N1B-A2: Single acting in 2 position

Con le valvole a cartuccia occorre montare il comando ruotato di 180° oppure inserire il distanziale cod. Z1  
With cartridge valves it is necessary to mount the 180° rotated control or to insert a spacer code Z1

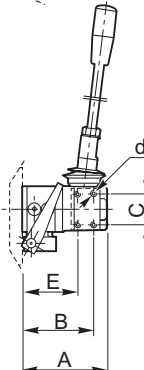
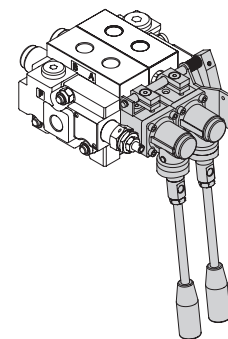
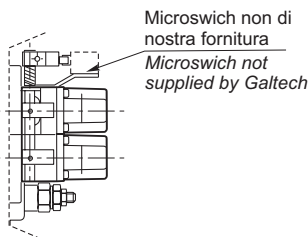
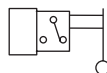

	A	B	C	E	d
Q30 - GSV50	70 (2.756)	59	25	49	M4
Q80 - Q130	84 (3.307)	(2.323)	(0.984)	(1.929)	

**N1-A3**  
**N1A-A3**  
**N1B-A3**

Comando microswitch centralizzato.

- N1-A3: Per doppio effetto
- N1A-A3: Per semplice effetto in pos. 1
- N1B-A3: Per semplice effetto in pos. 2
- Centralized microswitch control.
- N1-A3: Double acting
- N1A-A3: Single acting in 1 position
- N1B-A3: Single acting in 2 position

Con le valvole a cartuccia occorre montare il comando ruotato di 180° oppure inserire il distanziale cod. Z1  
With cartridge valves it is necessary to mount the 180° rotated control or to insert a spacer code Z1

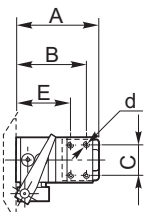
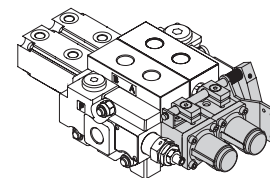
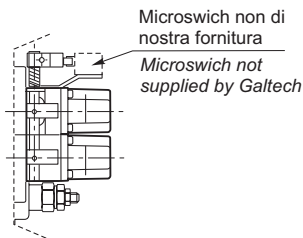
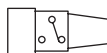

## Sezione di lavoro e/o elemento intermedio

## Working section and/or intermediate section

Q30	F7S	R250	MSE	E50	R250	2x	103	A1	M1	V30	R250	V01	F3D	12V	2E+1
1	2	3	4	5	6		7	8	9	10	11	12	13	16	17

## 9 - Tipo posizionario

\* La posizione dei campi 8 e 9 si riferisce al comando collocato sul lato effetto A e al posizionario lato effetto B; se le posizioni sono opposte, invertire i due campi 5 e 6 come da esempio seguente:

A1	M1
8 - 9	

Comando lato effetto A  
Posizionario lato effetto B  
Port A side control  
Port B side positioner

## 6 - Positioner type

\* The position of fields 8 and 9 refers to the control located on the A port side and to the positioner on the B port side. If the positions are opposite, invert the two fields 5 and 6 as shown in the example below:

M1	A1
9 - 8	

Comando lato effetto B  
Posizionario lato effetto A  
Port B side control  
Port A side positioner

## Posizionatori

		Q30	GSV50	Q80	Q130
M1	Tre posizioni ritorno a molla in pos.0	•	•	•	•
M2	Due posizioni 0-1 ritorno a molla in pos.0	•	•	•	•
M3	Due posizioni 0-2 ritorno a molla in pos.0	•	•	•	•
M4(1-2)	Due posizioni estreme ritorno a molla in pos.1	•	•	•	•
M4(2-1)	Due posizioni estreme ritorno a molla in pos.2	•	•	•	•
R0	Posizionamento frizionato	•	•	•	•
R1	Tre posizioni ritorno a molla in pos.0, detent in pos.1	•	•	•	•
R2	Tre posizioni ritorno a molla in pos.0, detent in pos.2	•	•	•	•
R3	Tre posizioni in detent	•	•	•	•
R4	Due posizioni in detent 0-1	•	•	•	•
R5	Due posizioni in detent 0-2	•	•	•	•
R6	Due posizioni in detent 1-2	•	•	•	•
R8*	Due posizioni (1 e 2) con ritorno a molla in pos. 0; (3) 4ª posizione flottante con detent. (Da montare con Z1 lato comando e cursore 116)	•	•	•	•
R10/Z1	Due posizioni (1 e 2) con ritorno a molla in pos. 0, (3) 4ª posizione flottante con detent (da montare con cursore 126)	•	•	•	•
R1K*	Comando a 3 posizioni, detent in pos. 1 con sgancio automatico registrabile. Disponibile solo con cursore cod. 103 e 111	•	•	•	•
R2K*	Comando a 3 posizioni, detent in pos. 2 con sgancio automatico registrabile. Disponibile solo con cursore cod. 103 e 111	•	•	•	•
R3K*	Comando a 3 posizioni, detent in pos. 1 e 2 con sgancio automatico registrabile. Disponibile solo con cursore cod. 103 e 111	•	•	•	•
M1-B1	Tre posizioni ritorno a molla in pos.0 con comando microswitch posteriore	•	•	•	•
M2-B1	Due posizioni, 0-1, ritorno a molla in pos.0 con comando microswitch posteriore	•	•	•	•
M3-B1	Due posizioni, 0-2, ritorno a molla in pos. 0 con comando microswitch posteriore	•	•	•	•
M1-N1	Tre posizioni ritorno a molla in pos. 0, con attivazione del contatto elettrico del microswitch centralizzato	•	•	•	•
M1-N1A	M1-N1: Per doppio effetto	•	•	•	•
M1-N1B	M1-N1A: Per semplice effetto in pos 1 M1-N1B: Per semplice effetto in pos 2	•	•	•	•
M2-N1	Due posizioni, 0-1, con ritorno a molla in pos.0, con attivazione del contatto elettrico del microswitch centralizzato	•	•	•	•
M3-N1	Due posizioni, 0-2, con ritorno a molla in pos.0, con attivazione del contatto elettrico del microswitch centralizzato	•	•	•	•
M1-B4	Posizionamento con micro a tenuta stagna	•	•	•	•

## \* Limitazioni / Limitations

Posizionario Positioner	Applicabile con: / Applicable with:		
	Comando / Control	Cursore / Spool	Valvole / Valves
R8	A1/Z1 - A2/Z1 - A4/Z1 - A6/Z1 - A8/Z1	116	Tutte le valvole a cartuccia e tutte le valvole a pannello All cartridge and panel valves
R10/Z1	Tutti / All	126	
R1K R2K R3K	A1 / A2 / A4 / A5 / A6 / A8 / SL / SLA15 / A15 / A16 / N1-A1 / N1-A2 / N1-A3	103 / 111	

Sezione di lavoro e/o elemento intermedio

Working section and/or intermediate section

Q30	F7S	R250	MSE	E50	R250	2x	103	A1	M1	V30	R250	V01	F3D	12V	2E+1
1	2	3	4	5	6		7	8	9	10	11	12	13	16	17

**M1**

Tre posizioni ritorno a molla in pos.0  
*Three positions spring centred in 0*



**M2**

Due posizioni 0-1 ritorno a molla in pos.0  
*Two positions spring 0-1 centred in 0*

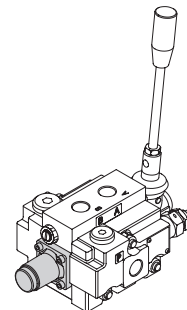
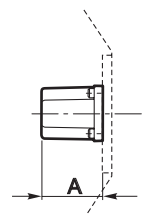

**M3**

Due posizioni 0-2 ritorno a molla in pos.0  
*Two positions spring 0-2 centred in 0*



**M4 (1-2)**

Due posizioni estreme ritorno a molla in pos.1  
*Two end positions spring back in 1*



**M4 (2-1)**

Due posizioni estreme ritorno a molla in pos.2  
*Two end positions spring back in 2*



	A			
	M1	M2	M3	M4 2-1
Q30 - GSV50	42 (1.654)	42 (1.654)	42 (1.654)	42 (1.654)
Q80 - Q130	55 (2.165)	55 (2.165)	55 (2.165)	55 (2.165)

Sezione di lavoro e/o elemento intermedio

Working section and/or intermediate section

Q30	F7S	R250	MSE	E50	R250	2x	103	A1	M1	V30	R250	V01	F3D	12V	2E+1
1	2	3	4	5	6		7	8	9	10	11	12	13	16	17

R0

Posizionamento frizionato  
Friction positioner

Q30 - GSV50

Frizione non registrabile  
Not adjustable friction

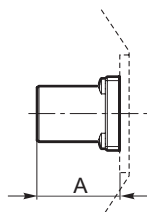
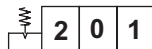

A

Q30 - GSV50	42 (1.653)
-------------	---------------

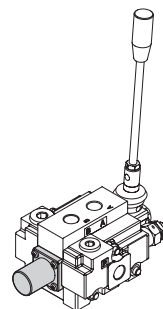

Q80 - Q130

Frizione registrabile  
Adjustable friction

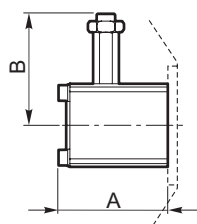
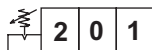

A B

Q80 - Q130	59 (2.323)	60 (2.362)
------------	---------------	---------------

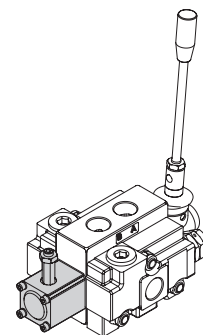

R1

Tre posizioni ritorno a molla in pos.0,  
detent in pos.1  
Three positions spring centred in 0,  
detent in 1

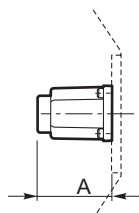

A

	R1	R2
Q30 - GSV50	52 (2.047)	54 (2.126)
Q80 - Q130	70 (2.756)	68.5 (2.697)

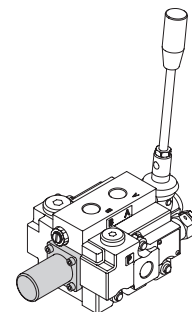

R2

Tre posizioni ritorno a molla in pos.0,  
detent in pos.2  
Three positions spring centred in 0,  
detent in 2



R3

Tre posizioni in detent  
Three positions detent

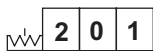

R4

Due posizioni in detent 0-1  
Two positions detent 0-1



R5

Due posizioni in detent 0-2  
Two positions detent 0-2



R6

Due posizioni in detent 1-2  
Two positions detent 1-2

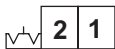

	A			
	R3	R4	R5	R6
Q30 - GSV50	42 (1.654)	42 (1.654)	42 (1.654)	42 (1.654)
Q80 - Q130	55 (2.165)	55 (2.165)	55 (2.165)	55 (2.165)

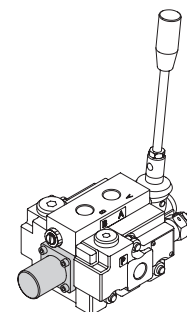

Sezione di lavoro e/o elemento intermedio

Working section and/or intermediate section

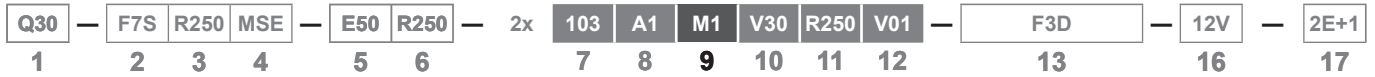

R8

Due posizioni (1 e 2) con ritorno a molla in pos. 0; (3) 4ª posizione flottante con detent.  
 (Da montare con Z1 lato comando e cursore 116)  
 Two positions (1 and 2) with spring return centred in 0 position.  
 (3) 4th position floating with detent.  
 (Mounting with Z1 side control and spool 116)

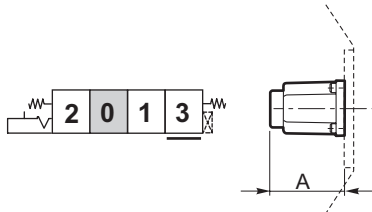

	A
Q30 - GSV50	56.5 (2.224)
Q80	75 (2.953)
Q130	80 (3.150)

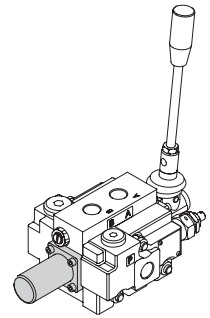

R10/Z1

Due posizioni (1 e 2) con ritorno a molla in pos. 0; (3) 4ª posizione flottante con detent  
 (Da montare cursore 126)  
 Two positions (1 and 2) with spring return centred in 0 position  
 (3) 4th position floating with detent.  
 (Mounting with spool 126)

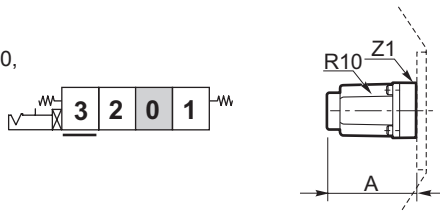

	A
Q30 - GSV50	70 (2.756)
Q80	92 (3.622)

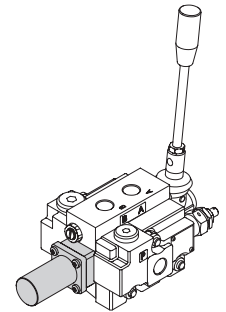

R1K

Comando a 3 posizioni, detent in pos. 1 con sgancio automatico registrabile.  
 Disponibile solo con cursore cod. 103 e 111  
 3 Position control, detent in 1 pos. with automatic adjustable release.  
 Available with spool code 103 and 111 only

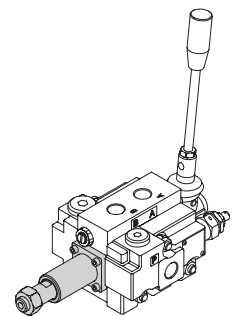
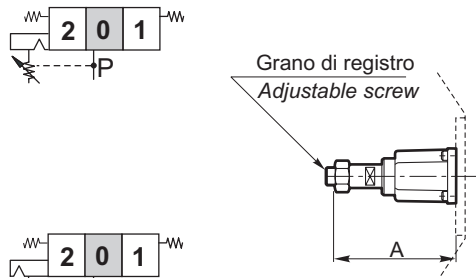

R2K

Comando a 3 posizioni, detent in pos. 2 con sgancio automatico registrabile.  
 Disponibile solo con cursore cod. 103 e 111  
 3 Position control, detent in 2 pos. with automatic adjustable release.  
 Available with spool code 103 and 111 only

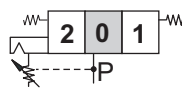

R3K

Comando a 3 posizioni, detent in pos. 1 e 2 con sgancio automatico registrabile.  
 Disponibile solo con cursore cod. 103 e 111  
 3 Position control, detent in 1 and 2 pos. with automatic adjustable release.  
 Available with spool code 103 and 111 only

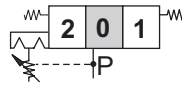

	A		
	R1K	R2K	R3K
Q30 - GSV50	91.5 (3.602)	91.5 (3.602)	91.5 (3.602)
Q80 - Q130	106 (4.173)	106 (4.173)	106 (4.173)

Campo di taratura della pressione per lo sgancio automatico 45 - 350 bar (653 - 5075 PSI)  
 Pressure calibration field for automatic release 45 - 350 bar (653 - 5075 PSI)

Sezione di lavoro e/o elemento intermedio

Working section and/or intermediate section

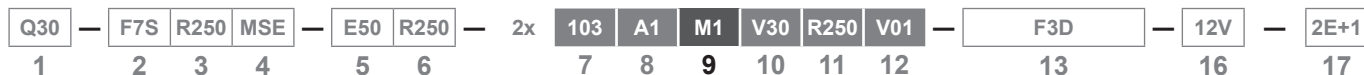

**M1-B1**

Tre posizioni ritorno a molla in pos.0 con comando microswitch posteriore  
 Three positions spring centred in 0 with back microswitch control

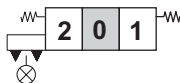

Microswitch non di nostra fornitura

Microswitch not supplied by Galtech

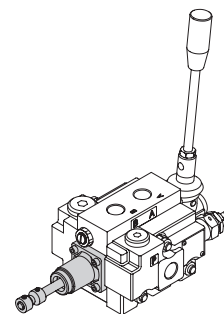
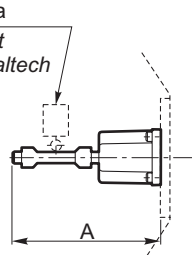

**M2-B1**

Due posizioni, 0-1, ritorno a molla in pos.0 con comando microswitch posteriore  
 Two positions, 0-1, spring centred in 0 with back microswitch control

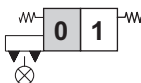

	A		
	M1-B1	M2-B1	M3-B1
Q30 - GSV50	82 (3.228)	82 (3.228)	82 (3.228)
Q80 - Q130	102 (4.016)	102 (4.016)	102 (4.016)

**M3-B1**

Due posizioni, 0-2, ritorno a molla in pos. 0 con comando microswitch posteriore  
 Two positions, 0-2, spring centred in 0 with back microswitch control

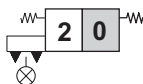

**M1-N1  
M1-N1A  
M1-N1B**

Tre posizioni ritorno a molla in pos. 0, con attivazione del contatto elettrico del microswitch centralizzato  
 M1-N1: Per doppio effetto  
 M1-N1A: Per semplice effetto in pos 1  
 M1-N1B: Per semplice effetto in pos 2  
 Three positions spring centred in 0, with ON-OFF centralized microswitch operation.  
 N1-A1: Double acting  
 N1A-A1: Single acting in 1 position  
 N1B-A1: Single acting in 2 position

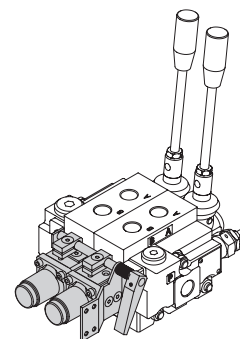
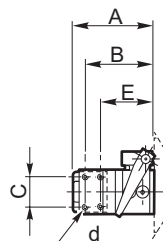
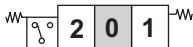

**M2-N1**

Due posizioni, 0-1, con ritorno a molla in pos.0, con attivazione del contatto elettrico del microswitch centralizzato  
 Two positions, 0-1, with spring centred in 0, with ON-OFF centralized microswitch operation

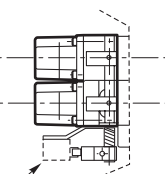

Microswitch non di nostra fornitura  
 Microswitch not supplied by Galtech

**M3-N1**

Due posizioni, 0-2, con ritorno a molla in pos.0, con attivazione del contatto elettrico del microswitch centralizzato  
 Two positions, 0-2, with spring centred in 0, with ON-OFF centralized microswitch operation



	A	B	C	E	d
Q30 - GSV50	70 (2.756)	59	25 (0.984)	49 (1.929)	M4
Q80 - Q130	84 (3.307)				

## Sezione di lavoro e/o elemento intermedio

## Working section and/or intermediate section

Q30	F7S	R250	MSE	E50	R250	2x	103	A1	M1	V30	R250	V01	F3D	12V	2E+1
1	2	3	4	5	6		7	8	9	10	11	12	13	16	17

## M1-B4

Posizionatore con micro a tenuta stagna.  
Positioning with watertight microswitch.

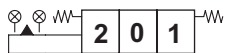

Caratteristiche elettriche / Electrical Characteristic		
Corrente / Current	0.01 ÷ 5.0	Amp
Tensione / Voltage	5 ÷ 24	VDC
Connettore / Connector	Packard weather pack	
Temperatura / Temperature	-40 ÷ 120	°C
Tipo / Type	Normalmente aperto <i>Normally open</i>	

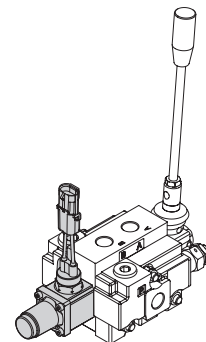
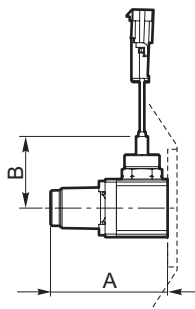

	A	B
Q30 - GSV50	75.5 (2.972)	50 (1.969)



## Sezione di lavoro e/o elemento intermedio

## Working section and/or intermediate section

Q30	F7S	R250	MSE	E50	R250	2x	103	A1	M1	V30	R250	V01	F3D	12V	2E+1
1	2	3	4	5	6		7	8	9	10	11	12	13	16	17

## Comandi con posizionamento / Controls with positioning (pag. XXX)

		Q30	GSV50	Q80	Q130
<b>M1-U1*</b>	Tre posizioni con ritorno a molla in pos.0, attacco diretto sul cursore per rinvio a distanza rigido	•	•	•	•
<b>M2-U1*</b>	Due posizioni, 0-1, con ritorno a molla in pos.0, attacco diretto sul cursore per rinvio a distanza rigido	•	•	•	•
<b>M3-U1*</b>	Due posizioni, 0-2, con ritorno a molla in pos. 0, attacco diretto sul cursore per rinvio a distanza rigido	•	•	•	•
<b>M1-U2*</b>	Tre posizioni con ritorno a molla in pos. 0, attacco diretto sul cursore per rinvio a distanza con cavo flessibile	•	•	•	•
<b>M2-U2*</b>	Due posizioni, 0-1, ritorno a molla in pos. 0, attacco diretto sul cursore per rinvio a distanza con cavo flessibile	•	•	•	•
<b>M3-U2*</b>	Due posizioni, 0-2, ritorno a molla in pos. 0, attacco diretto sul cursore per rinvio a distanza con cavo flessibile	•	•	•	•
<b>D2*</b>	Comando elettroidraulico doppio con ritorno in pos. 0			•	•
<b>P1-N*</b>	Comando pneumatico	•	•	•	•
<b>P1-NP*</b>	Comando pneumatico progressivo	•	•	•	•
<b>D3*</b>	Comando elettropneumatico	•	•	•	•

## \* Limitazioni / Limitations

Posizionatore Positioner	Applicabile con: / Applicable with:	
	Comando / Control	Cursore / Spool
M1-U1 M2-U1 M3-U1 M1-U2 M2-U2 M3-U2 D2 P1-N P1-NP D3	A1 / A2 / A3 / A4 / A6 / A8	Tutti tranne 116 e 126 All except 116 and 126

Sezione di lavoro e/o elemento intermedio

Working section and/or intermediate section

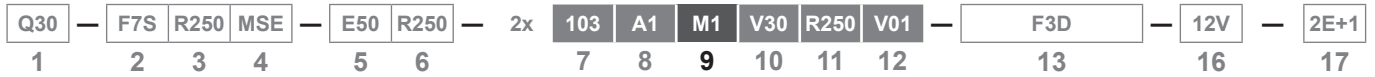

**M1-U1**

Tre posizioni con ritorno a molla in pos.0, attacco diretto sul cursore per rinvio a distanza rigido  
*Three positions spring centred in 0, with direct control connection on spool, cap side, for stiff remote control*



**M2-U1**

Due posizioni, 0-1, con ritorno a molla in pos.0, attacco diretto sul cursore per rinvio a distanza rigido  
*Two positions, 0-1, spring centred in 0, with direct control connection on spool, cap side, for stiff remote control*

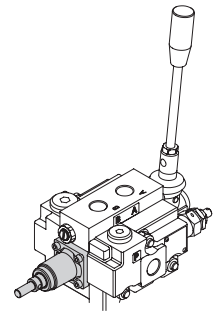
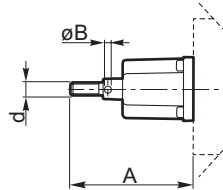

**M3-U1**

Due posizioni, 0-2, con ritorno a molla in pos. 0, attacco diretto sul cursore per rinvio a distanza rigido  
*Two positions, 0-2, spring centred in 0, with direct control connection on spool, cap side, for stiff remote control*



	A	B	d
<b>Q30 - GSV50</b>	73 (2.874)	4 (0.157)	M8
<b>Q80 - Q130</b>	96 (3.780)	5 (0.197)	M10

**M1-U2**

Tre posizioni con ritorno a molla in pos. 0, attacco diretto sul cursore per rinvio a distanza con cavo flessibile  
*Three positions spring centred in 0, direct control connection on spool, cap side, for flexible remote control*



**M2-U2**

Due posizioni, 0-1, ritorno a molla in pos. 0, attacco diretto sul cursore per rinvio a distanza con cavo flessibile  
*Two positions, 0-1, spring centred in 0, direct control connection on spool, cap side, for flexible remote control*

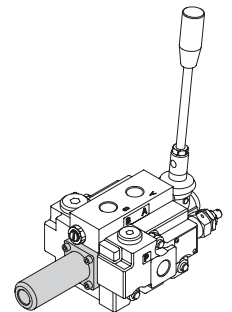
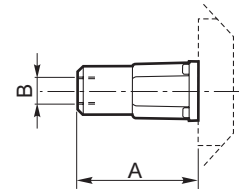

**M3-U2**

Due posizioni, 0-2, ritorno a molla in pos. 0, attacco diretto sul cursore per rinvio a distanza con cavo flessibile  
*Two positions, 0-2, spring centred in 0, direct control connection on spool, cap side, for flexible remote control*



	A	B
<b>Q30 - GSV50</b>	73 (2.874)	M16X1.5
<b>Q80 - Q130</b>	77 (3.031)	

Sezione di lavoro e/o elemento intermedio

Working section and/or intermediate section

Q30	F7S	R250	MSE	E50	R250	2x	103	A1	M1	V30	R250	V01	F3D	12V	2E+1
1	2	3	4	5	6		7	8	9	10	11	12	13	16	17

**D2**

Solo per Q80 e Q130  
Only for Q80 and Q130

Comando elettroidraulico doppio  
con ritorno in pos. 0  
Double electro-hydraulic  
control spring centred in 0

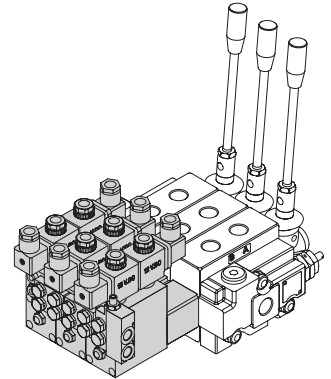
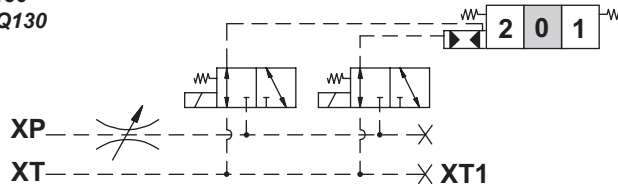

Vite di regolazione  
velocità di commutazione  
Commutation speed  
adjusting screw

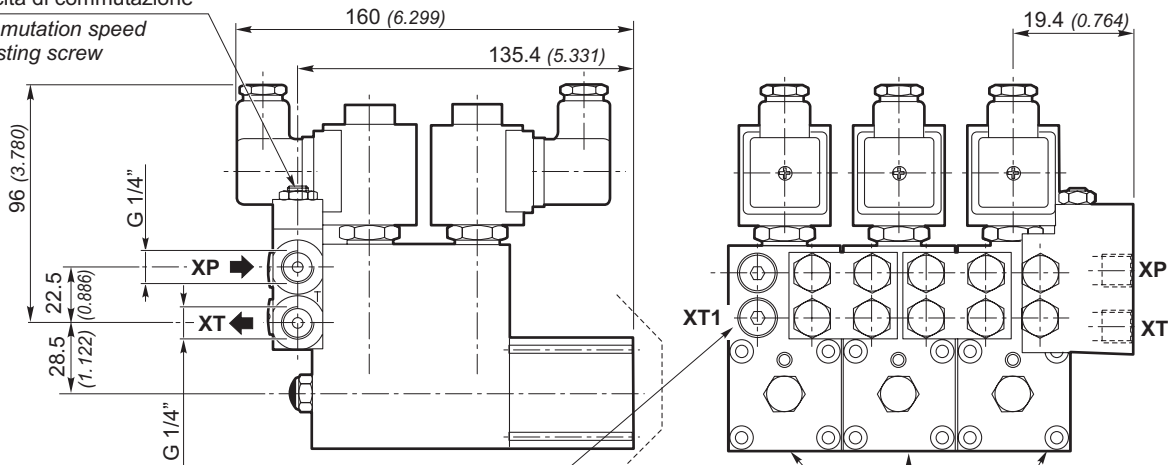

Porta G1/8" da collegare a serbatoio in caso di utilizzo di elemento intermedio cod. E62  
If use the intermediate element E62, connect the port G1/8" to the tank

Codice: D2-2R per elementi successivi  
Code: D2-2R for the following elements

Codice: D2-1R per il 1° elemento  
Code: D2-1R for the 1° elements

Pressione di pilotaggio in XP Pilot pressure in XP		Contropressione max. su XT Maximum back pressure on XT	Portata minima per ogni elemento Minimum flow for each section	Volume di pilotaggio per elemento Piloting volume for each section
Max.	Min.	4 bar (56 PSI)	0.5 lt/min (0.132 GPM)	5.5 cm <sup>3</sup> (0.336 in <sup>3</sup> )
35 bar (490 PSI)	20 bar (280 PSI)			

Caratteristiche tecniche elettromagnete tipo "H" / Electromagnet characteristics type "H"

Attacco magnete / Magnet connection	Tipo DIN 43650 (versione A) / Type DIN 43650 (A version)
Tipo di protezione / Protection type	IP 65
Classe d'isolamento / Coil insulation class	H 180 VDE 0580
Tensione di alimentazione / Supply voltage	D.C.: 12, 24V A.C. - 50 Hz: 110, 220 V
Variazione di tensione max. / Maximum voltage tolerance	± 10%
Potenza assorbita / Absorbed power supply	18 W
Rapporto di max. utilizzo / Maximum utilization ratio	100%
Temperatura max. / Max. temperature	100° C

Sezione di lavoro e/o elemento intermedio

Working section and/or intermediate section

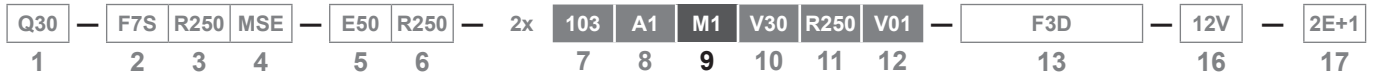

P1-N

Comando pneumatico a tre posizioni con ritorno in pos. 0  
 Three positions pneumatic control spring centred in 0

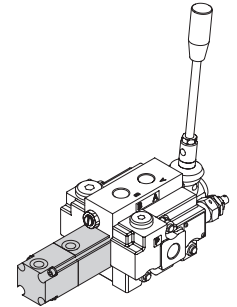
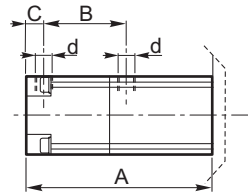

Q30-GSV50 Supporto del comando in Alluminio  
 Q30-GSV50 Command support in aluminium  
 Q80-Q130 Supporto del comando in tecnopolimero  
 Q80-Q130 Command support in technopolimer

	A	B	C	d
Q30 - GSV50	90.5 (3.563)	43 (1.693)	10 (0.394)	G 1/8"
Q80 - Q130	107 (4.213)	48 (1.890)	10.5 (0.413)	

Pressione di pilotaggio / Pilot pressure	Min.	5 bar (72.5 PSI)
	Max.	30 bar (435 PSI)
Volume pilotaggio / Pilot volume	Q30 - GSV50	4 cm <sup>3</sup> (0.244 in <sup>3</sup> )
	Q80 - Q130	9 cm <sup>3</sup> (0.549 in <sup>3</sup> )

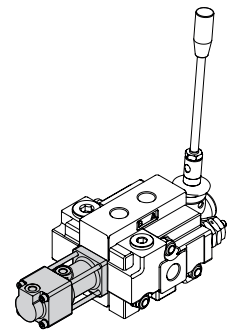

P1-NP

Comando pneumatico progressivo a tre posizioni con ritorno in posizione 0 per azionamento con manipolatore  
 Three positions progressive pneumatic control, spring centred in 0 for remote control

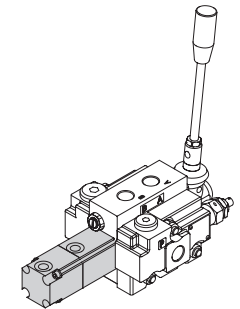
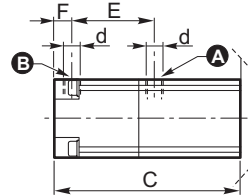

Q30-GSV50 Supporto del comando in Alluminio  
 Q30-GSV50 Command support in aluminium  
 Q80-Q130 Supporto del comando in tecnopolimero  
 Q80-Q130 Command support in technopolimer

	C	E	F	d
Q30 - GSV50	90.5 (3.563)	43 (1.693)	10 (0.394)	G 1/8"
Q80 - Q130	107 (4.213)	48 (1.890)	10.5 (0.413)	

Diagramma pressione di pilotaggio - Corsa spool / Pilot pressure diagram - Spool stroke

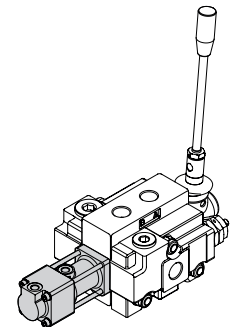
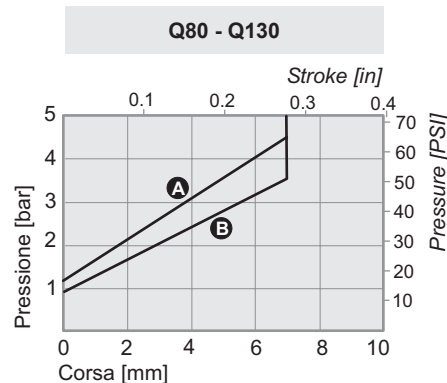
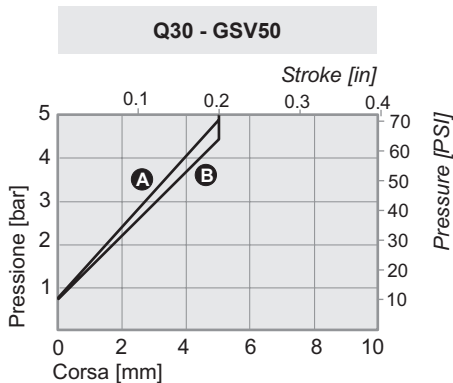

Pressione di pilotaggio / Pilot pressure	Min.	5 bar (72.5 PSI)
	Max.	30 bar (435 PSI)
Volume pilotaggio / Pilot volume	Q30 - GSV50	4 cm <sup>3</sup> (0.244 in <sup>3</sup> )
	Q80 - Q130	9 cm <sup>3</sup> (0.549 in <sup>3</sup> )

Sezione di lavoro e/o elemento intermedio

Working section and/or intermediate section

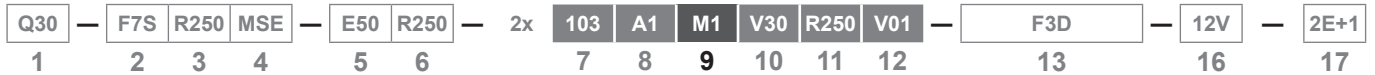

D3

Comando elettropneumatico a tre posizioni con ritorno in pos. 0  
 Three positions electro-pneumatic control spring centred in 0

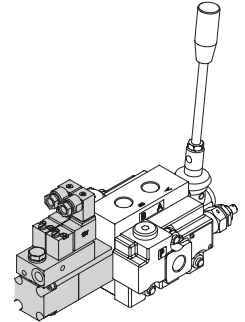
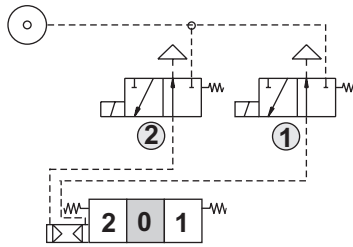

Q30-GSV50 Supporto del comando in Alluminio  
 Q30-GSV50 Command support in aluminium

Q30 - GSV50

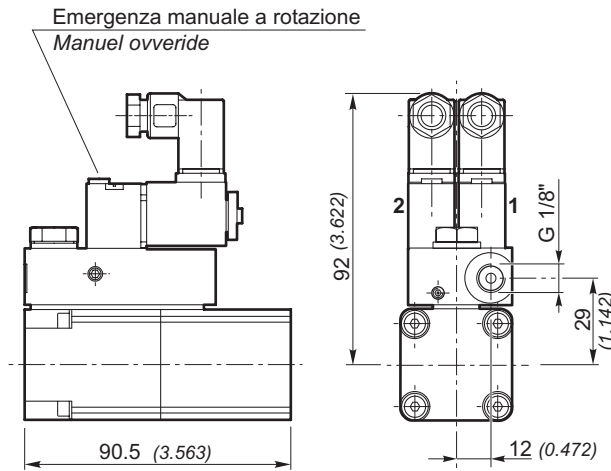

Caratteristiche di funzionamento Operation characteristics	
Pressione di pilotaggio Pilot pressure	1 ÷ 10 bar (14.5 ÷ 145 PSI)
Volume pilotaggio Pilot volume	27NI/ a 6 bar Δpl (27NI/ a 87 PSI Δpl)

Caratteristiche tecniche elettromagnete Electromagnet characteristics	
Tipo attacco magnete Magnet connection type	DIN 175301-803-C
Tipo di protezione Protection type	IP 65
Classe d'isolamento Coil insulation class	F
Tensione di alimentazione Supply voltage	D.C.: 12, 24V A.C.: 50 Hz 230 V
Variazione di tensione max. Maximum voltage tolerance	± 10%
Potenza assorbita Absorbed power supply	D.C.: 2.9 W A.C. 4VA
Rapporto di max. utilizzo Maximum utilization ratio	100%
Temperatura max. Max. temperature	-10 ÷ 50 °C

Q80-Q130 Supporto del comando in tecnopolimero  
 Q80-Q130 Command support in technopolimer

Q80 - Q130

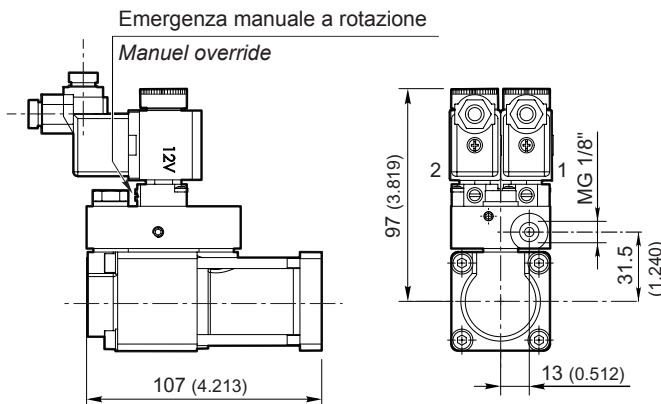

Caratteristiche di funzionamento Operation characteristics	
Pressione di pilotaggio Pilot pressure	1 ÷ 10 bar (14.5 ÷ 145 PSI)
Volume pilotaggio Pilot volume	53NI/ a 6 bar Δpl (53NI/ a 87 PSI Δpl)

Caratteristiche tecniche elettromagnete Electromagnet characteristics	
Tipo attacco magnete Magnet connection type	DIN 43650
Tipo di protezione Protection type	IP 65
Classe d'isolamento Coil insulation class	F
Tensione di alimentazione Supply voltage	D.C.: 12, 24V
Variazione di tensione max. Maximum voltage tolerance	± 10%
Potenza assorbita Absorbed power supply	D.C.: 5 W
Rapporto di max. utilizzo Maximum utilization ratio	100%
Temperatura max. Max. temperature	-10 ÷ 50 °C

## Sezione di lavoro e/o elemento intermedio

## Working section and/or intermediate section

Q30	F7S	R250	MSE	E50	R250	2x	103	H1	V30	R250	V01	F3D	12V	2E+1
1	2	3	4	5	6		7	8	10	11	12	13	16	17

## Comandi completi / Complete controls

			Q30	GSV50	Q80	Q130
H1*	Comando idraulico ad alta pressione ON-OFF a tre posizioni, ritorno a molla in posizione 0	Three positions with high-pressure hydraulic control, spring centered in 0 position	•	•	•	•
H5*	Comando idraulico a bassa pressione per manipolatore idraulico	Low pressure hydraulic control for hydraulic pilot valves	•	•	•	•
RTL-s*	Comando rotativo frizionato a tre posizioni: tacca in pos. 0, leva in pos. 2	3-position clutch-operated rotary control: notch mark in pos. 0, lever in pos. 2	•	•	•	•
RTL-d*	Comando rotativo frizionato a tre posizioni: tacca in pos. 0, leva in pos. 1	3-position clutch-operated rotary control: detent in pos. 0, lever in pos. 1	•	•	•	•
C2*	Comando a camme 2 posizioni estreme 1-2, ritorno a molla in pos. 1	Cam control, 2 end positions 1-2, spring centered in 1 position	•	•	•	•
C3*	Comando a camme 2 posizioni estreme 2-1, ritorno a molla in pos. 2	Cam control, 2 end positions 2-1, spring centered in 2 position	•	•	•	•
A1/D41*	Comando elettrico diretto doppio, ritorno a molla in pos. 0	Double direct electrical control with spring centred in 0	•	•	•	
A2/D41*	Comando elettrico diretto doppio con leva ruotata, ritorno a molla in pos. 0	180° rotated double direct electrical control with spring centred in 0	•	•	•	
A1/DP*	Comando elettrico diretto doppio, ritorno a molla in pos. 0	Double direct electrical control with spring centred in 0	•	•	•	
A2/DP*	Comando elettrico diretto doppio, ritorno a molla in pos. 0	Double direct electrical control with spring centred in 0	•	•	•	
D9*	Comando elettrico diretto a due magneti con ritorno a molla in pos. 0	Double direct electrical control with spring centred in 0	•	•	•	
H7	Comando elettroidraulico proporzionale lato doppio	Electrohydraulic proportional control double side				•
A1/H7	Comando elettroidraulico proporzionale lato doppio con leva di emergenza	Electrohydraulic proportional control double side with emergency lever				•

## \* Limitazioni / Limitations

Comando completo Complete control	Applicabile con: / Applicable with:	
	Cursore / Spool	Valvole / Valves
H1	Tutti tranne / All except 116 / 126	Tutte le valvole a cartuccia e tutte le valvole a pannello  All cartridges and panel valves
H5		
RTL-s		
RTL-d		
C2		
C3		
A1/D41		
A2/D41		
A1/DP		
A2/DP		
D9	101 / 102 / 103 / 107 / 108 / 109 / 110 / 111	

Sezione di lavoro e/o elemento intermedio

Working section and/or intermediate section



H1

Comando idraulico ad alta pressione ON-OFF a tre posizioni, ritorno a molla in posizione 0  
 Three positions whit high-pressure hydraulic control, spring centred in 0 position

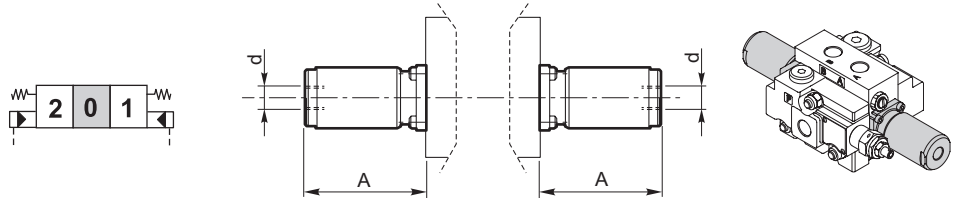

	A	d
Q30 - GSV50	70 (2.756)	G 1/4
Q80 - Q130	85 (3.346)	

Pressione di pilotaggio / Pilot pressure	Min.	16 bar (232 PSI)
	Max.	350 bar (5075 PSI)
Volume pilotaggio / Pilot volume	Q30- GSV50	2 cm <sup>3</sup> (0.122 in <sup>3</sup> )
	Q80-Q130	3 cm <sup>3</sup> (0.183 in <sup>3</sup> )

H5

Comando idraulico a bassa pressione a tre posizioni per manipolatore idraulico, ritorno a molla in posizione 0  
 Three positions whit low-pressure hydraulic control for hydraulic remote control, spring centred in 0 position

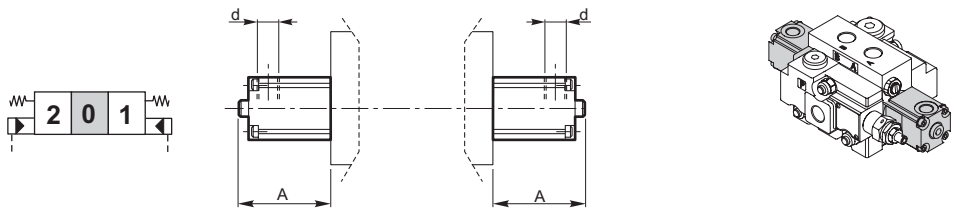

	A	d
Q30 - GSV50	50 (1.969)	G 1/4
Q80 - Q130	71.5 (2.815)	

Montare le rondelle di tenuta sotto il raccordo.  
 Mount the sealing washer under the nipple.

Diagramma pressione di pilotaggio - Corsa spool / Pilot pressure diagram - Spool stroke

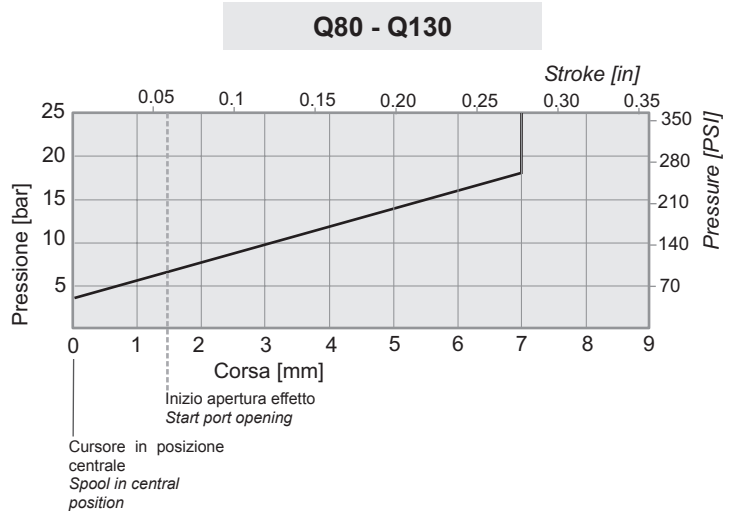
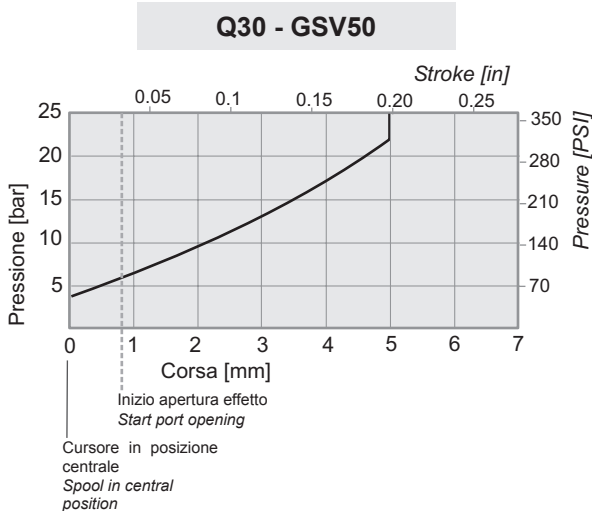

Pressione di pilotaggio / Pilot pressure	Max.	100 bar (1450 PSI)
Volume pilotaggio / Pilot volume	Q30-GSV50	1 cm <sup>3</sup> (0.061 in <sup>3</sup> )
	Q80-Q130	2 cm <sup>3</sup> (0.122 in <sup>3</sup> )

N.B. Le curve sono ricavate con cursore 103  
 NOTE. Performance curves measured using spool 103 type.

Sezione di lavoro e/o elemento intermedio

Working section and/or intermediate section

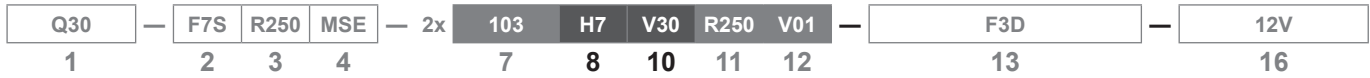

H7

Comando elettroidraulico proporzionale lato doppio  
Electrohydraulic proportional control double side



Diagramma corrente-corsa cursore  
Current – spool stroke diagram



Caratteristiche elettriche / Electrical Characteristic

Tipo di attacco / Plug connector	AMP junior-Timer *
Grado di protezione / Protection rating	IP 65
Classe di isolamento / Insulation class	F
Tensione di alimentazione / Supply voltage	12V,24V D.C.
Corrente massima / Max current	1.5A @ 12V - 0.75A @ 24V
Frequenza PWM / PWM frequency	100Hz
Rapporto di inserzione / Insertion ratio ED	100%
Limiti di temperatura / Temperature range	-20°C +80°C
Isteresi massima / Max hysteresis	20%

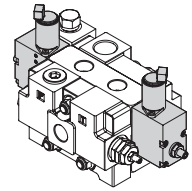
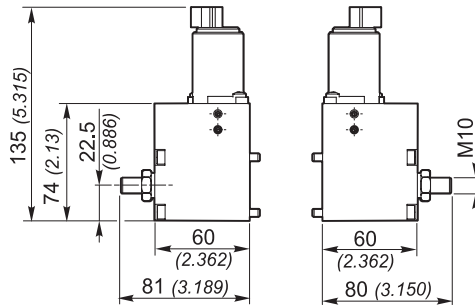
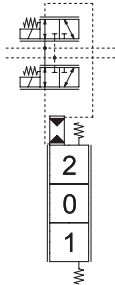
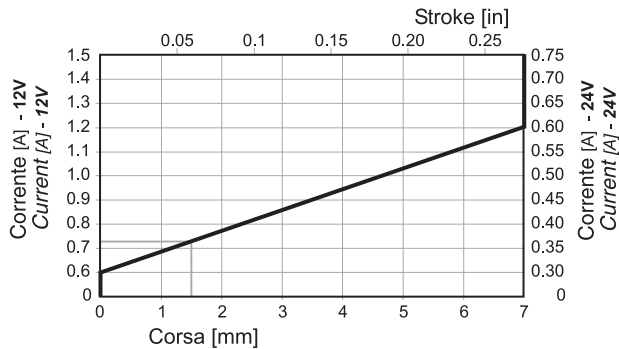
\* Connettore Deutsch disponibile su richiesta / Deutsch connector available on request

A1/H7

Comando elettroidraulico proporzionale lato doppio con leva di emergenza  
Electrohydraulic proportional control double side with emergency lever



Diagramma corrente-corsa cursore  
Current – spool stroke diagram



Caratteristiche elettriche / Electrical Characteristic

Tipo di attacco / Plug connector	AMP junior-Timer *
Grado di protezione / Protection rating	IP 65
Classe di isolamento / Insulation class	F
Tensione di alimentazione / Supply voltage	12V,24V D.C.
Corrente massima / Max current	1.5A @ 12V - 0.75A @ 24V
Frequenza PWM / PWM frequency	100Hz
Rapporto di inserzione / Insertion ratio ED	100%
Limiti di temperatura / Temperature range	-20°C +80°C
Isteresi massima / Max hysteresis	20%

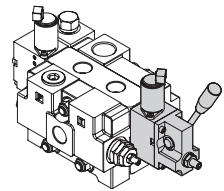
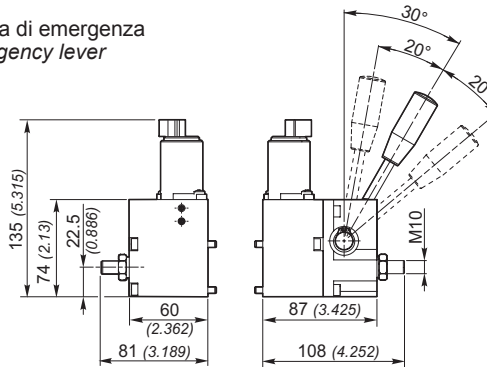
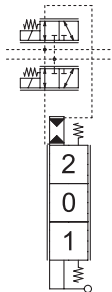
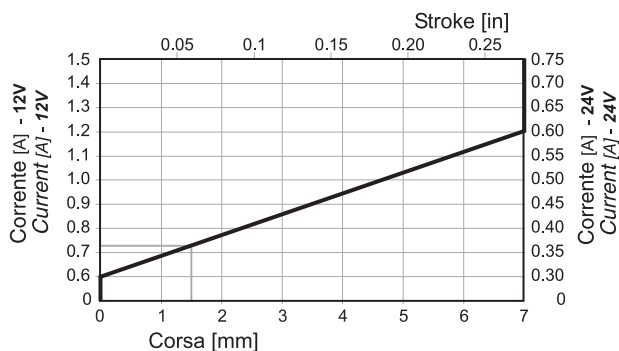
\* Connettore Deutsch disponibile su richiesta / Deutsch connector available on request



Sezione di lavoro e/o elemento intermedio

Working section and/or intermediate section



**RTL-s**

Tre posizioni con comando rotativo frizionato, tacca in pos. 0, leva in pos. 2  
 Three positions with rotary control, lever in 2 position

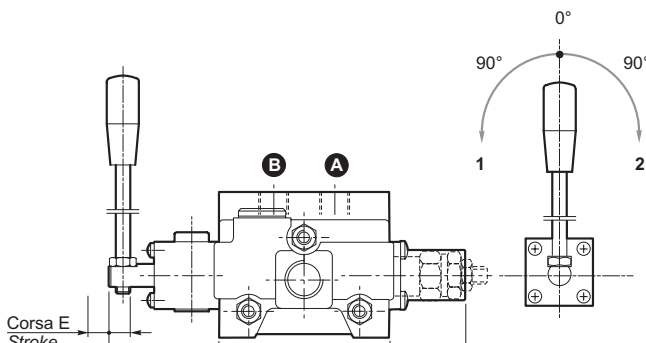

	C	D	E
<b>Q30 - GSV50</b>	42 (1.654)	61 (2.402)	10 (5+5) 0.394 (0.197+0.197)
<b>Q80 - Q130</b>	55 (2.165)	72.5 (2.854)	14 (7+7) 0.551 (0.276+ 0.276)

**RTL-d**

Tre posizioni con comando rotativo frizionato, tacca in pos. 0, leva in pos. 1  
 Three positions with duced rotary control, lever in 1 position

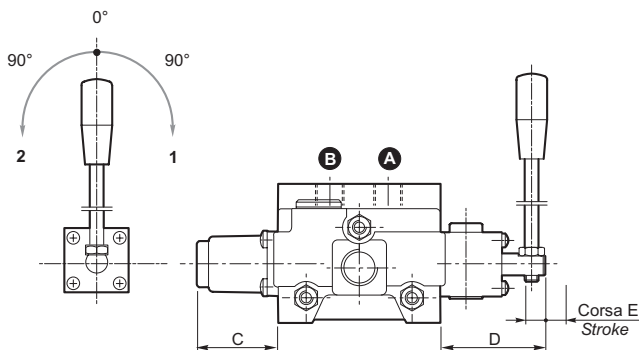
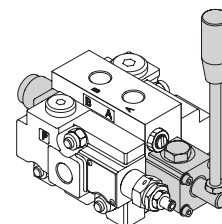
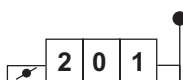

	C	D	E
<b>Q30 - GSV50</b>	42 (1.654)	61 (2.402)	10 (5+5) 0.394 (0.197+0.197)
<b>Q80 - Q130</b>	55 (2.165)	72.5 (2.854)	14 (7+7) 0.551 (0.276+ 0.276)

Sezione di lavoro e/o elemento intermedio

Working section and/or intermediate section



**C2**

Comando a camme 2 posizioni estreme 1-2, con ritorno a molla in pos. 1  
 Cam control, 2 end positions 1-2, spring centred in 1 position

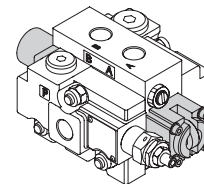
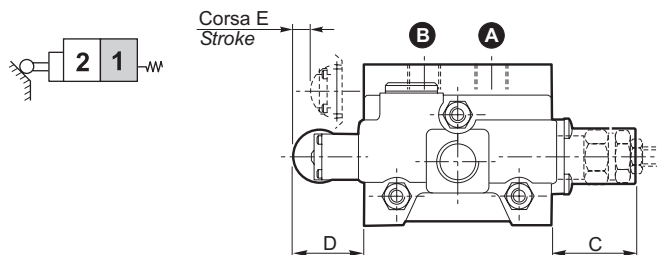

	C	D	E
<b>Q30 - GSV50</b>	42 (1.654)	43 (1.693)	10 (0.394)
<b>Q80 - Q130</b>	55 (2.165)	51 (2.008)	14 (0.551)

**C3**

Comando a camme, 2 posizioni estreme 2-1, con ritorno a molla in pos. 2  
 Cam control, 2 end positions 2-1, spring centred in 2 position

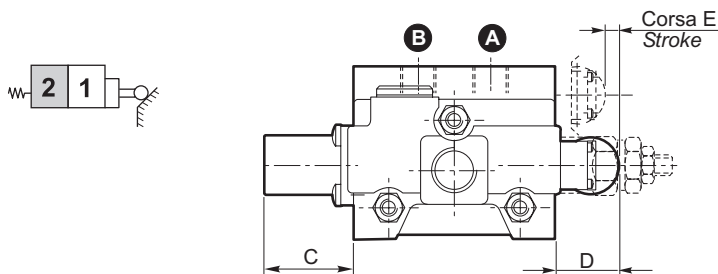

	C	D	E
<b>Q30 - GSV50</b>	42 (1.654)	43 (1.693)	10 (0.394)
<b>Q80 - Q130</b>	55 (2.165)	51 (2.008)	14 (0.551)

Sezione di lavoro e/o elemento intermedio

Working section and/or intermediate section

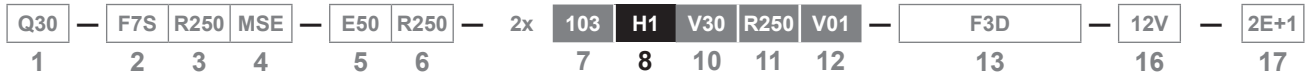

**A1/D41**

Comando elettrico diretto doppio ON/OFF con ritorno a molla in posizione 0  
 ON/OFF double direct electrical control with spring centred in 0

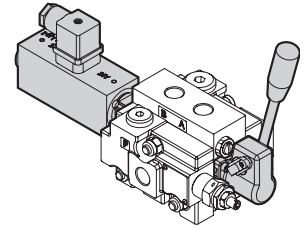

**A2/D41**

Comando elettrico diretto doppio ON/OFF ruotato di 180° con ritorno a molla in posizione 0  
 180° rotated ON/OFF double direct electrical control with spring centred in 0

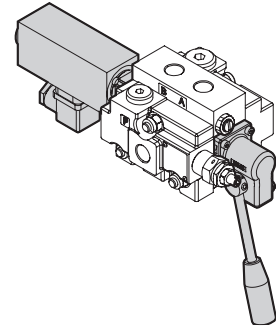
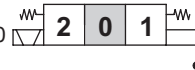

Connessione Connection		
	1 - 2	Effetto A Port A
	1 - 3	Effetto B Port B

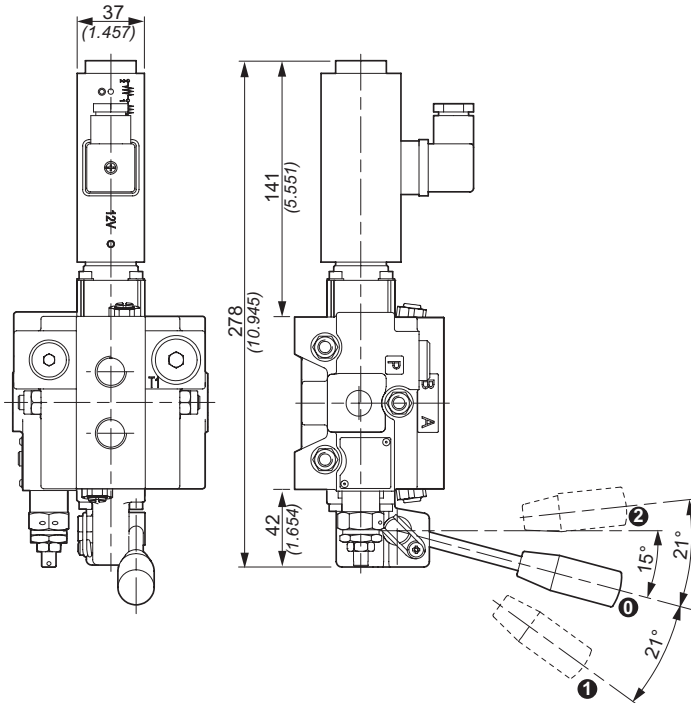

Dimensioni in / Dimensions in: mm (inch)

Caratteristiche tecniche elettromagnete / Electromagnet technical features		
Tipo distributore / Valve type	<b>Q30</b>	<b>GSV50</b>
Attacco magnete / Magnet connection	Tipo/Type DIN 43650 (vers. A)	
Tipo protezione / Protection type	IP65	
Classe d'isolamento / Coil insulation class	H	
Tensione di alimentazione / Supply voltage	12V D.C./24V D.C.	
Variazione di tensione max / Maximum voltage tolerance	±10%	
Potenza assorbita / Absorbed power supply	58W	
Rapporto di massimo utilizzo / Maximum utilization ratio	100%	
Caratteristiche tecniche distributore / Directional control valve characteristics		
Portata max (lt/min) / Max. flow (Gal/min)	50 (13)	60 (16)
Pressione max di lavoro / Max. working pressure	275 bar (3988 PSI)	
Contropressione max sullo scarico / Max. back outlet pressure	25 bar (3363 PSI)	
Manovra di emergenza o in assenza di corrente / Emergency operation or in case of power failure	Con leva / With lever	
Trafilamento max di A e B in T a 100 bar con viscosità 35 mm <sup>2</sup> /s Max. spool leakage of A and B ports to T port at 1450 PSI with viscosity 35 mm <sup>2</sup> /s	5 cm <sup>3</sup> /min	

Sezione di lavoro e/o elemento intermedio

Working section and/or intermediate section

Limiti d'impiego / Use limits

Perdite di carico con il cursore in posizione neutra

( $\Delta p$  in funzione del numero di sezioni attraversate)

Pressure drop with spool in neutral position

( $\Delta p$  depending on the number of the crossed sections)

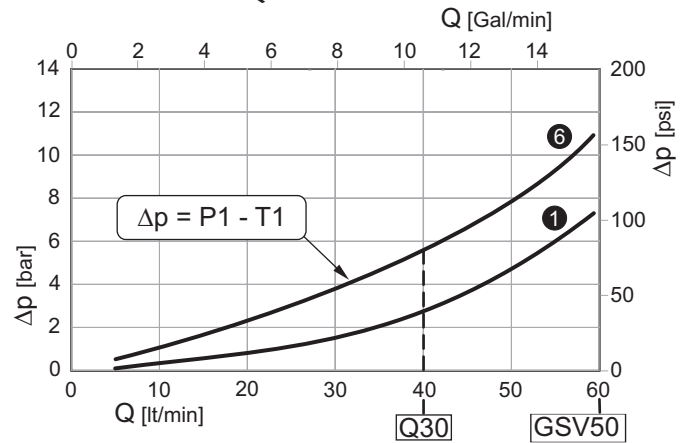
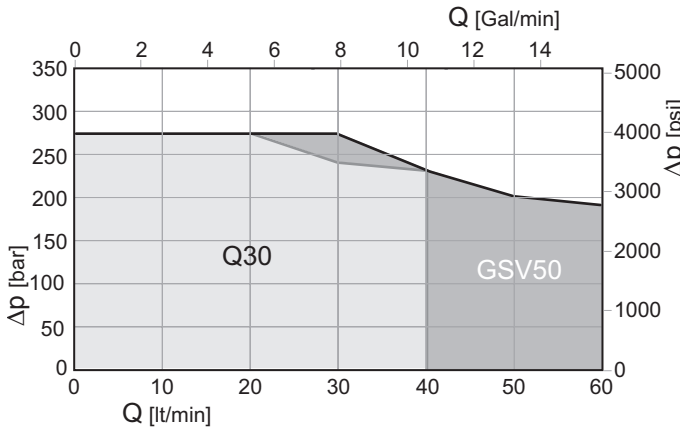
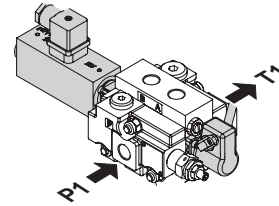

Perdite di carico con il cursore in posizione di lavoro

( $\Delta p$  in funzione del numero di sezioni attraversate)

Pressure drop with spool in working position

( $\Delta p$  depending on the number of the crossed sections)

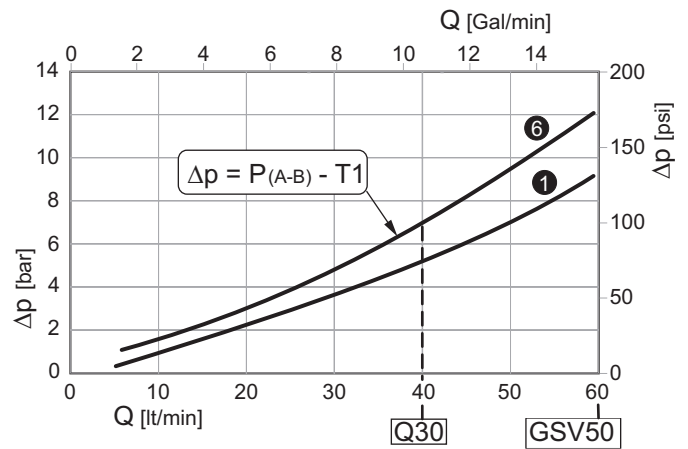
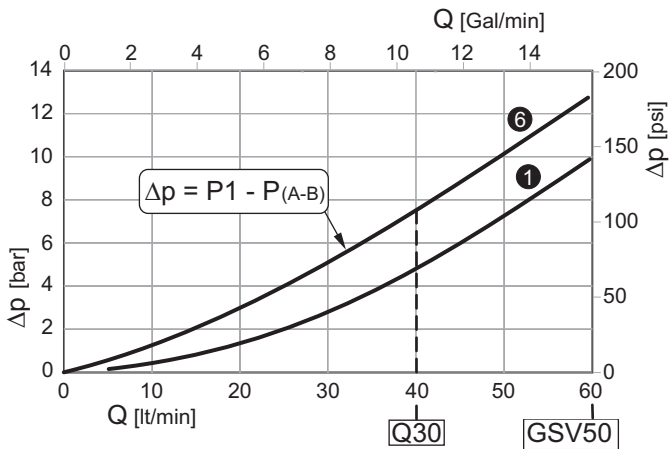
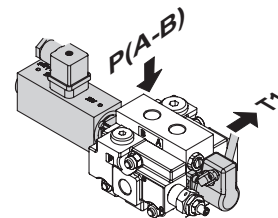
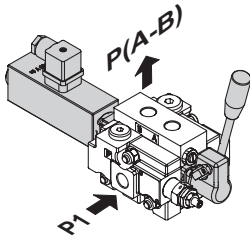

1 6 Sezioni / Sections

Sezione di lavoro e/o elemento intermedio

Working section and/or intermediate section

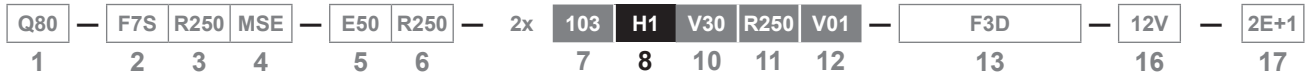

**A1/D41**

Comando elettrico diretto doppio e ritorno a molla in posizione 0  
 Double direct electrical control with spring centred in 0

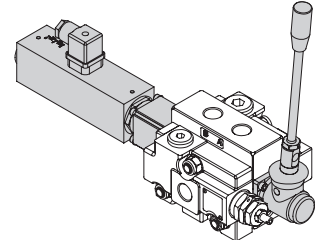

**A2/D41**

Comando elettrico diretto doppio ON/OFF ruotato di 180° e ritorno a molla in posizione 0  
 180° rotated ON/OFF double direct electrical control with spring centred in 0

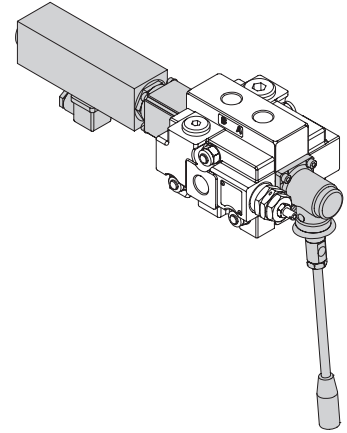

Connessione Connection		
	1 - 2	Effetto A Port A
	1 - 3	Effetto B Port B

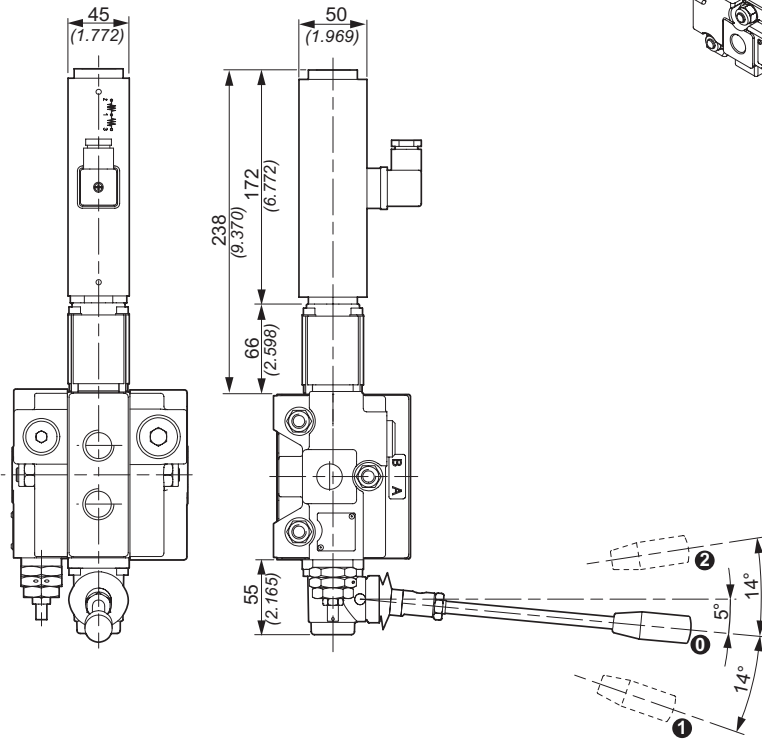

Dimensioni in / Dimensions in: mm (inch)

Caratteristiche tecniche elettromagnete / Electromagnet technical features	
Tipo distributore / Valve type	<b>Q80</b>
Attacco magnete / Magnet connection	Tipo/Type DIN 43650 (vers. A)
Tipo protezione / Protection type	IP65
Classe d'isolamento / Coil insulation class	H
Tensione di alimentazione / Supply voltage	12V D.C./24V D.C.
Variazione di tensione max / Maximum voltage tolerance	±10%
Potenza assorbita / Absorbed power supply	80W
Rapporto di massimo utilizzo / Maximum utilization ratio	100%
Caratteristiche tecniche distributore / Directional control valve characteristics	
Portata max (lt/min) / Max. flow (Gal/min)	90 (24)
Pressione max di lavoro / Max. working pressure	300 bar
Contropressione max sullo scarico / Max. back outlet pressure	25 bar
Manovra di emergenza o in assenza di corrente / Emergency operation or in case of power failure	Con leva / With lever
Trafilamento max di A e B in T a 100 bar con viscosità 35 mm <sup>2</sup> /s Max. spool leakage of A and B ports to T port at 1450 bar with viscosity 35 mm <sup>2</sup> /s	5 cm <sup>3</sup> /min

**Sezione di lavoro e/o elemento intermedio**

**Working section and/or intermediate section**

**Limiti d'impiego / Use limits**

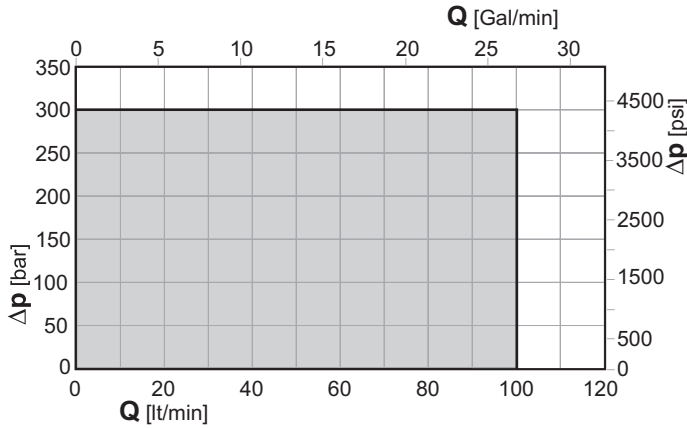

**Perdite di carico con il cursore in posizione neutra**

( $\Delta p$  in funzione del numero di sezioni attraversate)

**Pressure drop with spool in neutral position**

( $\Delta p$  depending on the number of the crossed sections)

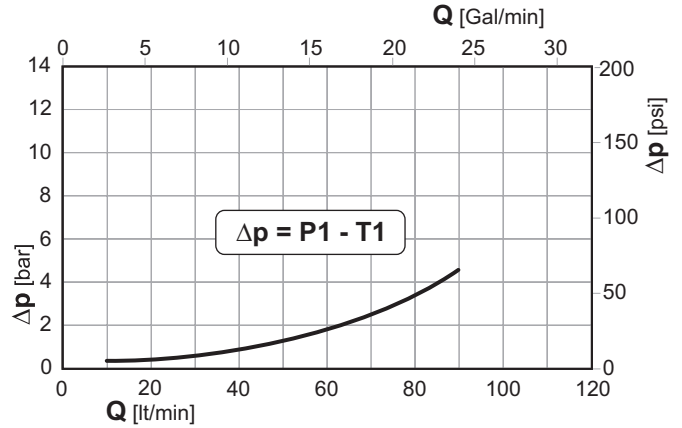
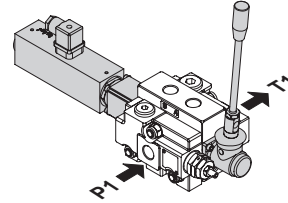

**Perdite di carico con il cursore in posizione di lavoro**

( $\Delta p$  in funzione del numero di sezioni attraversate)

**Pressure drop with spool in working position**

( $\Delta p$  depending on the number of the crossed sections)

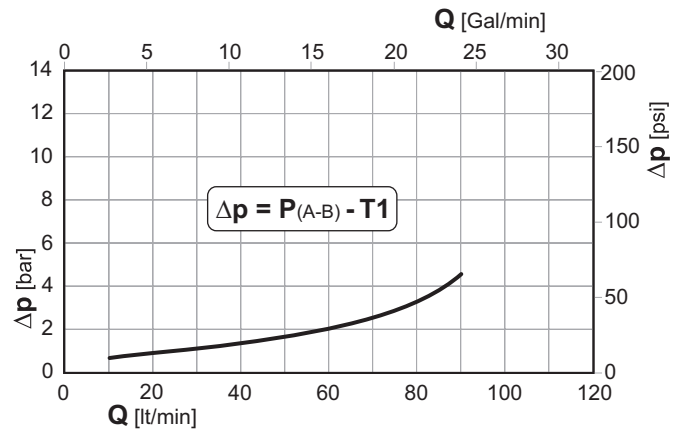
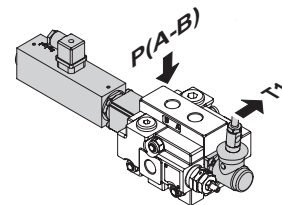
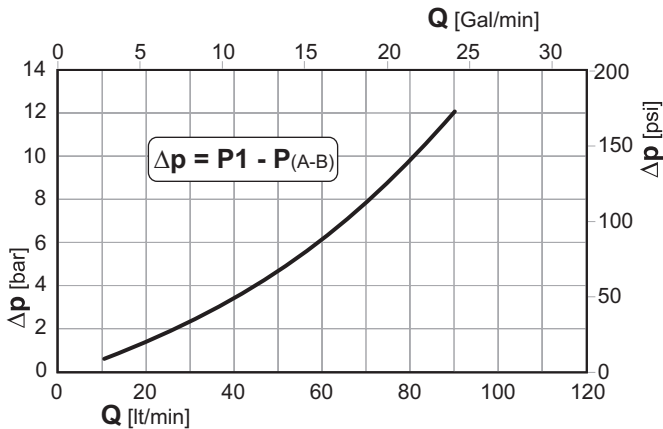
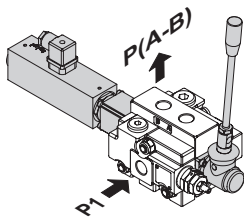

N.B. Le curve sono ricavate con cursore 103 / NOTE. Performance curves measured using spool 103 type.

Sezione di lavoro e/o elemento intermedio

Working section and/or intermediate section

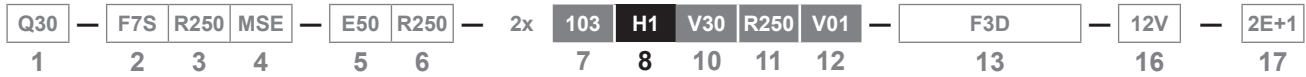

**A1/DP**

Comando elettrico diretto doppio con magnete proporzionale e ritorno a molla in posizione 0  
*Double direct electrical control with proportional solenoid and spring centred in 0*

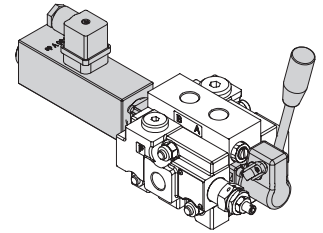
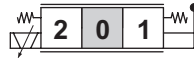

**A2/DP**

Comando elettrico diretto doppio con magnete proporzionale ruotato di 180° e ritorno a molla in posizione 0  
*180° rotated double direct electrical control with proportional solenoid and spring centred in 0*

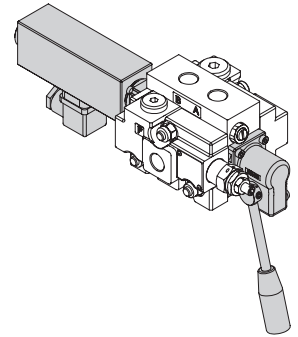

Connessione Connection		
	1 - 2	Effetto A Port A
	1 - 3	Effetto B Port B

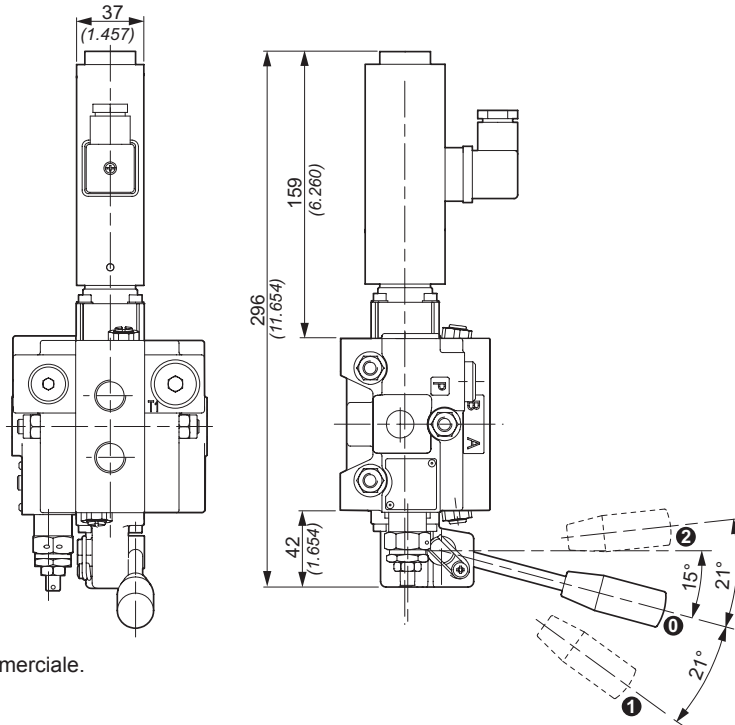

Per l'elettronica di comando contattare l'ufficio commerciale.  
*For electronic control unit contact the sales office.*

Dimensioni in / Dimensions in: mm (inch)

Caratteristiche tecniche elettromagnete / Electromagnet technical features		
Tipo distributore / Valve type	<b>Q30</b>	<b>GSV50</b>
Attacco magnete / Magnet connection	Tipo/Type DIN 43650 (vers. A)	
Tipo protezione / Protection type	IP65	
Classe d'isolamento / Coil insulation class	H	
Tensione di alimentazione / Supply voltage	12 VDC	24 VDC
Corrente di regolazione massima / Current maximum range	5 A	2.5 A
PWM frequency	100 Hz	
Caratteristiche tecniche distributore / Directional control valve characteristics		
Portata max (lt/min) / Max. flow (Gal/min)	50 (13)	60 (16)
Pressione max di lavoro / Max. working pressure	250 bar	
Contropressione max sullo scarico / Max. back outlet pressure	25 bar	
Manovra di emergenza o in assenza di corrente / Emergency operation or in case of power failure	Con leva / With lever	
Trafilamento max di A e B in T a 100 bar con viscosità 35 mm <sup>2</sup> /s Max. spool leakage of A and B ports to T port at 1450 bar with viscosity 35 mm <sup>2</sup> /s	5 cm <sup>3</sup> /min	

Sezione di lavoro e/o elemento intermedio

Working section and/or intermediate section

Limiti d'impiego / Use limits

Perdite di carico con il cursore in posizione neutra

( $\Delta p$  in funzione del numero di sezioni attraversate)

Pressure drop with spool in neutral position

( $\Delta p$  depending on the number of the crossed sections)

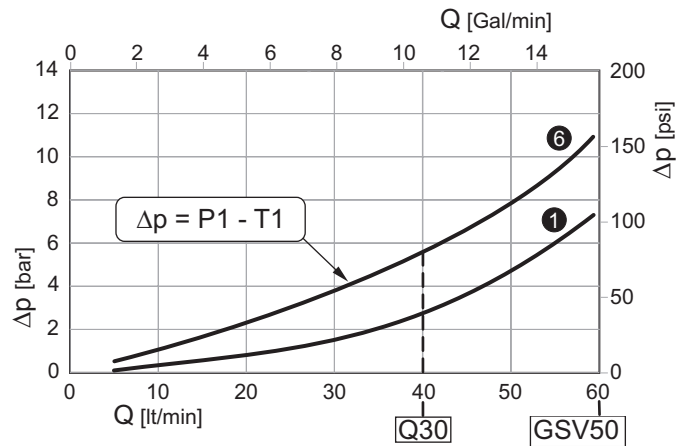
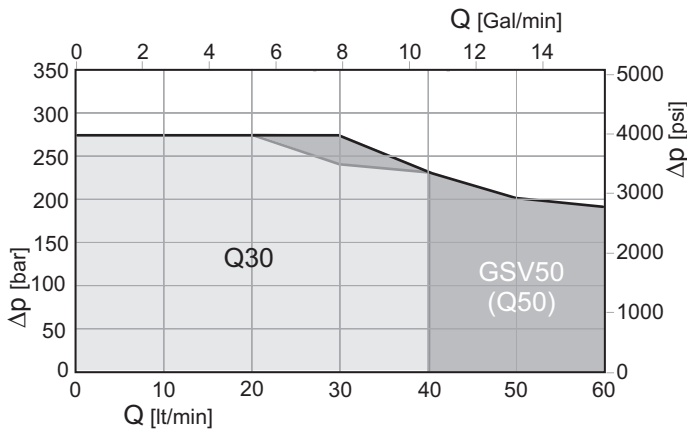
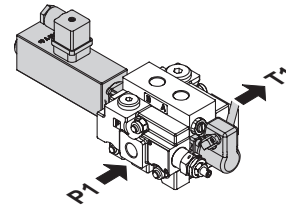

N.B. Le curve sono ricavate con cursore 103 / NOTE: Performance curves measured using spool 103 type.

1 6 Sezioni / Sections

Curve di metering corrente bassa portata  $Q_{in}$  30 l/min  
Metering curve current low delivery  $Q_{in}$  30 l/min

Curve di metering corrente bassa portata  $Q_{in}$  60 l/min  
Metering curve current low delivery  $Q_{in}$  60 l/min

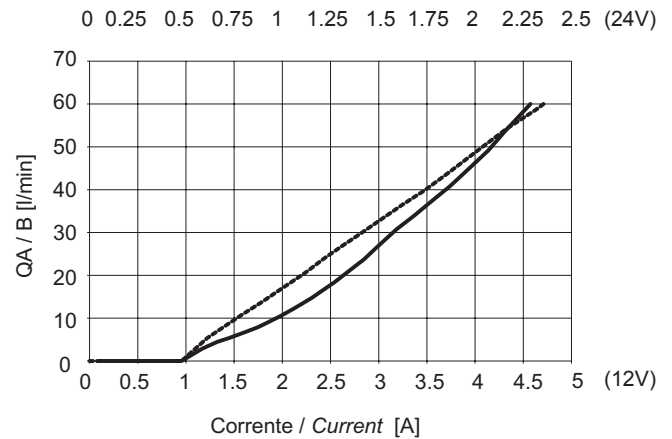
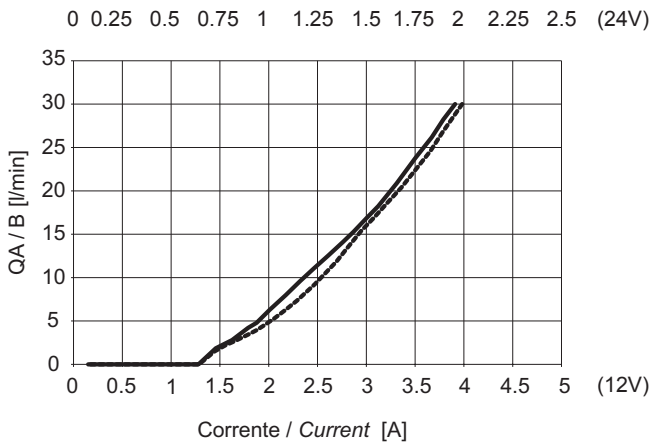

--- Cursore 111 / Spool 111 type  
— Cursore 103 / Spool 103 type



Sezione di lavoro e/o elemento intermedio

Working section and/or intermediate section

Q30	F7S	R250	MSE	E50	R250	2x	103	H1	V30	R250	V01	F3D	12V	2E+1
1	2	3	4	5	6		7	8	10	11	12	13	16	17

D9

Comando elettrico diretto doppio ON/OFF con ritorno a molla in posizione 0  
 ON/OFF double direct electrical control with spring centred in 0

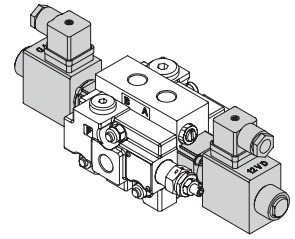
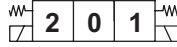

Connessione Connection		
	1 - 2	Effetto A Port A
	1 - 3	Effetto B Port B

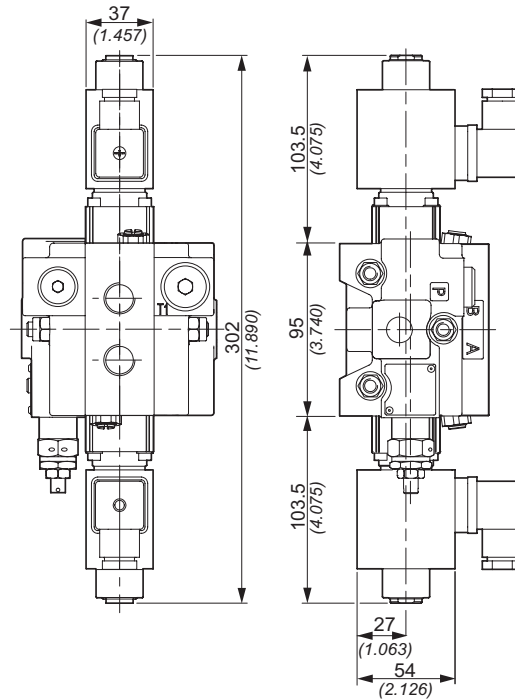

Dimensioni in / Dimensions in: mm (inch)

Caratteristiche tecniche elettromagnete / Electromagnet technical features		
Tipo distributore / Valve type	Q30	GSV50
Attacco magnete / Magnet connection	Tipo/Type DIN 43650 (vers. A)	
Tipo protezione / Protection type	IP65	
Classe d'isolamento / Coil insulation class	H	
Tensione di alimentazione / Supply voltage	12V D.C./24V D.C.	
Variazione di tensione max / Maximum voltage tolerance	±10%	
Potenza assorbita / Absorbed power supply	58W	
Rapporto di massimo utilizzo / Maximum utilization ratio	100%	
Caratteristiche tecniche distributore / Directional control valve characteristics		
Portata max / Max. flow	50	60
Pressione max di lavoro / Max. working pressure	275 bar	
Contropressione max sullo scarico / Max. back outlet pressure	25 bar	
Manovra di emergenza o in assenza di corrente / Emergency operation or in case of power failure	A pulsante in spinta / Push type	
Trafilamento max di A e B in T a 100 bar con viscosità 35 mm <sup>2</sup> /s / Max. spool leakage of A and B ports to T port at 100 bar with viscosity 35 mm <sup>2</sup> /s	5 cm <sup>3</sup> /min	

Sezione di lavoro e/o elemento intermedio

Working section and/or intermediate section

Limiti d'impiego / Use limits

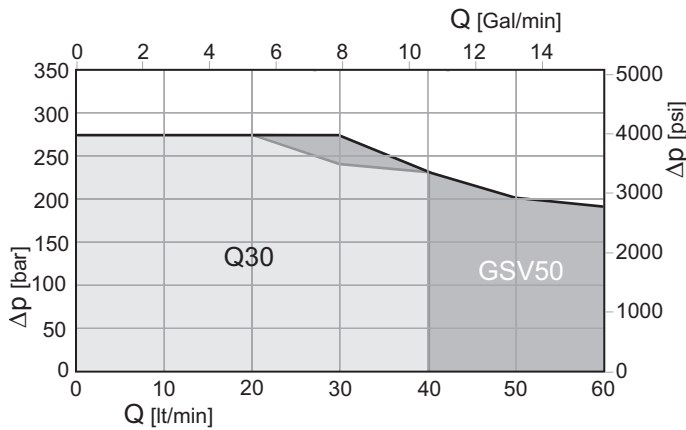

Perdite di carico con il cursore in posizione neutra

( $\Delta p$  in funzione del numero di sezioni attraversate)

Pressure drop with spool in neutral position

( $\Delta p$  depending on the number of the crossed sections)

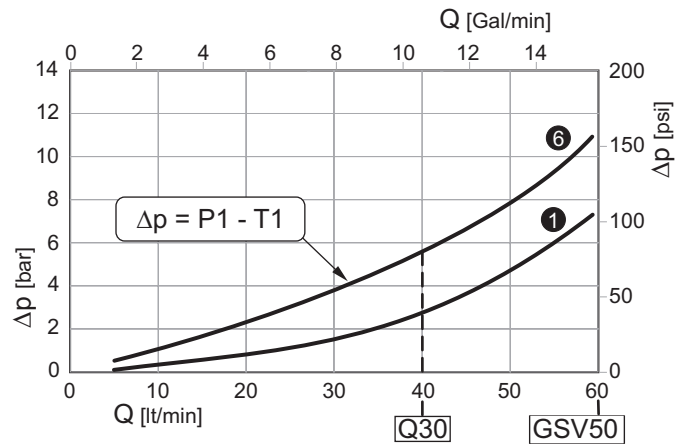
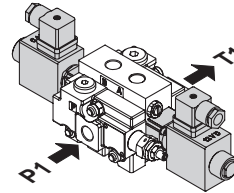

Perdite di carico con il cursore in posizione di lavoro

( $\Delta p$  in funzione del numero di sezioni attraversate)

Pressure drop with spool in working position

( $\Delta p$  depending on the number of the crossed sections)

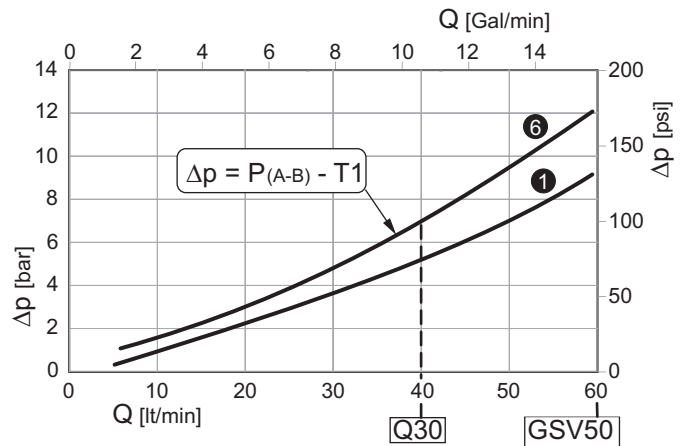
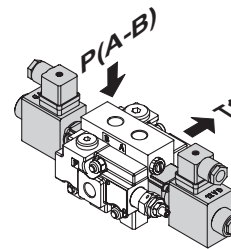
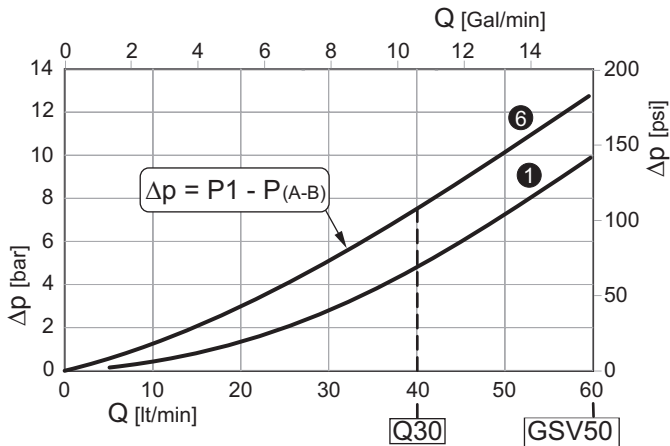
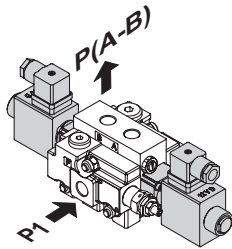

1 6 Sezioni / Sections

Sezione di lavoro e/o elemento intermedio

Working section and/or intermediate section

Q80	F7S	R250	MSE	E50	R250	2x	103	A1	M1	V30	R250	V01	F3D	12V	2E+1
1	2	3	4	5	6		7	8	9	10	11	12	13	16	17

D9

Comando elettrico diretto doppio ON/OFF con ritorno a molla in posizione 0  
 ON/OFF double direct electrical control with spring centred in 0

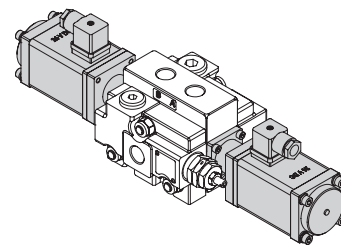
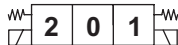

Connessione Connection		
	1 - 2	Effetto A Port A
	1 - 3	Effetto B Port B

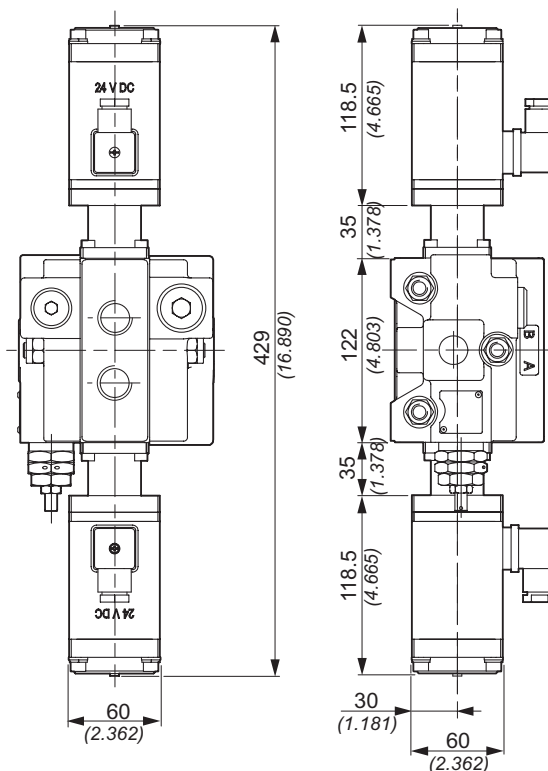

**Nota:**  
 Per 2 o più sezioni di lavoro, aggiungere elemento intermedio cod E61 (spessore) tra due sezioni contigue.

**Note:**  
 For 2 or more sections, should add the intermediate element code E61 (thickness 46) between the 2 sections.

Dimensioni in / Dimensions in: mm (inch)

Caratteristiche tecniche elettromagnete / Electromagnet technical features	
Tipo distributore / Valve type	<b>Q80</b>
Attacco magnete / Magnet connection	Tipo/Type DIN 43650 (vers. A)
Tipo protezione / Protection type	IP65
Classe d'isolamento / Coil insulation class	H
Tensione di alimentazione / Supply voltage	12V D.C./24V D.C.
Variazione di tensione max / Maximum voltage tolerance	±10%
Potenza assorbita / Absorbed power supply	80W
Rapporto di massimo utilizzo / Maximum utilization ratio	100%
Caratteristiche tecniche distributore / Directional control valve characteristics	
Portata max / Max. flow	90      120
Pressione max di lavoro / Max. working pressure	210 bar
Contropressione max sullo scarico / Max. back outlet pressure	25 bar
Manovra di emergenza o in assenza di corrente / Emergency operation or in case of power failure	A pulsante in spinta / Push type
Trafilamento max di A e B in T a 100 bar con viscosità 35 mm <sup>2</sup> /s / Max. spool leakage of A and B ports to T port at 100 bar with viscosity 35 mm <sup>2</sup> /s	7 cm <sup>3</sup> /min

Sezione di lavoro e/o elemento intermedio

Working section and/or intermediate section

Limiti d'impiego / Use limits

Perdite di carico con il cursore in posizione neutra

( $\Delta p$  in funzione del numero di sezioni attraversate)  
**Pressure drop with spool in neutral position**  
 ( $\Delta p$  depending on the number of the crossed sections)

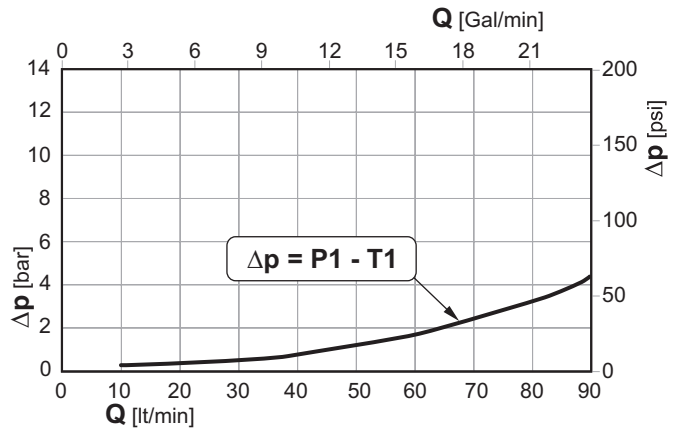
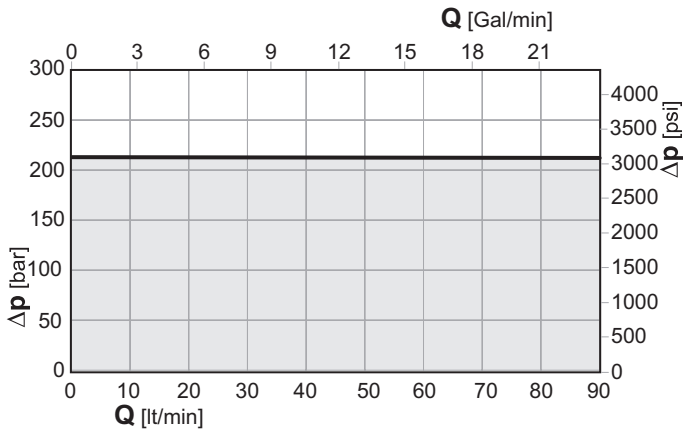
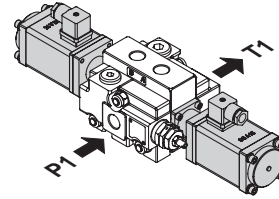

Perdite di carico con il cursore in posizione di lavoro

( $\Delta p$  in funzione del numero di sezioni attraversate)  
**Pressure drop with spool in working position**  
 ( $\Delta p$  depending on the number of the crossed sections)

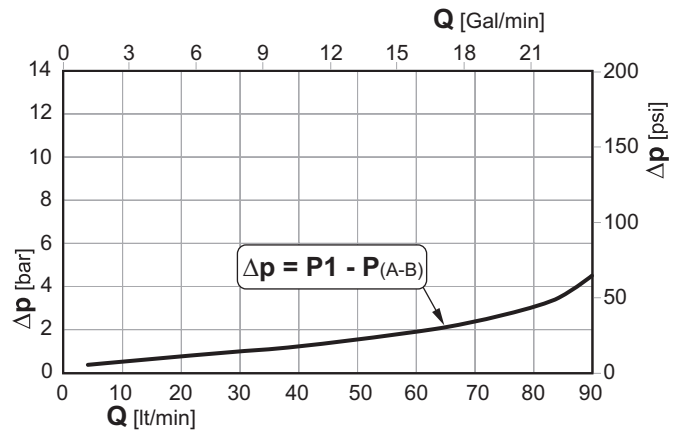
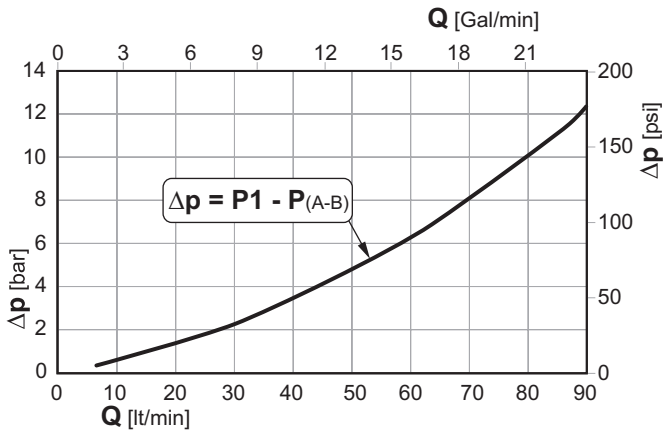
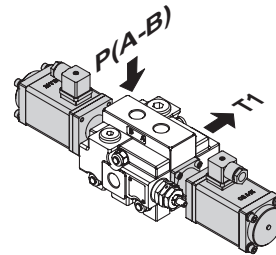
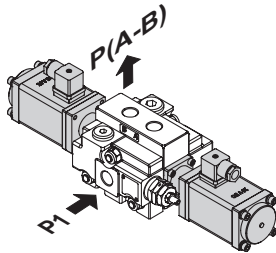

N.B. Le curve sono ricavate con cursore 103 / NOTE. Performance curves measured using spool 103 type.

Sezione di lavoro e/o elemento intermedio

Working section and/or intermediate section

Q30	F7S	R250	MSE	E50	R250	2x	103	A1	M1	V30	R250	V01	F3D	12V	2E+1
1	2	3	4	5	6		7	8	9	10	11	12	13	16	17

10 - Tipo valvole a cartuccia / Type of built-in cartridge valves

		Q30	GSV50	Q80	Q130
<b>VC</b>	Tappo di chiusura per corpo distributore predisposto per valvole antiurto e/o anticavitazione	•	•	•	•
<b>V30</b>	Valvola limitatrice di pressione (o antiurto), registrabile, su effetto A (per le tarature vedere par. 11)	•	•	•	•
<b>V31</b>	Valvola limitatrice di pressione (o antiurto), registrabile, su effetto B (per le tarature vedere par. 11)	•	•	•	•
<b>V32</b>	Valvola limitatrice di pressione (o antiurto), registrabile, su effetto A e B (per le tarature vedere par. 11)	•	•	•	•
<b>V33</b>	Valvola limitatrice di pressione (o antiurto), registrabile, con anticavitazione, su effetto A (per le tarature vedere par. 11)	•	•	•	•
<b>V34</b>	Valvola limitatrice di pressione (o antiurto), registrabile, con anticavitazione, su effetto B (per le tarature vedere par. 11)	•	•	•	•
<b>V35</b>	Valvola limitatrice di pressione (o antiurto), registrabile, con anticavitazione, su effetto A e B (per le tarature vedere par. 11)	•	•	•	•
<b>V40</b>	Valvola limitatrice di pressione (o antiurto), registrabile su effetto A e anticavitazione su effetto B (per le tarature vedere par. 11)	•	•	•	•
<b>V41</b>	Valvola anticavitazione su effetto A e valvola limitatrice di pressione (o antiurto), registrabile su effetto B (per le tarature vedere par. 11)	•	•	•	•
<b>V04</b>	Valvola anticavitazione su effetto A	•	•	•	•
<b>V05</b>	Valvola anticavitazione su effetto B	•	•	•	•
<b>V06</b>	Valvola anticavitazione doppia su effetti A e B	•	•	•	•

**VC**

Tappo di chiusura per corpo distributore predisposto per valvole antiurto e/o anticavitazione. *Closing plug for directional control valve body preset for shock and/or anticavitation valves.*

**V32**

Valvola limitatrice di pressione (o antiurto), registrabile, su effetto A e B (per le tarature vedere pagina seguente). *Pressure limiting valve (or antishock), adjustable, on A and B port (for the setting see next page).*

**V30**

Valvola limitatrice di pressione (o antiurto), registrabile, su effetto A (per le tarature vedere pagina seguente). *Pressure limiting valve (or antishock), adjustable, on A port (for the setting see next page).*

**V33**

Valvola limitatrice di pressione (o antiurto), registrabile, con anticavitazione, su effetto A (per le tarature vedere pagina seguente). *Pressure limiting valve (or antishock), adjustable, with anticavitation, on A port (for the setting see next page).*

**V31**

Valvola limitatrice di pressione (o antiurto), registrabile, su effetto B (per le tarature vedere pagina seguente). *Pressure limiting valve (or antishock), adjustable, on B port (for the setting see next page).*

**V34**

Valvola limitatrice di pressione (o antiurto), registrabile, con anticavitazione, su effetto B (per le tarature vedere pagina seguente). *Pressure limiting valve (or antishock), adjustable, with anticavitation, on B port (for the setting see next page).*

**Sezione di lavoro e/o elemento intermedio**

**Working section and/or intermediate section**

**V35**

Valvola limitatrice di pressione (o antiurto), registrabile, con anticavitazione, su effetto A e B (per le tarature vedere par. 11).  
*Pressure limiting valve (or antishock), adjustable, with anticavitation, on A and B port (for the setting see par. 11).*

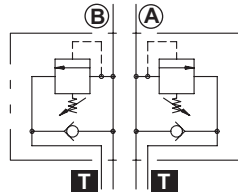

**V04**

Valvola anticavitazione su effetto A.  
*Anticavitation valve on A port.*

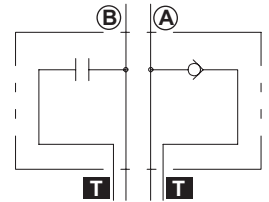

**V40**

Valvola limitatrice di pressione (o antiurto), registrabile su effetto A e anticavitazione su effetto B (per le tarature vedere par. 11).  
*Pressure limiting valve (or antishock), adjustable on A port and anticavitation on B port (for the setting see par. 11).*

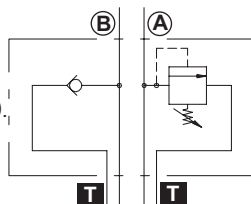

**V05**

Valvola anticavitazione su effetto B.  
*Anticavitation valve on B port.*

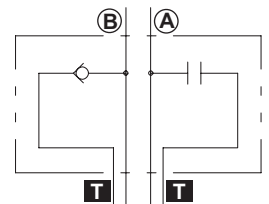

**V41**

Valvola anticavitazione su effetto A e valvola limitatrice di pressione (o antiurto), registrabile su effetto B (per le tarature vedere par. 11).  
*Anticavitation valve on A port and pressure limiting valve (or antishock), adjustable on B port (for the setting see par. 11).*

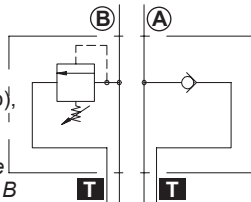

**V06**

Valvola anticavitazione doppia su effetti A e B.  
*Anticavitation valve, double-acting on A and B ports.*

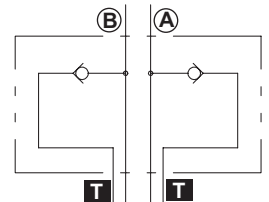

**11 - Tipo molla e taratura valvola**

Dove è presente la valvola VLP (V30 - V31 - V32 - V33 - V34 - V35 - V40 - V41), deve essere specificato il tipo di molla (**B**, **N**, o **R**) e la sua pressione di taratura; **se quest'ultima viene omessa, verrà messa la molla N tarata a 150 bar.**

**11 - Type of spring and valve setting**

If valve VLP is installed (V30 - V31 - V32 - V33 - V34 - V35 - V40 - V41), specify the type of spring (**B**, **N**, or **R**) and its pressure setting. If omitted, **spring N with a 150 bar setting will be installed.**

		molla bianca white spring	molla nera black spring	molla rossa red spring	
		<b>B</b>	<b>N</b>	<b>R</b>	
<b>R</b>	Tipo di molla per la VLP Type of spring for relief valve				
Campi di taratura / Calibration fields bar (psi)					
<b>250</b>	Taratura della VLP VLP Setting	<b>Q30 - GSV50</b>	50 ÷ 80 (435 ÷ 1160)	81 ÷ 200 (1175 ÷ 2900)	201 ÷ 350 (4365 ÷ 5800)
		<b>Q80</b>	30 ÷ 80 (435 ÷ 1160)	81 ÷ 200 (1175 ÷ 2900)	201 ÷ 370 (2915 ÷ 5365)
		<b>Q130</b>	30 ÷ 80 (435 ÷ 1160)	81 ÷ 200 (1175 ÷ 2900)	201 ÷ 350 (2915 ÷ 5075)
Il range completo delle valvole Q80 e Q130 si ottiene con l'aggiunta di spessori. Le valvole del Q30 GSV50 (Q50) non si possono smontare quindi non è possibile aggiungere spessori. <i>The complete range for the Q80 and Q130 valves can be obtained with additional thickness. Q30 GSV50 (Q50) can not be unmount than is not possible add thickness.</i>					



Sezione di lavoro e/o elemento intermedio

Working section and/or intermediate section

Q30	F7S	R250	MSE	E50	R250	2x	103	A1	M1	V30	R250	V01	F3D	12V	2E+1
1	2	3	4	5	6		7	8	9	10	11	12	13	16	17

12 - Tipo valvole a pannello / Panel valves type

		Q30	GSV50	Q80	Q130
<b>V01</b>	Valvola di ritegno pilotata singola su effetto A (*) <i>Single piloted check valve on A port (*)</i>	•	•	•	•
<b>V02</b>	Valvola di ritegno pilotata singola su effetto B (*) <i>Single piloted check valve on B port (*)</i>	•	•	•	•
<b>V03</b>	Valvola di ritegno pilotata singola su effetti A e B (*) <i>Single piloted check valve on A and B ports (*)</i>	•	•	•	•
<b>VP</b>	Corpo distributore predisposto per valvola a pannello <i>Control valve body preset for panel-mounted valve</i>	•	•	•	•
<b>VPC</b>	Corpo distributore predisposto per valvola antiurto o anticavitazione e per valvola a pannello <i>Control valve body preset for antishock valve or anticavitation and for panel-mounted valve</i>	•	•	•	•
<b>VPFE</b>	Corpo distributore predisposto per valvola di flottante elettrico a pannello <i>Control valve body preset for electric floating valve, panel mounted</i>	•	•		
<b>VFE</b>	Valvola per flottante elettrico. Da utilizzare su cursori con utilizzi A e/o B chiusi in pos. 0 per creare elettricamente la posizione di flottante. Specificare al tensione: <b>12 V.DC. - 24 V.DC.</b> <i>Valve for electric floating. To use on spool with A and/or B ports closed in 0 position and for generating electrically the floating position. Specify the voltage: 12 V.DC. - 24 V.DC.</i>	•	•		

**V01**

Valvola di ritegno pilotata singola su effetto A (\*).  
*Single piloted check valve on A port (\*)*

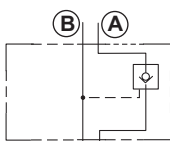

**V02**

Valvola di ritegno pilotata singola su effetto B (\*).  
*Single piloted check valve on B port (\*)*

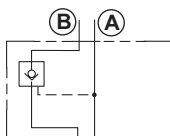

**V03**

Valvola di ritegno pilotata singola su effetti A e B (\*).  
*Single piloted check valve on A and B ports (\*)*

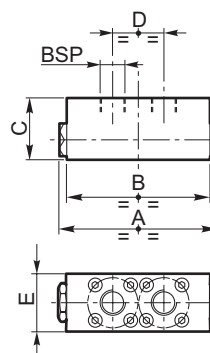
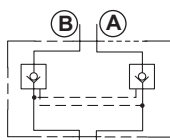

	A	B	C	D	E	BSP
<b>Q30</b>	105 (4.134)	95 (3.740)	41 (1.614)	34 (1.339)	37.5 (1.476)	3/8"
<b>Q80</b>	130 (5.118)	122 (4.803)	50 (1.969)	43 (1.693)	45 (1.772)	1/2"
<b>Q130</b>	173 (6.811)	165 (6.496)	65 (2.559)	76 (2.992)	47 (1.850)	3/4"

	* Rapporto di pilotaggio <i>Piloting ratio</i>	Coppia di serraggio delle viti di fissaggio <i>Fastening screw tightening</i>
<b>Q30</b>	1 : 2.42	8 Nm 2 Nm - solo per viti VFE / only for VFE screws
<b>Q80</b>	1 : 3.25	10 Nm
<b>Q130</b>	1 : 2.80	10 Nm

## Sezione di lavoro e/o elemento intermedio

## Working section and/or intermediate section

## VP

Corpo distributore predisposto per valvola a pannello.  
Control valve body preset for panel-mounted valve.

## VPC

Corpo distributore predisposto per valvola antiurto o anticavitazione e per valvola a pannello.  
Control valve body preset for antishock valve or anticavitation and for panel-mounted valve.

## VPFE

Corpo distributore predisposto per valvola di flottante elettrico a pannello.  
Control valve body preset for electric floating valve, panel mounted.

## VFE

Valvola per flottante elettrico.  
Da utilizzare su cursori con utilizzi A e/o B chiusi in pos. 0 per creare elettricamente la posizione di flottante.  
Specificare al tensione: **12 V.DC. - 24 V.DC.**  
Valve for electric floating.  
To use on spool with A and/or B ports closed in 0 position and for generating electrically the floating position.  
Specify the voltage: **12 V.DC. - 24 V.DC.**

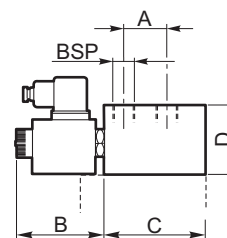
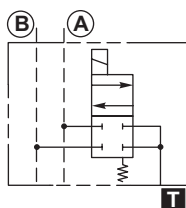

	A	B	C	D	BSP
Q30	34 (1.339)	69 (2.717)	80 (3.150)	80 (3.150)	3/8"



Fiancata di scarico

Outlet section

Q30	F7S	R250	MSE	E50	R250	2x	103	A1	M1	V30	R250	V01	F3D	12V	2E+1
1	2	3	4	5	6		7	8	9	10	11	12	13	16	17

13 - Tipo fiancata di scarico / Outlet section type

		Q30	GSV50	Q80	Q130
<b>F3D</b>	Fiancata di scarico	Outlet section	•	•	•
<b>F6D</b>	Fiancata di scarico con alimentazione in pressione per altri componenti (carry-over)	Outlet section and high pressure (carry-over)	•	•	•
<b>F16D</b>	Fiancata di scarico destro per centro chiuso	Right outlet section for through passage closed	•	•	•
<b>F9D</b>	Fiancata di scarico destro per comando elettroidraulico proporzionale con valvola di contropressione	Right outlet section for electrohydraulic proportional control with back pressure valve			•
<b>F11D</b>	Fiancata di scarico destro per comando elettroidraulico proporzionale	Right outlet section for electrohydraulic proportional control			•

**F3D**

Fiancata di scarico  
Outlet section

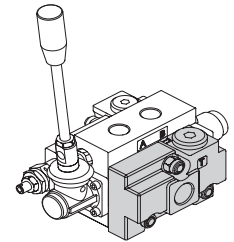
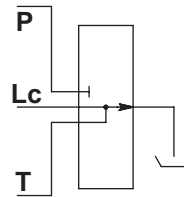
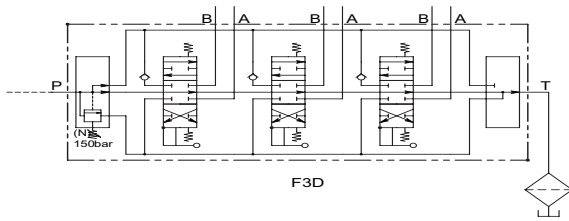

**F6D**

Fiancata di scarico con alimentazione in pressione per altri componenti (carry-over)  
Outlet section and high pressure (carry-over)

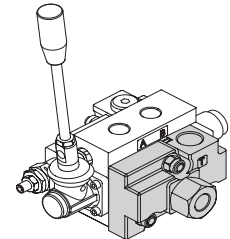
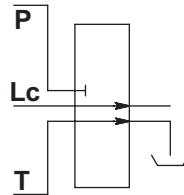
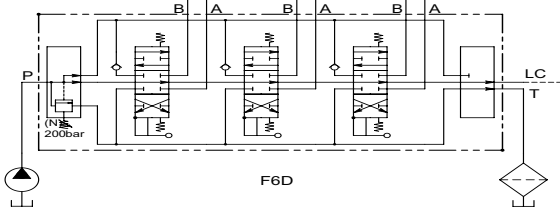

**Fiancata di scarico**

**Outlet section**



**F16D**

Fiancata di scarico destro per centro chiuso  
 Right outlet section for through passage closed

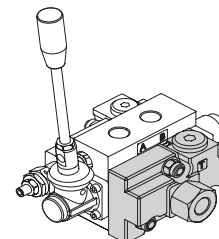
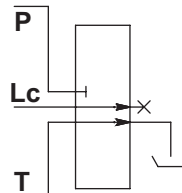

**F9D**

Fiancata di scarico destro per comando elettroidraulico proporzionale con valvola di contropressione  
 Right outlet section for electrohydraulic proportional control with back pressure valve

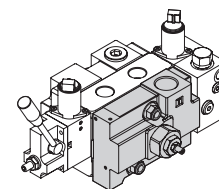
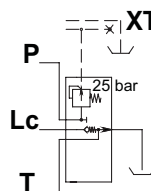

**F11D**

Fiancata di scarico destro per comando elettroidraulico proporzionale con carry-over  
 Right outlet section for electrohydraulic proportional control with power beyond

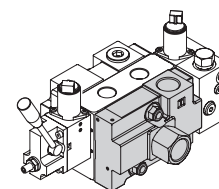
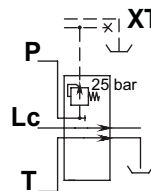

## Fiancata di ingresso supplementare

## Additional inlet section

## 13 - Ingresso supplementare

## 13 - Additional inlet section

I seguenti ingressi supplementari, dotati di due ingressi laterali e uno scarico centrale, possono essere utilizzati in sostituzione della fiancata di scarico utilizzando come scarico l'elemento intermedio **E51** (vedi par. 5, pag. G-18).

La designazione verrà modificata come segue:

The following additional inlet sections, fitted with two lateral inlets and with a central outlet can be used as a replacement of the outlet section by using the intermediate element **E51** (see par. 5, page G-18) as relief.

The designation will be modified as follows:



		Q30	GSV50	Q80	Q130
<b>F7D</b>	Collettore di entrata destro con valvola limitatrice di pressione VLP	•	•	•	•
<b>F17D</b>	Collettore di entrata destro con valvola limitatrice di pressione VLP e attacco T3		•		•
<b>F7DP</b>	Collettore di entrata destro con valvola limitatrice di pressione pilotata				•
<b>F17DP</b>	Collettore di entrata destro con valvola limitatrice di pressione pilotata e attacco T3				•
<b>F8D</b>	Collettore di entrata destro senza valvole	•	•	•	•
<b>F18D</b>	Collettore di entrata destro senza valvole e attacco T3		•		•

**F7D****F17D**

Collettore di entrata con valvola limitatrice di pressione VLP  
Inlet section with relief valve VLP

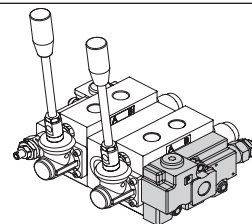

## 14 - Tipo molla e taratura valvola

Dove è presente la valvola VLP (fiancate F7D), deve essere specificato il tipo di molla (**B**, **N** o **R**) e la sua pressione di taratura; se quest'ultima viene omessa la valvola verrà tarata a **150** bar. Dove è presente la VLPP indicare solo la pressione di taratura.

## 14 - Outlet section type

If valve VLP is installed (inlet section F7D), specify the type of spring (**B**, **N** or **R**) and its pressure setting. If this latter is omitted, spring N with a 150 bar setting will be installed. For VLPP valve specify only pressure setting.

		molla bianca white spring	molla nera black spring	molla rossa red spring
<b>R</b>	Tipo di molla per la VLP Type of spring for relief valve	<b>B</b>	<b>N</b>	<b>R</b>
Campi di taratura / Calibration fields bar (psi)				
<b>250</b>	Taratura della VLP VLP Setting	10 ÷ 80 (145 ÷ 1160)	81 ÷ 200 (1175 ÷ 2900)	201 ÷ 380 (2915 ÷ 5510)

**F7DP****F17DP**

Collettore di entrata con valvola limitatrice di pressione pilotata VLPP  
Inlet sections with piloted relief valve VLPP

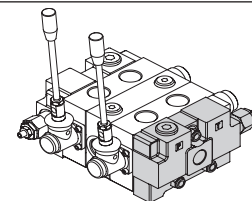
**F8D****F18D**

Collettore di entrata destro senza valvole  
Right inlet section without valves

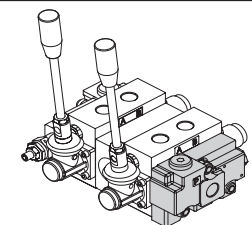

**Fiancata di scarico e/o ingresso supplementare**

**Outlet section or additional inlet section**



**15 - Valvole aggiuntive alla fiancata / Additional valves on the inlet section**

			Q30	GSV50	Q80	Q130
<b>PMS</b>	Collettore di entrata con predisposizione per valvola di messa a scarico elettrica (indiretta) o idraulica <i>Inlet section presets for electrical outlet release valve (indirect) or hydraulic</i>		•	•	•	•
<b>MSI</b>	Collettore di entrata con valvola di messa a scarico idraulica <i>Inlet section with hydraulic outlet release valve</i>		•	•	•	•
<b>MSE</b>	Collettore di entrata con valvola di messa a scarico elettrica (indiretta) <i>Inlet section with electrical outlet release valve (indirect)</i>		•	•	•	•

**PMS**

Collettore di entrata con predisposizione per valvola di messa a scarico elettrica (indiretta) o idraulica  
*Inlet section presets for electrical outlet release valve (indirect) or hydraulic*

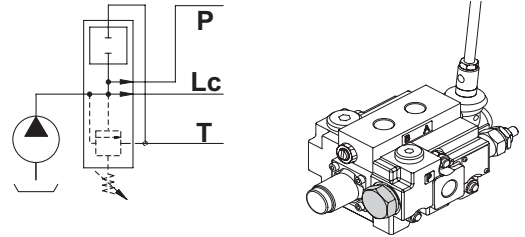

**MSI**

Collettore di entrata con valvola di messa a scarico idraulica  
*Inlet section with hydraulic outlet release valve*

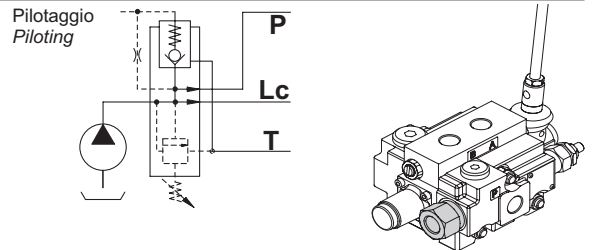

**MSE**

Collettore di entrata con valvola di messa a scarico elettrica (indiretta)  
*Inlet section with electrical outlet release valve (indirect)*

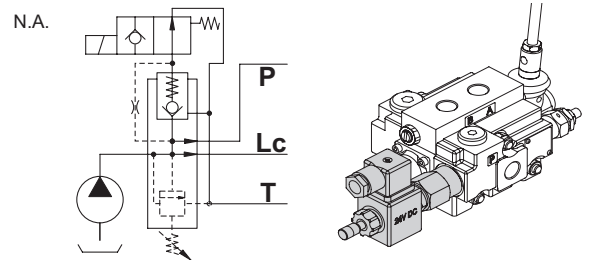

**N.B.**  
Specificare tensione e schema dell'elettrovalvola  
*Specify voltage and scheme of the solenoid operated valve*

Tensione Voltage	Schema Scheme		
12 V.DC	<b>N.C.</b>	Normalmente chiusa <i>Usually closed</i>	
24 V.DC	<b>N.A.</b>	Normalmente aperta <i>Usually open</i>	

## Note aggiuntive

## Additional notes

Q30	F7S	R250	MSE	E50	R250	2x	103	A1	M1	V30	R250	V01	F3D	12V	2E+1
1	2	3	4	5	6		7	8	9	10	11	12	13	16	17

## 16 - Note aggiuntive / Additional notes

## 16 - Additional notes

12V, 24V

S Alluminio (pag. G-6 ... G-10)

12V, 24V

S Aluminium (page G-6 ... G-10)

Codice asta di comando (vedi tabella seguente)

Control lever code (see next table)

Codice / Code	Versione / Version	M	L	D	A	B	Colore / Color
---------------	--------------------	---	---	---	---	---	----------------

Q30 - GSV50 - (Q50)		Dimensioni in / Dimensions in: mm (inch)						
06.029.22862	1	Standard / Standard	M8	164 (6.457)	20 (0.787)	57 (2.244)	20 (0.787)	Nero / Black
06.029.30335	1	Standard / Standard	M8	164 (6.457)	20 (0.787)	57 (2.244)	20 (0.787)	Rosso / Red
06.029.30528	1	Lunga tipo A / Long version type A	M8	184 (7.244)	20 (0.787)	57 (2.244)	20 (0.787)	Nero / Black
06.029.30492	1	Lunga tipo A / Long version type A	M8	184 (7.244)	20 (0.787)	57 (2.244)	20 (0.787)	Rosso / Red
06.029.28922	1	Lunga / Long version	M8	204 (8.031)	20 (0.787)	57 (2.244)	20 (0.787)	Nero / Black
06.029.30336	1	Lunga / Long version	M8	204 (8.031)	20 (0.787)	57 (2.244)	20 (0.787)	Rosso / Red
06.029.27421	1	Extra lunga / Extra-long	M8	324 (12.756)	20 (0.787)	57 (2.244)	20 (0.787)	Nero / Black
06.029.22876	1	Extra corta / Extra-short	M8	82 (3.228)	18 (0.709)	50 (1.969)	20 (0.787)	Nero / Black
06.029.29451	2	Standard con oblo' / Standard with lens	M8	174 (6.850)	32 (1.260)	46 (1.811)	20 (0.787)	Nero / Black
06.029.29423	2	Lunga con oblo' / Long with lens	M8	214 (8.425)	32 (1.260)	46 (1.811)	20 (0.787)	Nero / Black

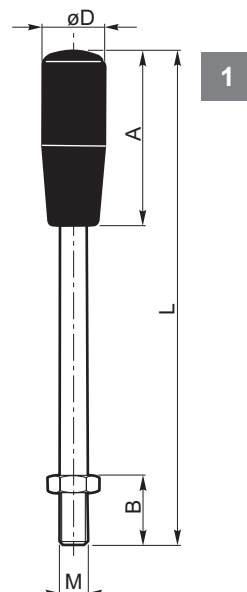

Q80 - Q130		Dimensioni in / Dimensions in: mm (inch)						
06.029.27013	1	Standard / Standard	M10	209 (8.228)	20 (0.787)	57 (2.244)	28 (1.102)	Nero / Black
06.029.28148	1	Lunga / Long version	M10	357 (14.055)	20 (0.787)	57 (2.244)	28 (1.102)	Nero / Black
06.029.27344	1	Corta / Short version	M10	154 (6.063)	20 (0.787)	57 (2.244)	28 (1.102)	Nero / Black
06.029.27635	1	Extra corta / Extra-short	M10	66 (2.598)	26 (1.024)	42 (1.654)	22 (0.866)	Nero / Black
06.029.29866	2	Standard con oblo' / Standard with lens	M10	219 (8.622)	32 (1.260)	46 (1.811)	28 (1.102)	Nero / Black
06.029.30295	2	Lunga con oblo' / Long with lens	M10	367 (14.449)	32 (1.260)	46 (1.811)	28 (1.102)	Nero / Black

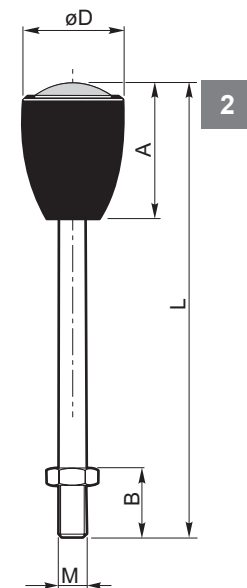

Per comando elettrico / For electric control		Dimensioni in / Dimensions in: mm (inch)						
Q30 - GSV50 - (Q50)		Dimensioni in / Dimensions in: mm (inch)						
06.029.28945	1	Standard / Standard	Ø7	133 (5.236)	20 (0.787)	57 (2.244)	15 (0.591)	Nero / Black
06.029.29349	1	Lunga / Long version	Ø7	201 (7.913)	20 (0.787)	57 (2.244)	15 (0.591)	Nero / Black
06.029.30951	2	Standard con oblo' / Standard with lens	Ø7	143 (5.630)	32 (1.260)	46 (1.811)	15 (0.591)	Nero / Black

Dimensioni in / Dimensions in: mm (inch)

## Note aggiuntive

## Additional notes

Q30	F7S	R250	MSE	E50	R250	2x	103	A1	M1	V30	R250	V01	F3D	12V	2E+1
1	2	3	4	5	6		7	8	9	10	11	12	13	16	17

## 17 - Numero sezioni di lavoro

Specificare il numero delle sezioni di lavoro (es. 2E) e il numero degli elementi intermedi (es. +1) utilizzati tenendo sempre in considerazione che la somma dei due non potrà superare il limite massimo di 10.

## 17 - Number of working sections

Specify the number of working sections (for ex. 2E) and the number of intermediate elements (for ex. +1) used, always taking into account that the sum of the two will not have to exceed the maximum limit of 10.

ESEMPI DI ORDINAZIONE IN CODICE  
ORDERING CODE EXAMPLES

Q30 - F7SN - 403/A1/M1 - 2x103/A1/M1 - F3D - S - SAE - 3E

F	G				H								I	L	
1	2	3	4	5 - 6 - 7 - 8 - 9 - 10 - 11 - 12								13	16 - 17		
Q30	F7S	N200		403/A1/M1 2x 103/A1/M1								F3D	S - SAE - 3E		

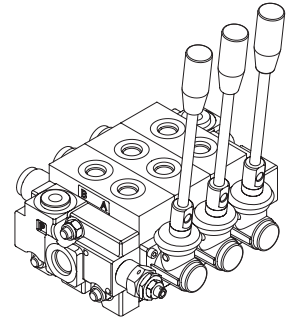

Schema idraulico  
Hydraulic symbol

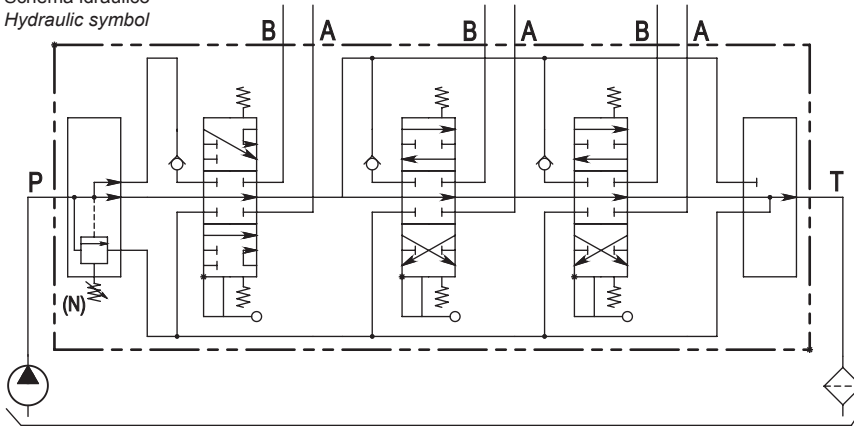

Q30 - F7S R(300) - 103/A1/M1 - 126/A353/R10-Z1/V30 G(250) - 103/M1/V35 N(180) - 103/A1/DP/V33 N(180) - 103/A1/DP/V31 G(250) - 103/A1/M1 - F3D - 12V - 6E

F	G				H								I	L	
1	2	3	4	5 - 6 - 7 - 8 - 9 - 10 - 11 - 12								13	16 - 17		
Q30	F7S	R300		103/A1/M1 126/A353/R10-Z1/V30 G(250) 103/M1/V35 N(180) 103/A1/DP/V33 N(180) 103/A1/DP/V31 G(250) 103/A1/M1								F3D	12V - 6E		

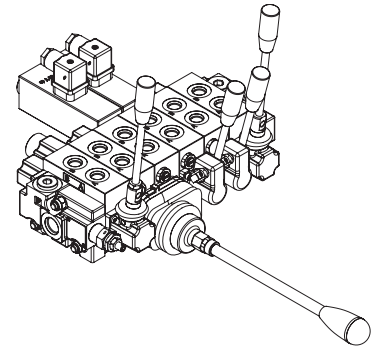

Schema idraulico  
Hydraulic symbol

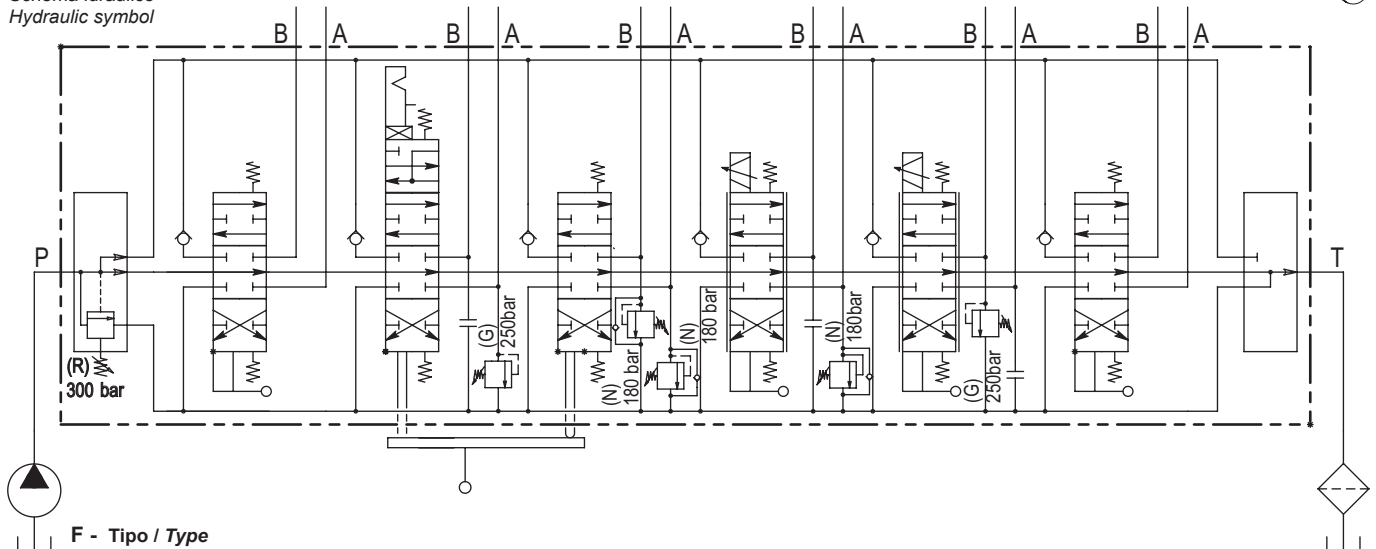

F - Tipo / Type

G - Fiancata d'ingresso / Inlet section

H - Sezione di lavoro e/o elemento intermedio / Working section and/or intermediate section

I - Fiancata di scarico o ingresso supplementare / Outlet section or additional inlet section

L - Note aggiuntive / Additional notes

ESEMPI DI ORDINAZIONE IN CODICE  
ORDERING CODE EXAMPLES

Q30 - F7S N(250) - 103/A1/P1-N/V30 N(180) - 2x103/A1/P1-N - 2x103/A1/DP - F3D - 5E

F	G				H								I	L	
1	2	3	4	5 - 6 - 7 - 8 - 9 - 10 - 11 - 12								13	16 - 17		
Q30	F7S	N250		103/A1/P1-N/V30 N(180)								F3D	5E		
				2x 103/A1/P1-N											
				2x 103/A1/DP											

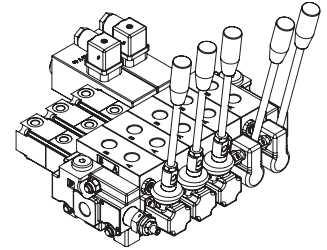

Schema idraulico  
Hydraulic symbol

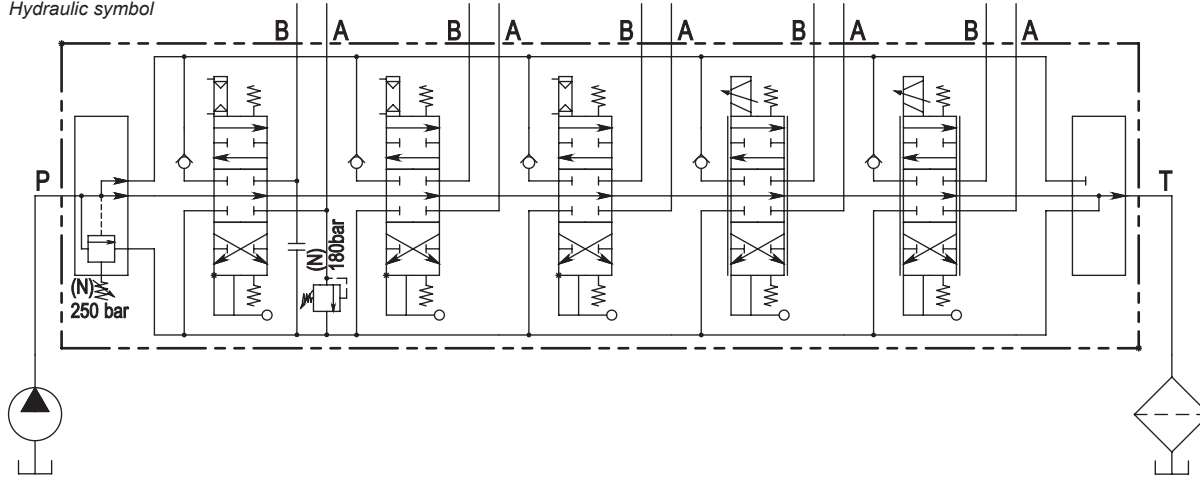

Q130 F7S R(300) MSE (NA) - E62 - 103/A1/D2-1R - 103/A1/D2-2R - 2x103/H1 - F3D - 12V - 4E+1

F	G			H								I	L	
1	2	3	4	5 - 6 - 7 - 8 - 9 - 10 - 11 - 12								13	16 - 17	
Q130	F7S	R300	MSE(NA)	E62								F3D	12V - 4E+1	
				103/A1/D2-1R										
				103/A1/D2-2R										
				2x 103/H1										

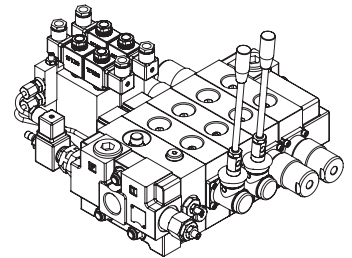

Schema idraulico  
Hydraulic symbol

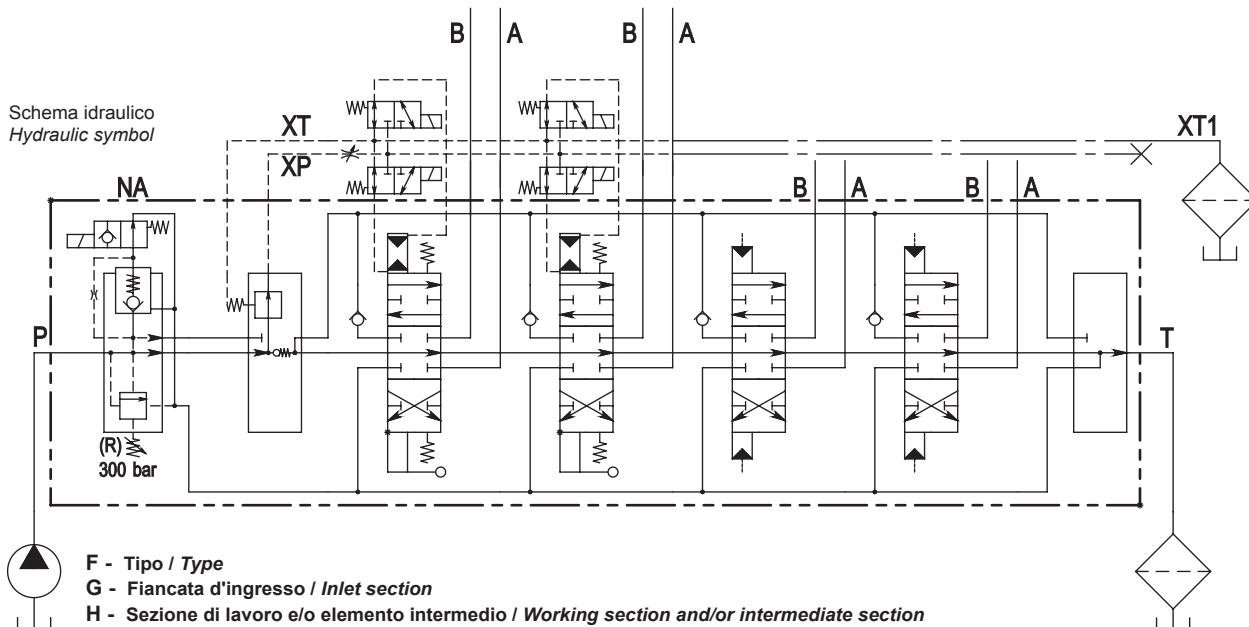

- F - Tipo / Type
- G - Fiancata d'ingresso / Inlet section
- H - Sezione di lavoro e/o elemento intermedio / Working section and/or intermediate section
- I - Fiancata di scarico o ingresso supplementare / Outlet section or additional inlet section
- L - Note aggiuntive / Additional notes

## ESEMPI DI ORDINAZIONE IN CODICE ORDERING CODE EXAMPLES

Q30 - F7S(N) - 2x116/A1-Z1/R8 - E68 - 111/A1/M1/V03 - F3D - 4E

F	G				H								I	L	
1	2	3	4	5 - 6 - 7 - 8 - 9 - 10 - 11 - 12								13	16 - 17		
Q30	F7S	N200		2x 116/A1-Z1/R8								F3D	4E		
				E68											
				111/A1/M1/V03											

Schema idraulico  
Hydraulic symbol

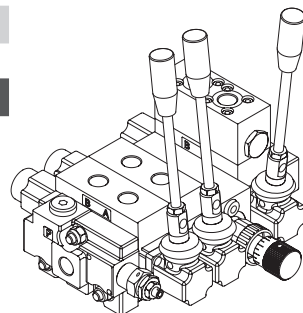
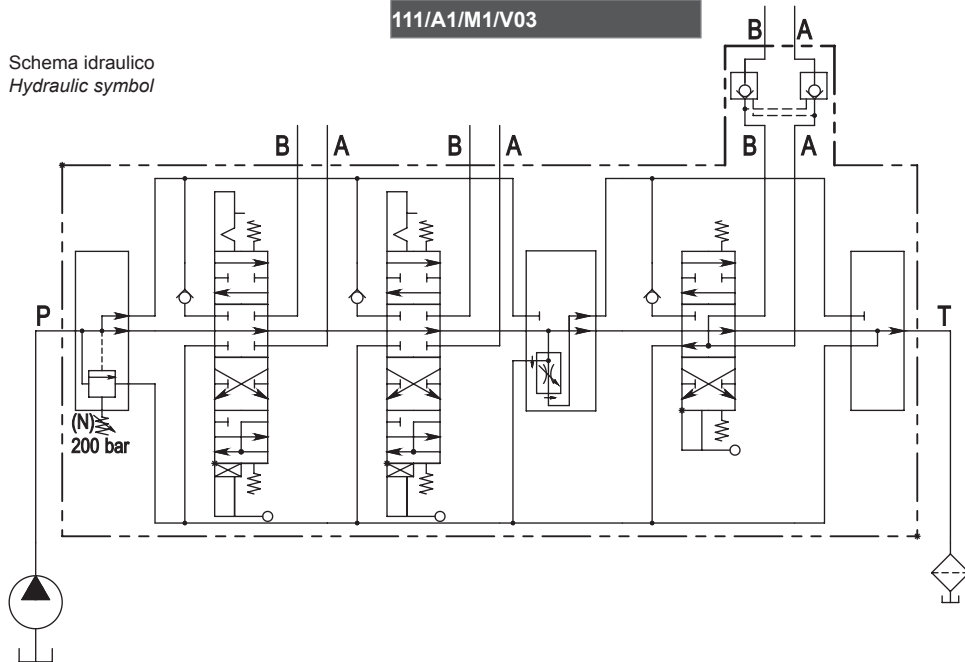

GSV50 - F8S - 203/A6H/R3K - 103/A6H/R3K - F6D - 2E

F	G				H								I	L	
1	2	3	4	5 - 6 - 7 - 8 - 9 - 10 - 11 - 12								13	16 - 17		
GSV50	F8S			203/A6H/R3K								F6D	2E		
				103/A6H/R3K											

Schema idraulico  
Hydraulic symbol

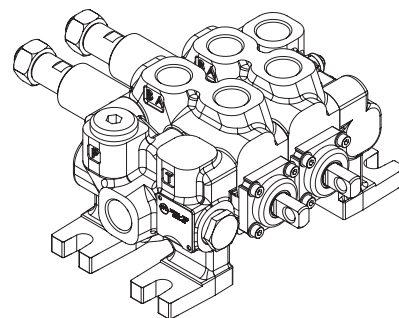
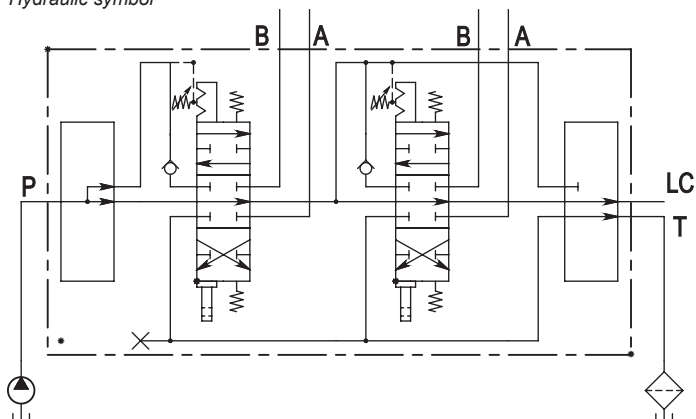

F - Tipo / Type

G - Fiancata d'ingresso / Inlet section

H - Sezione di lavoro e/o elemento intermedio / Working section and/or intermediate section

I - Fiancata di scarico o ingresso supplementare / Outlet section or additional inlet section

L - Note aggiuntive / Additional notes





## DISTRIBUTORI A COMANDO ELETTRICO DIRETTO CON FIANCATA PROPORZIONALE *DIRECTIONAL CONTROL VALVE WITH DIRECT ELECTRICAL CONTROL AND PROPORTIONAL SECTION*

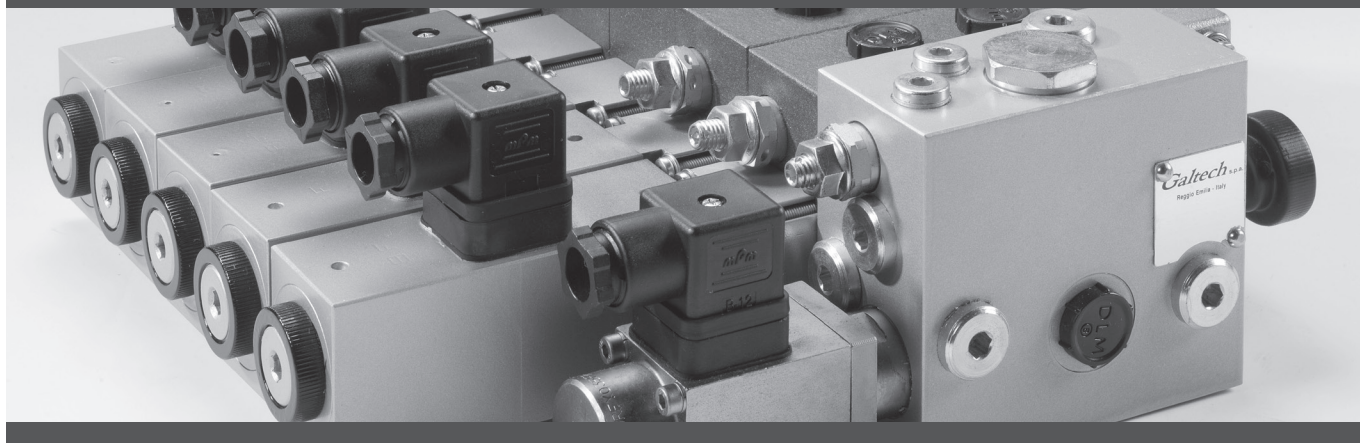

Pag.  
Page

<b>CARATTERISTICHE FEATURES</b>	C-2
<b>CARATTERISTICHE TECNICHE TECHNICAL CHARACTERISTICS</b>	C-3
<b>ESEMPIO DI ORDINAZIONE IN CODICE EXAMPLE OF ORDERING CODE</b>	C-4
<b>Q30</b>	C-12
<b>GSV50</b>	C-14

## DISTRIBUTORI A COMANDO ELETTRICO DIRETTO CON FIANCATA PROPORZIONALE F7SPR

- Sono un'ulteriore estensione dei distributori a comando elettrico ON-OFF, con applicazione su Q30 e GSV50.
- Operano con una sezione per volta con proporzionalità ottenuta elettronicamente.
- Ogni sezione mantiene, inoltre, il comando manuale.
- I distributori proporzionali sono composti da: una fiancata di entrata, da elementi in quantità variabile da 1 a 10 a comando elettrico ON-OFF e da una fiancata di scarico.
- Nella fiancata di entrata, sono alloggiati: la valvola proporzionale, la quale permette di modulare la portata agli elementi ON-OFF; il compensatore a tre vie, la valvola di massima pressione e la valvola di sicurezza (manuale o elettrica) che permette di operare anche in mancanza di tensione.
- Sono particolarmente adatti nelle applicazioni in cui si effettuano manovre non contemporanee e in cui è fondamentale la sicurezza e la sensibilità dei movimenti, come, ad es. piattaforme sollevabili con operatori a bordo.

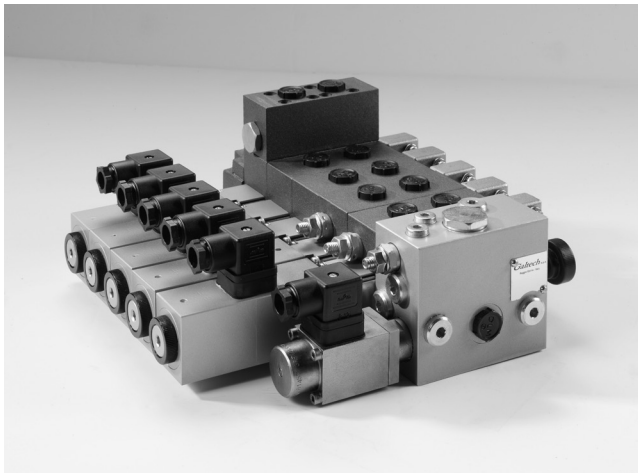

### AVVERTENZA PER L'INSTALLAZIONE DEI DISTRIBUTORI

- I quattro piedini dei distributori devono sempre appoggiare su una superficie perfettamente piana
- Non manomettere i dadi dei tiranti in quanto comprometterebbero il normale funzionamento del distributore.
- Non utilizzare raccordi conici su filetti cilindrici.
- Per pulire il distributore, prima della verniciatura, non utilizzare diluenti/solventi o qualsiasi prodotto che possa intaccare le parti in gomma.

## DIRECTIONAL CONTROL VALVE WITH DIRECT ELECTRICAL CONTROL AND PROPORTIONAL SECTION F7SPR

- *Proportional control valves are a further step in the field of control valves with ON-OFF electrical control, with application on Q30 and QSV50 control valves.*
- *These control valves operate with only one section at a time and its proportionality is obtained by an electronic drive.*
- *Each section keeps hand control.*
- *Proportional control valves consist of: inlet section, working sections (consisting of a variable number of 1-10 electrical ON-OFF elements) and outlet section.*
- *The inlet section is carrying a proportional valve tuning flow to the ON-OFF elements a three-way compensator, a maximum relief valve, a safety valve (either manual or electrical) allows operation also during blackout.*
- *Proportional control valves are particularly suited for applications with not contemporary operations, where security and sensitivity of movements becomes of basic importance, such as on lifting platforms with operator on board.*

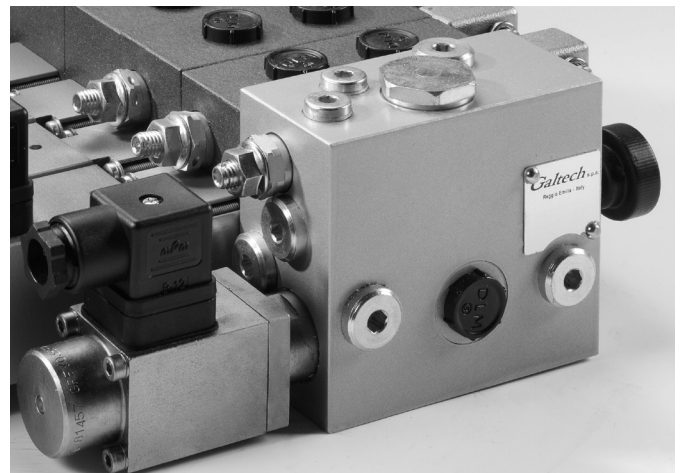

### NOTES FOR DIRECTIONAL CONTROL VALVES ASSEMBLY

- *The valve must always and perfectly rest on a 180° flat surface.*
- *Do not tamper the tie rod nuts so they might impair the standard working of the valve.*
- *No conical nipples with JIC thread must be used.*
- *Before painting the control valve, do not use diluent or any products that could damage rubber parts.*

### Caratteristiche tecniche elettrovalvola proporzionale Characteristics proportional solenoid valve

	Q30	GVS50
Attacco magnete <i>Magnet connection</i>	Tipo DIN 43650 (versione A) <i>Type DIN 43650 (version A)</i>	
Tipo di protezione <i>Protection type</i>	IP 65	
Classe d'isolamento <i>Coil insulation class</i>	F	
Tensione di alimentazione <i>Supply voltage</i>	12 V D.C. 24 V D.C.	
Variazione di tensione max. <i>Maximum voltage tolerance</i>	± 10%	
Isteresi <i>Hysteresis</i>	± 5%	
Tempo di risposta valvola proporzionale <i>Response time proportional valve</i>	10% + 90% = 40ms	
Tempo di risposta valvola proporzionale <i>Response time proportional valve</i>	90% + 10% = 50ms	
Corrente valvola proporz. alimentazione 12V D.C. <i>Current proportional valve 12V D.C. supply</i>	0 ÷ 1 A	
Corrente valvola proporz. alimentazione 24V D.C. <i>Current proportional valve 24V D.C. supply</i>	0 ÷ 1.4A	

### Caratteristiche tecniche distributore Directional control valve characteristics

	Q30	GVS50
Portata max. (lt/min) <i>Max. flow</i>	15 - 30 - 40 lt/min	
Pressione max. di lavoro <i>Max. working pressure</i>	250 bar	
Contropressione max. sullo scarico <i>Max. back outlet pressure</i>	25 bar	
Limiti temperatura olio <i>Oil range temperature</i>	-30 °C ÷ 80 °C	
Temperatura olio consigliata <i>Recommended oil temperature</i>	30 °C ÷ 60 °C	
Filtraggio consigliato <i>Recommended filtering</i>	19/16 ISO DIS 4406	
Fluido consigliato <i>Recommended fluid</i>	olio minerale <i>mineral oil</i>	
Viscosità <i>Viscosity</i>	10 ÷ 400 mm <sup>2</sup> /s	
Manovra di emergenza o manovra in assenza di corrente <i>Emergency operation or in case of power break</i>	Con leva e valvola di sicurezza manuale o elettrica <i>By hand lever and manual or electrical safety valve</i>	
Trafilamento max. di A e B tu T a 100 bar con viscosità 35 mm <sup>2</sup> /s <i>Max. spool leakage of A and B ports to T port at 100 bar with viscosity 35 mm<sup>2</sup>/s</i>	5 cm <sup>3</sup> /min	

## ESEMPIO DI ORDINAZIONE IN CODICE ORDERING CODE EXAMPLE

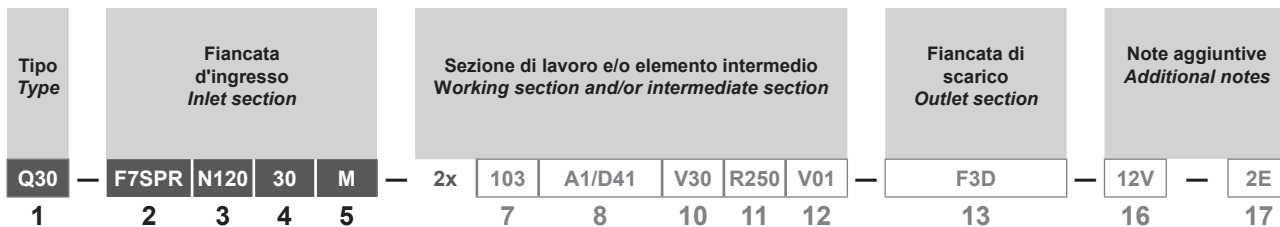

### 1 - Tipo

#### Q30, GSV50.

Indica il tipo di distributore; le caratteristiche dimensionali sono riportate da pag. C12 a pag. C16

### 1 - Type

#### Q30, GSV50.

Indicates the type of directional control valve. The dimensional specifications are given from page C12 to page C16.

## Fiancata di ingresso proporzionale

## Proportional inlet section

### 2 - Tipo fiancata d'ingresso proporzionale

### 2 - Type of proportional inlet section

## F7SPR

Fiancata di ingresso proporzionale  
Proportional inlet section

### 3 - Taratura valvola VLP

Per la valvola VLP, deve essere specificato il tipo di molla (**B**, **N**, **G** o **R**) e la sua pressione di taratura; **se quest'ultima viene omessa, verrà messa la molla N tarata a 120 bar.**

### 3 - VLP Valve setting

For VLP valve specify the type of spring (**B**, **N**, **G** or **R**) and its pressure setting. **If omitted, spring N with a 120 bar setting will be installed.**

		molla bianca white spring				molla nera black spring				molla gialla yellow spring				molla rossa red spring			
N		Tipo di molla per la VLP Type of spring for relief valve		B		N		G		R							
		Campi di taratura / Calibration fields bar (psi)															
120	Taratura della VLP VLP Setting	Q30 - GSV50		30 ÷ 80 (435 ÷ 1160)		81 ÷ 200 (1175 ÷ 2900)		201 ÷ 300 (2915 ÷ 4350)		301 ÷ 400 (4365 ÷ 5800)							
Il range completo si ottiene mediante l'aggiunta di spessori The complete range can be obtained with additional thickness																	

Fiancata di ingresso proporzionale

Proportional inlet section

4 - Portata valvola proporzionale

Portate disponibili: 15, 30 e 40 l/min.  
I 40 l/min (10.56 gal/min) si possono avere solo con tensioni di 12 V D.C.

4 - Proportional control valve flow

Available flow: 15, 30 e 40 l/min.  
40 l/min (10.56 gal/min) are only possible with 12 V D.C. supply.

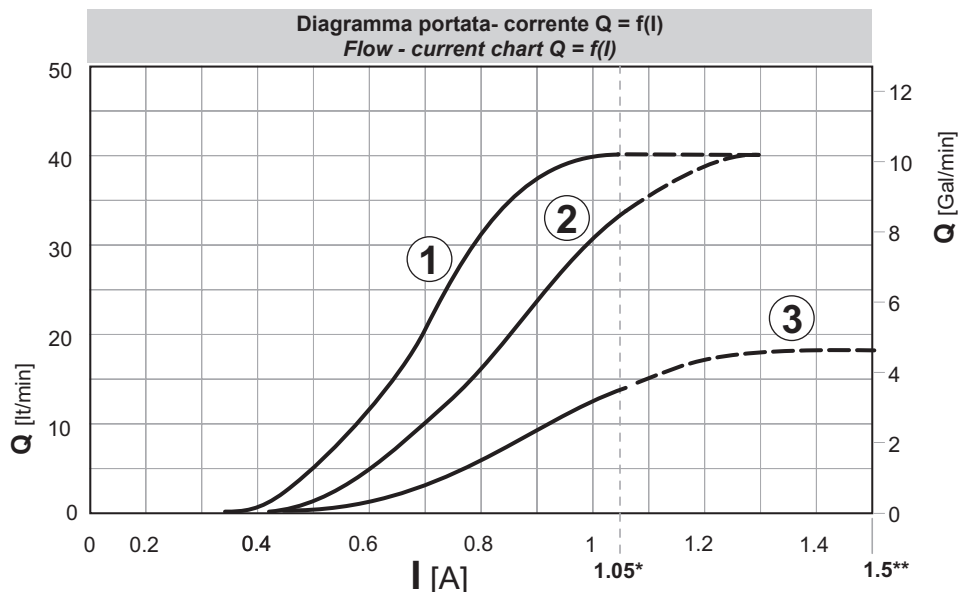

- ① 40 l/min (10.56 gal/min) valve type
- ② 30 l/min (7.92 gal/min) valve type
- ③ 15 l/min (3.96 gal/min) valve type

\* Nel funzionamento a 12 V DC il valore max. di corrente per funzionamento continuo è di 1.05 A.  
\*\* Nel funzionamento a 24 V DC il valore max. di corrente per funzionamento continuo è di 1.5 A.  
Prove eseguite con olio minerale avente viscosità 35 mm<sup>2</sup> /s alla temperatura di 80 °C. Tolleranza sulla portata ± 5 %.

\* The maximum current for continuous operation with 12 V DC is 1.05 A.  
\*\* The maximum current for continuous operation with 24 V DC is 1.5 A.  
All tests were performed with mineral oil, viscosity 35 mm<sup>2</sup> /sec., at a temperature of 80 °C. Flow tolerance ± 5 %.

5 - Dispositivo di emergenza

5 - Safety device

<b>M</b>	<p><b>Emergenza manuale</b> <i>Manual safety device</i></p>		
<b>E-NA</b>	<p><b>Emergenza elettrica</b> <i>Electrical safety device</i></p> <p>Sicurezza elettrica normalmente aperta <i>Electrical safety device - normally opened</i></p>		
<b>E-NC</b>	<p>Sicurezza elettrica normalmente chiusa <i>Electrical safety device - normally closed</i></p>		

**Sezione di lavoro e/o elemento intermedio**

**Working section and/or intermediate section**

Q30	F7SPR	N120	30	M	2x	103	A1/D41	V30	R250	V01	F3D	12V	2E
1	2	3	4	5		7	8	10	11	12	13	16	17

I campi da 7 a 12 sono da ripetere per ogni sezione. Nel caso in cui due sezioni contigue siano identiche, è sufficiente descriverne solo una antepoendo **2x** al campo 7.

Fields 7 to 12 must be repeated for each section. If two adjacent sections are identical, just describe one and put **2x** before field 7.

**7 - Tipo cursore / Spool type**

			Q30	GSV50
101	Semplice effetto in A	Single acting in A port	•	•
102	Semplice effetto in B	Single acting in B port	•	•
103	Doppio effetto, A e B chiusi in posizione 0	Double acting A and B closed in 0 position	•	•
107	Doppio effetto, A in T e B chiuso in posizione 0	Double acting, A to T and B closed in 0 position	•	•
108	Doppio effetto, B in T e A chiuso in posizione 0	Double acting, B to T and A closed in 0 position	•	•
109	Semplice effetto in A, A in T in posizione 0	Single acting in A, A to T in 0 position	•	•
110	Semplice effetto in B, B in T in posizione 0	Single acting in B, B to T in 0 position	•	•
111	Doppio effetto, A e B in T in posizione 0	Double acting, A and B to T in 0 position	•	•

**101**

Semplice effetto in A  
*Single acting in A port*

**108**

Doppio effetto, B in T e A chiuso in posizione 0  
*Double acting, B to T and A closed in 0 position*

**102**

Semplice effetto in B  
*Single acting in B port*

**109**

Semplice effetto in A, A in T in posizione 0  
*Single acting in A, A to T in 0 position*

**103**

Doppio effetto, A e B chiusi in posizione 0  
*Double acting, A and B closed in 0 position*

**110**

Semplice effetto in B, B in T in posizione 0  
*Single acting in B, B to T in 0 position*

**107**

Doppio effetto, A in T e B chiuso in posizione 0  
*Double acting, A to T and B closed in 0 position*

**111**

Doppio effetto, A e B in T in posizione 0  
*Double acting, A and B to T in 0 position*

Q30	F7SPR	N120	30	M	2x	103	A1/D41	V30	R250	V01	F3D	12V	2E+1
1	2	3	4	5		7	8	10	11	12	13	16	17

**8 - Comando completo A1/D41**

Vedere pag. B-44.

**8 - Complete controls A1/D41**

See page B-44.

Sezione di lavoro e/o elemento intermedio

Working section and/or intermediate section

Q30	F7SPR	N120	30	M	2x	103	A1/D41	V30	R250	V01	F3D	12V	2E
1	2	3	4	5		7	8	10	11	12	13	16	17

10 - Tipo valvole a cartuccia / Type of built-in cartridge valves

			Q30	GSV50
VC	Tappo di chiusura per corpo distributore predisposto per valvole antiurto e/o anticavitazione	Closing plug for directional control valve body preset for shock and/or anticavitation valves	•	•
V30	Valvola limitatrice di pressione (o antiurto), registrabile, su effetto A (per le tarature vedere par. 11)	Pressure limiting valve (or antishock), adjustable, on A port (for the setting see par. 11)	•	•
V31	Valvola limitatrice di pressione (o antiurto), registrabile, su effetto B (per le tarature vedere par. 11)	Pressure limiting valve (or antishock), adjustable, on B port (for the setting see par. 11)	•	•
V32	Valvola limitatrice di pressione (o antiurto), registrabile, su effetto A e B (per le tarature vedere par. 11)	Pressure limiting valve (or antishock), adjustable, on A and B port (for the setting see par. 11)	•	•
V33	Valvola limitatrice di pressione (o antiurto), registrabile, con anticavitazione, su effetto A (per le tarature vedere par. 11)	Pressure limiting valve (or antishock), adjustable, with anticavitation, on A port (for the setting see par. 11)	•	•
V34	Valvola limitatrice di pressione (o antiurto), registrabile, con anticavitazione, su effetto B (per le tarature vedere par. 11)	Pressure limiting valve (or antishock), adjustable, with anticavitation, on B port (for the setting see par. 11)	•	•
V35	Valvola limitatrice di pressione (o antiurto), registrabile, con anticavitazione, su effetto A e B (per le tarature vedere par. 11)	Pressure limiting valve (or antishock), adjustable, with anticavitation, on A and B port (for the setting see par. 11)	•	•
V40	Valvola limitatrice di pressione (o antiurto), registrabile su effetto A e anticavitazione su effetto B (per le tarature vedere par. 11)	Pressure limiting valve (or antishock), adjustable on A port and anticavitation on B port (for the setting see par. 11)	•	•
V41	Valvola anticavitazione su effetto A e valvola limitatrice di pressione (o antiurto), registrabile su effetto B (per le tarature vedere par. 11)	Anticavitation valve on A port and pressure limiting valve (or antishock), adjustable on B port (for the setting see the par. 11)	•	•
V04	Valvola anticavitazione su effetto A	Anticavitation valve on A port	•	•
V05	Valvola anticavitazione su effetto B	Anticavitation valve on B port	•	•
V06	Valvola anticavitazione doppia su effetti A e B	Anticavitation valve, double-acting on A and B ports	•	•

**VC**

Tappo di chiusura per corpo distributore predisposto per valvole antiurto e/o anticavitazione.  
*Closing plug for directional control valve body preset for shock and/or anticavitation valves.*

**V32**

Valvola limitatrice di pressione (o antiurto), registrabile, su effetto A e B (per le tarature vedere pagina seguente).  
*Pressure limiting valve (or antishock), adjustable, on A and B port (for the setting see next page).*

**V30**

Valvola limitatrice di pressione (o antiurto), registrabile, su effetto A (per le tarature vedere pagina seguente).  
*Pressure limiting valve (or antishock), adjustable, on A port (for the setting see next page).*

**V33**

Valvola limitatrice di pressione (o antiurto), registrabile, con anticavitazione, su effetto A (per le tarature vedere pagina seguente).  
*Pressure limiting valve (or antishock), adjustable, with anticavitation, on A port (for the setting see next page).*

**V31**

Valvola limitatrice di pressione (o antiurto), registrabile, su effetto B (per le tarature vedere pagina seguente).  
*Pressure limiting valve (or antishock), adjustable, on B port (for the setting see next page).*

**V34**

Valvola limitatrice di pressione (o antiurto), registrabile, con anticavitazione, su effetto B (per le tarature vedere pagina seguente).  
*Pressure limiting valve (or antishock), adjustable, with anticavitation, on B port (for the setting see next page).*



**Sezione di lavoro e/o elemento intermedio**

**Working section and/or intermediate section**

**V35**

Valvola limitatrice di pressione (o antiurto), registrabile, con anticavitazione, su effetto A e B (per le tarature vedere par. 11).  
*Pressure limiting valve (or antishock), adjustable, with anticavitation, on A and B port (for the setting see par. 11).*

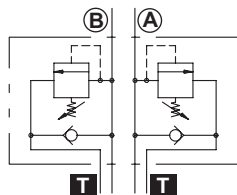

**V04**

Valvola anticavitazione su effetto A.  
*Anticavitation valve on A port.*

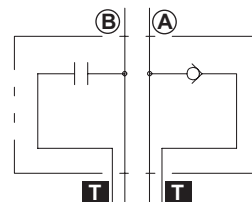

**V40**

Valvola limitatrice di pressione (o antiurto), registrabile su effetto A e anticavitazione su effetto B (per le tarature vedere par. 11).  
*Pressure limiting valve (or antishock), adjustable on A port and anticavitation on B port (for the setting see par. 11).*

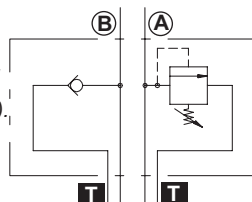

**V05**

Valvola anticavitazione su effetto B.  
*Anticavitation valve on B port.*

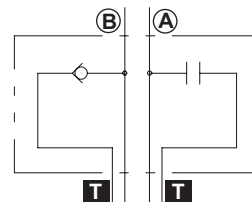

**V41**

Valvola anticavitazione su effetto A e valvola limitatrice di pressione (o antiurto), registrabile su effetto B (per le tarature vedere par. 11).  
*Anticavitation valve on A port and pressure limiting valve (or antishock), adjustable on B port (for the setting see par. 11).*

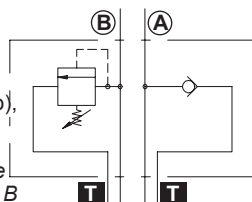

**V06**

Valvola anticavitazione doppia su effetti A e B.  
*Anticavitation valve, double-acting on A and B ports.*

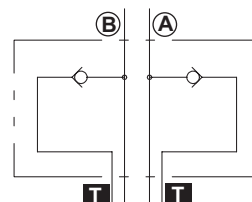

**11 - Tipo molla e taratura valvola**

Dove è presente la valvola VLP (V30 - V31 - V32 - V33 - V34 - V35 - V40 - V41), deve essere specificato il tipo di molla (**B, N, G o R**) e la sua pressione di taratura; **se quest'ultima viene omessa, verrà messa la molla N tarata a 120 bar.**

**11 - Type of spring and valve setting**

If valve VLP is installed (V30 - V31 - V32 - V33 - V34 - V35 - V40 - V41), specify the type of spring (**B, N, G or R**) and its pressure setting. If omitted, **spring N with a 120 bar setting will be installed.**

		molla bianca white spring	molla nera black spring	molla gialla yellow spring	molla rossa red spring	
		<b>B</b>	<b>N</b>	<b>G</b>	<b>R</b>	
<b>R</b>	Tipo di molla per la VLP <i>Type of spring for relief valve</i>					
Campi di taratura / Calibration fields bar (psi)						
<b>250</b>	Taratura della VLP <i>VLP Setting</i>	<b>Q30 - GSV50</b>	30 ÷ 80 (435 ÷ 1160)	81 ÷ 200 (1175 ÷ 2900)	201 ÷ 300 (2915 ÷ 4350)	301 ÷ 400 (4365 ÷ 5800)
Il range completo si ottiene mediante l'aggiunta di spessori <i>The complete range can be obtained with additional thickness</i>						



Sezione di lavoro e/o elemento intermedio

Working section and/or intermediate section

Q30	F7SPR	N120	30	M	2x	103	A1/D41	V30	R250	V01	F3D	12V	2E
1	2	3	4	5		7	8	10	11	12	13	16	17

12 - Tipo valvole a pannello / Panel valves type

		Q30	GSV50
V01	Valvola di ritegno pilotata singola su effetto A (*) <i>Single piloted check valve on A port (*)</i>	•	
V02	Valvola di ritegno pilotata singola su effetto B (*) <i>Single piloted check valve on B port (*)</i>	•	
V03	Valvola di ritegno pilotata singola su effetti A e B (*) <i>Single piloted check valve on A and B ports (*)</i>	•	
VP	Corpo distributore predisposto per valvola a pannello <i>Control valve body preset for panel-mounted valve</i>	•	
VPC	Corpo distributore predisposto per valvola antiurto o anticavitazione e per valvola a pannello <i>Control valve body preset for antishock valve or anticavitation and for panel-mounted valve</i>	•	
VPFE	Corpo distributore predisposto per valvola di flottante elettrico a pannello <i>Control valve body preset for electric floating valve, panel mounted</i>	•	
VFE	Valvola per flottante elettrico. Da utilizzare su cursori con utilizzi A e/o B chiusi in pos. 0 per creare elettricamente la posizione di flottante. Specificare al tensione: <b>12 V.DC. - 24 V.DC.</b> <i>Valve for electric floating. To use on spool with A and/or B ports closed in 0 position and for generating electrically the floating position. Specify the voltage: 12 V.DC. - 24 V.DC.</i>	•	

V01

Valvola di ritegno pilotata singola su effetto A (\*).  
*Single piloted check valve on A port (\*)*

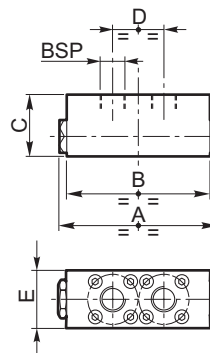
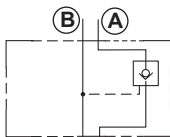

V02

Valvola di ritegno pilotata singola su effetto B (\*).  
*Single piloted check valve on B port (\*)*

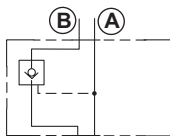

V03

Valvola di ritegno pilotata singola su effetti A e B (\*).  
*Single piloted check valve on A and B ports (\*)*

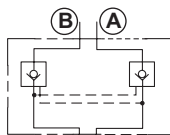

	A	B	C	D	E	BSP
Q30	105 (4.134)	95 (3.740)	41 (1.614)	34 (1.339)	37.5 (1.476)	3/8"

	* Rapporto di pilotaggio <i>Piloting ratio</i>	Coppia di serraggio delle viti di fissaggio <i>Fastening screw tightening</i>
Q30	1 : 2.42	8 Nm 2 Nm - solo per viti VFE / only for VFE screws

**Sezione di lavoro e/o elemento intermedio**

**Working section and/or intermediate section**

**VP**

Corpo distributore predisposto per valvola a pannello.  
*Control valve body preset for panel-mounted valve.*

**VPFE**

Corpo distributore predisposto per valvola di flottante elettrico a pannello.  
*Control valve body preset for electric floating valve, panel mounted.*

**VPC**

Corpo distributore predisposto per valvola antiurto o anticavitazione e per valvola a pannello.  
*Control valve body preset for antishock valve or anticavitation and for panel-mounted valve.*

**VFE**

Valvola per flottante elettrico.  
Da utilizzare su cursori con utilizzi A e/o B chiusi in pos. 0 per creare elettricamente la posizione di flottante.  
Specificare al tensione: **12 V.DC. - 24 V.DC.**  
*Valve for electric floating.*  
To use on spool with A and/or B ports closed in 0 position and for generating electrically the floating position.  
Specify the voltage: **12 V.DC. - 24 V.DC.**

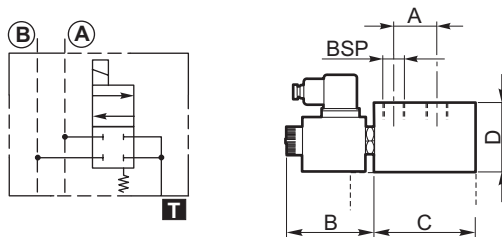

	A	B	C	D	BSP
<b>Q30</b>	34 (1.339)	69 (2.717)	80 (3.150)	80 (3.150)	3/8"

**Fiancata di scarico**

**Outlet section**



**13 - Tipo fiancata di scarico / Outlet section type**

		Q30	GSV50
<b>F3D</b>	Fiancata di scarico <i>Outlet section</i>	•	•
<b>F6D</b>	Fiancata di scarico con alimentazione in pressione per altri componenti (carry-over) <i>Outlet section and high pressure (carry-over)</i>	•	•

**F3D**

Fiancata di scarico  
*Outlet section*

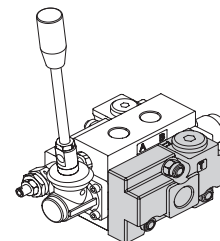
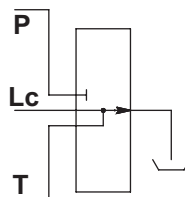

**F6D**

Fiancata di scarico con alimentazione in pressione per altri componenti (carry-over)  
*Outlet section and high pressure (carry-over)*

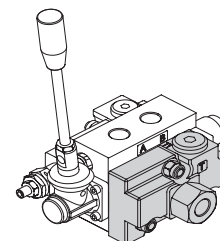
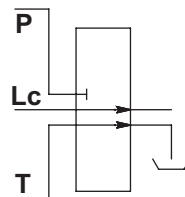

Note aggiuntive	Additional notes
-----------------	------------------

Q30	—	F7SPR	N120	30	M	—	2x	103	A1/D41	V30	R250	V01	—	F3D	—	12V	—	2E
1		2	3	4	5			7	8	10	11	12		13		16		17

**16 - Note aggiuntive / Additional notes**

**12V, 24V**  
**S Alluminio** (pag. B-6 ... B-10)

Codice **asta di comando** (vedi tabella seguente)

**16 - Additional notes**

**12V, 24V**  
**S Aluminium** (page B-6 ... B-10)

**Control lever code** (see next table)

Codice / Code	Versione / Version	M	L	D	A	B	Colore / Color
---------------	--------------------	---	---	---	---	---	----------------

Per comando elettrico / For electric control <b>Q30 - GSV50</b>								
<b>06.029.28945</b>	<b>1</b>	Standard / Standard	Ø7	133 (5.236)	20 (0.787)	57 (2.244)	15 (0.591)	Nero / Black
<b>06.029.29349</b>	<b>1</b>	Lunga / Long version	Ø7	201 (7.913)	20 (0.787)	57 (2.244)	15 (0.591)	Nero / Black
<b>06.029.30951</b>	<b>2</b>	Standard con oblo' / Standard with lens	Ø7	143 (5.630)	32 (1.260)	46 (1.811)	15 (0.591)	Nero / Black

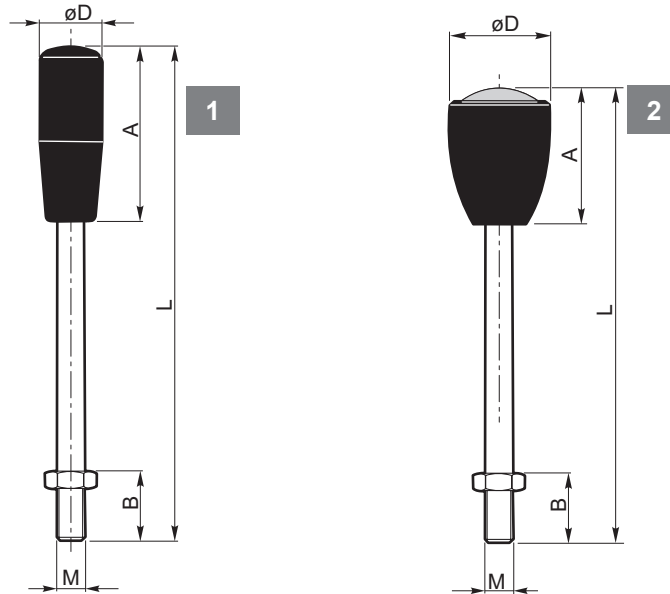

Note aggiuntive	Additional notes
-----------------	------------------

Q30	—	F7SPR	N120	30	M	—	2x	103	A1/D41	V30	R250	V01	—	F3D	—	12V	—	2E
1		2	3	4	5			7	8	10	11	12		13		16		17

**17 - Numero sezioni di lavoro**  
Specificare il numero delle sezioni di lavoro (es. 2E) utilizzate tenendo sempre in considerazione che il limite massimo è 10.

**17 - Number of working sections**  
Specify the number of working sections (for ex. 2E) used, always taking into account the maximum limit of 10.

**Q30**

**DISTRIBUTORI A COMANDO ELETTRICO DIRETTO  
CON FIANCATA PROPORZIONALE F7SPR  
DIRECTIONAL CONTROL VALVE WITH DIRECT ELECTRICAL  
CONTROL AND PROPORTIONAL SECTION F7SPR**

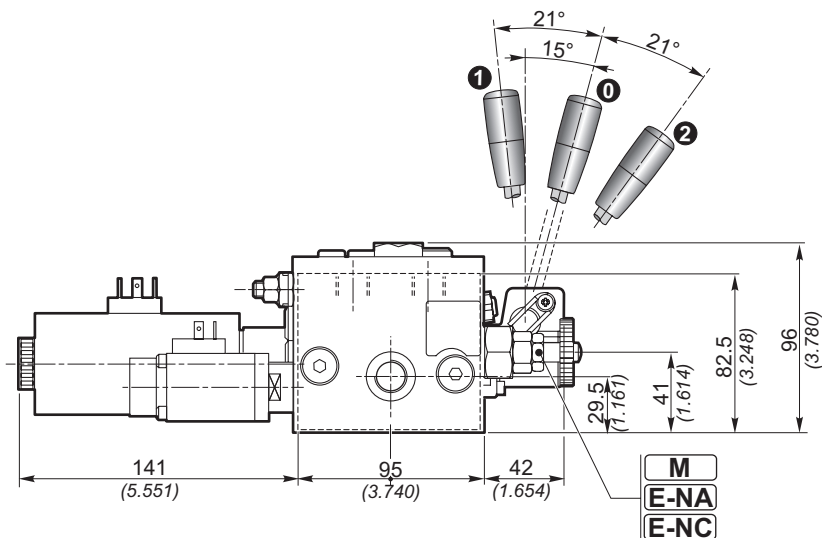
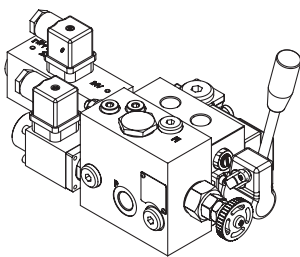

**Sicurezza manuale  
Manual safety device**

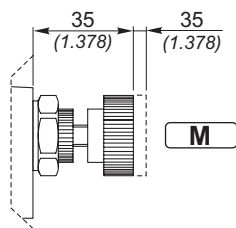

G 1/4" Attacco per eventuale manometro  
G 1/4" Coupling for pressure gauge (if needed)

n°4 fori di fissaggio: M6 per attacchi metrici e Gas 3/8"-24UNF per attacchi SAE  
n°4 mounting holes: M6 for metric and Gas ports 3/8"-24UNF for SAE ports

**Sicurezza elettrica  
Electrical safety device**

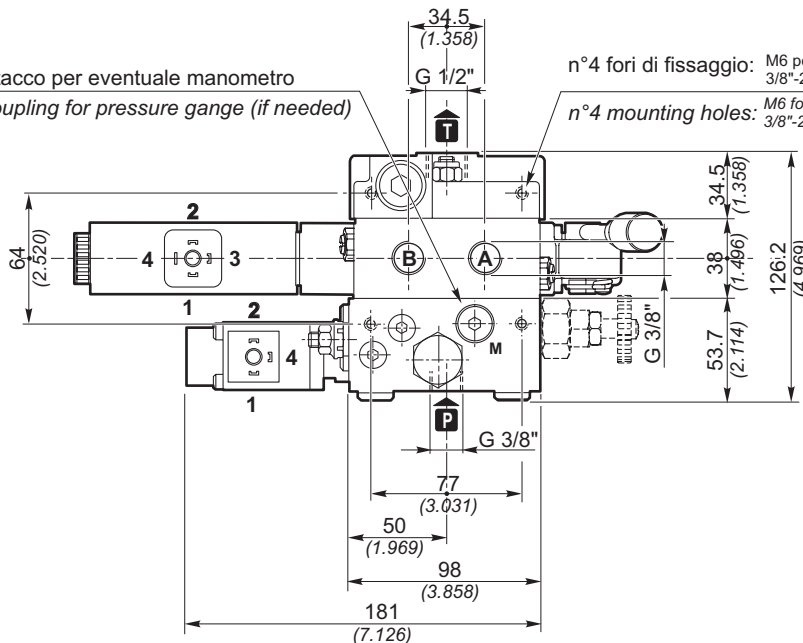
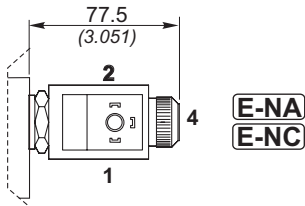

**Q30** — **F7SPR** **N120** **30** **M** — 2x **103** **A1/D41** **V30** **R250** **V01** — **F3D** — **12V** — **2E**  
1 2 3 4 5 7 8 10 11 12 13 16 17

Filettature disponibili / Available ports

Bocche Ports	BSP (standard)	SAE
<b>P1</b>	G 3/8"	3/4" - 16UNF (SAE 8)
<b>P2</b>	G 3/8"	3/4" - 16UNF (SAE 8)
<b>A-B</b>	G 3/8"	9/16" - 18UNF (SAE 6)
<b>T1</b>	G 1/2"	7/8" - 14UNF (SAE 10)
<b>T2</b>	G 1/2"	3/4" - 16UNF (SAE 8)

Tappo per carry-over (su uscita T1)  
Carry-over plug (on T1 port)

	T1	
		G 1/2"
	<b>X</b>	G 3/8" - G 1/2"
	<b>T1</b>	7/8"-14UNF (SAE 10)
	<b>X</b>	3/4" - 16UNF (SAE 8)

**Limiti d'impiego / Use limits**

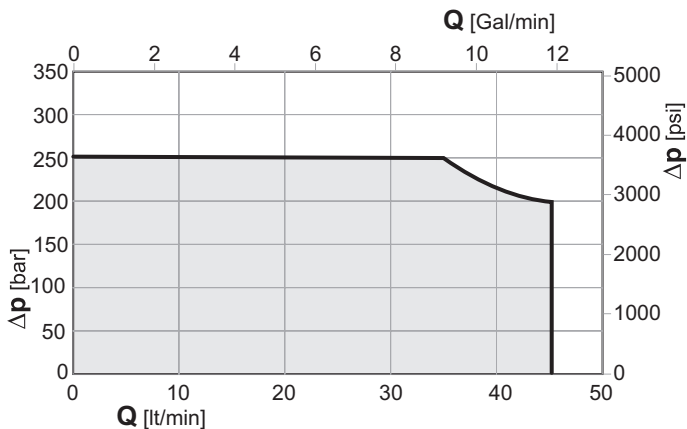

**Perdite di carico con il cursore in posizione neutra**

( $\Delta p$  in funzione del numero di sezioni attraversate)

**Pressure drop with spool in neutral position**

( $\Delta p$  depending on the number of the crossed sections)

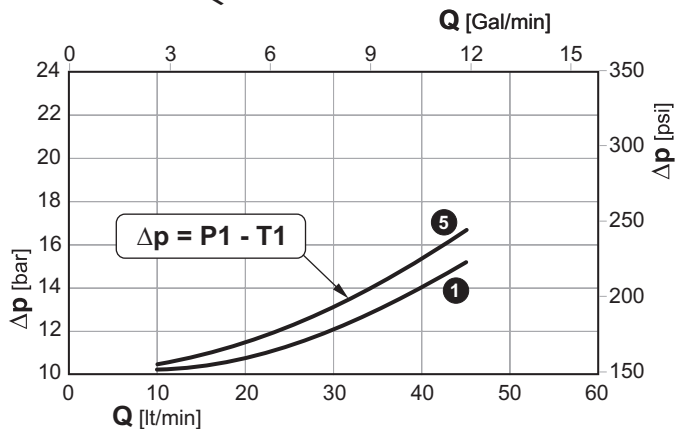
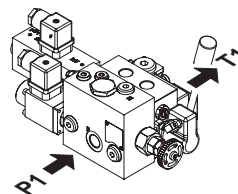

**Perdite di carico con il cursore in posizione di lavoro**

( $\Delta p$  in funzione del numero di sezioni attraversate)

**Pressure drop with spool in working position**

( $\Delta p$  depending on the number of the crossed sections)

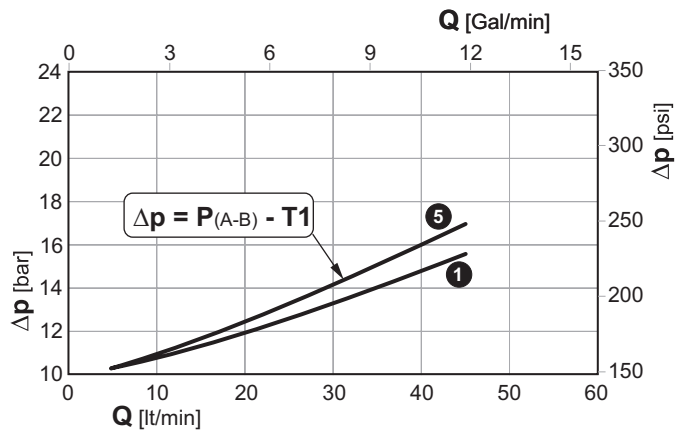
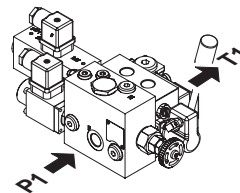
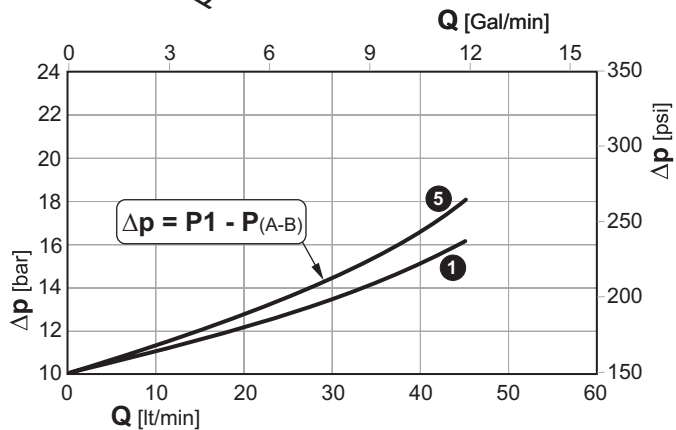
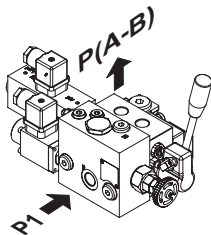

1 5 Sezioni / Sections

# GSV50

## DISTRIBUTORI A COMANDO ELETTRICO DIRETTO CON FIANCATA PROPORZIONALE F7SPR DIRECTIONAL CONTROL VALVE WITH DIRECT ELECTRICAL CONTROL AND PROPORTIONAL SECTION F7SPR

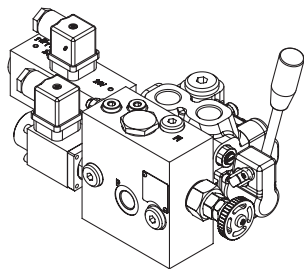

### Sicurezza manuale Manual safety device

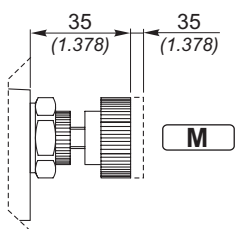

G 1/4" Attacco per eventuale manometro  
G 1/4" Coupling for pressure gauge (if needed)

### Sicurezza elettrica Electrical safety device

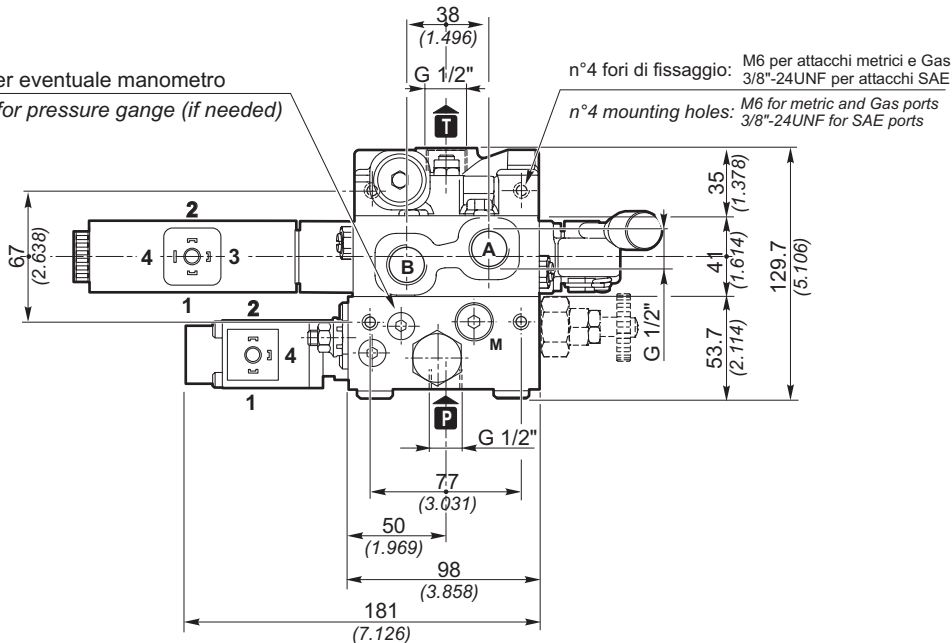
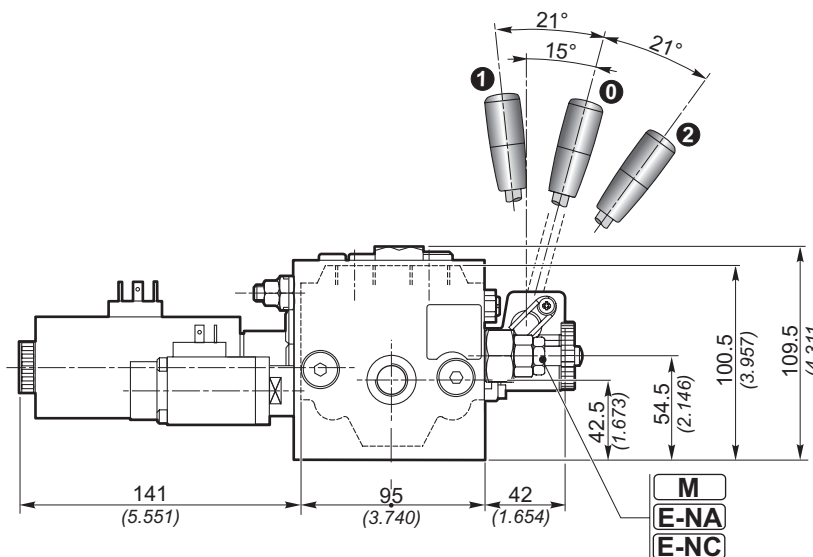
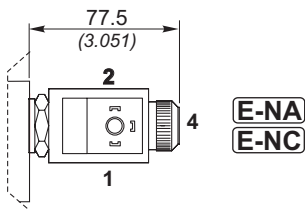

GSV50 — F7SPR N120 30 M — 2x 103 A1/D41 V30 R250 V01 — F3D — 12V — 2E

1 2 3 4 5 7 8 10 11 12 13 16 17

### Filettature disponibili / Available ports

Bocche Ports	BSP (standard)	SAE
P1	G 1/2"	3/4" - 16UNF (SAE 8)
P2	G 1/2"	3/4" - 16UNF (SAE 8)
A-B	G 1/2"	3/4" - 16UNF (SAE 8)
T1	G 1/2"	7/8" - 14UNF (SAE 10)
T2	G 1/2"	3/4" - 16UNF (SAE 8)

### Tappo per carry-over (su uscita T1) Carry-over plug (on T1 port)

19.7 (0.776)

X T1

T1	G 1/2"
X	G 3/8" - G 1/2"
T1	7/8"-14UNF (SAE 10)
X	3/4" - 16UNF (SAE 8) 7/8"-14UNF (SAE 10)

**Limiti d'impiego / Use limits**

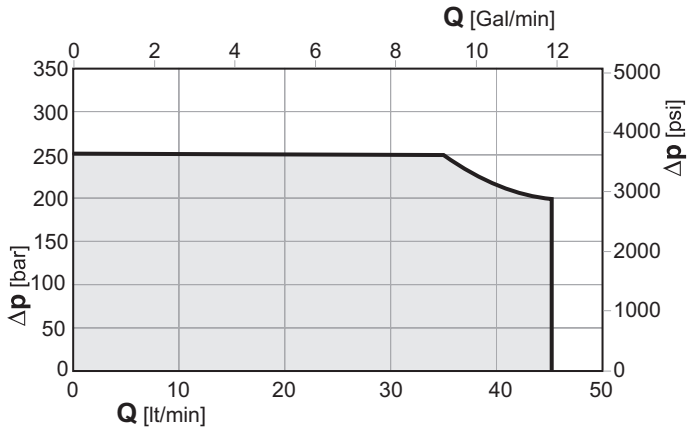

**Perdite di carico con il cursore in posizione neutra**

( $\Delta p$  in funzione del numero di sezioni attraversate)  
**Pressure drop with spool in neutral position**  
( $\Delta p$  depending on the number of the crossed sections)

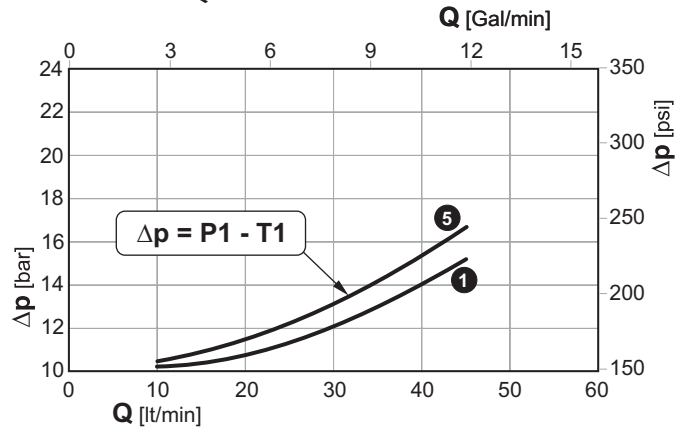
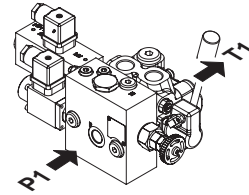

**Perdite di carico con il cursore in posizione di lavoro**

( $\Delta p$  in funzione del numero di sezioni attraversate)  
**Pressure drop with spool in working position**  
( $\Delta p$  depending on the number of the crossed sections)

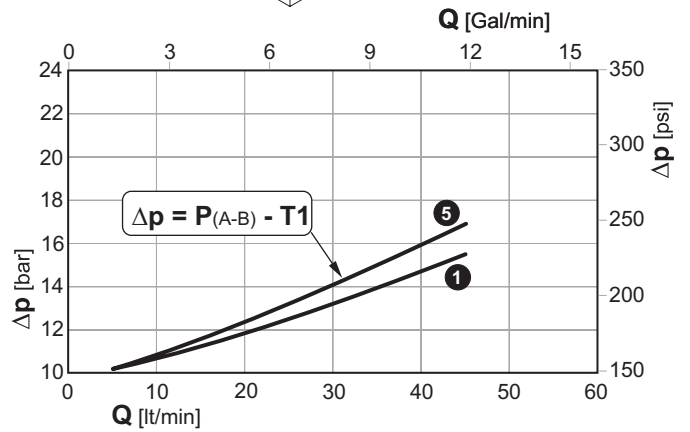
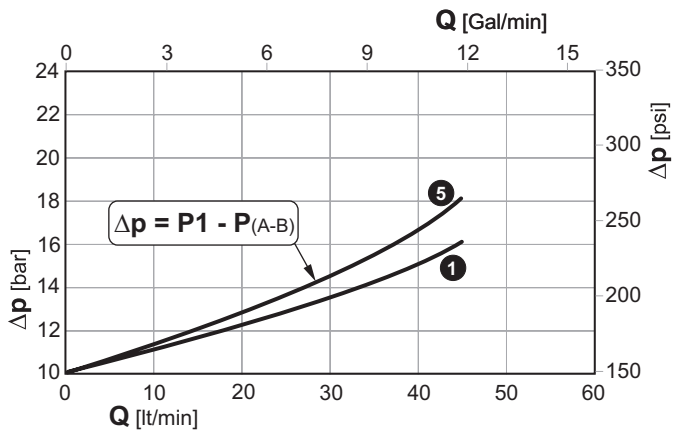
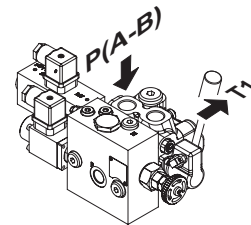
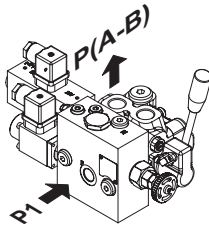

1 5 Sezioni / Sections



**Walvoil nel mondo - Walvoil worldwide**  
**Sede principale, Filiali e Uffici di rappresentanza**  
**Headquarters, Subsidiaries and Representative Offices**

**Walvoil S.p.A. - Headquarters**

Via Adige, 13/D . 42124 Reggio Emilia . Italy  
Phone +39 0522 932411 . info@walvoil.com - www.walvoil.com

**Business Unit Hydrocontrol**

Via San Giovanni, 481 . 40060 Osteria Grande  
Castel S. Pietro Terme . Bologna . Italy  
Phone +39 051 6959411

**Galtech Site**

Via Portella della Ginestra, 10 . 42025 Cavriago  
Zona Industriale Corte Tegge . Reggio Emilia . Italy  
Phone +39 0522 932411

**AUSTRALASIA**

**Walvoil Fluid Power Australasia Pty Ltd**

13 Vanessa Way . Delahey VIC 3037 . Melbourne . Australia  
TEL. 0061 458 918 750 . australasia@walvoil.com

**BRASILE . BRAZIL**

**Interpump Hydraulics Brasil Ltda - Walvoil Division**

Gilberto de Zorzi, 525 . Forqueta Caxias do Sul (RS)  
TEL. 0055 54 3223 2373 . infobrasil@walvoil.com

**CANADA**

**Galtech Canada Inc.**

3100, Jacob Jordan . Terrebonne . Qc J6X 4J6 . Canada  
Phone +1 450 477 1076 Ext:225 . info@galtechcanada.com

**CINA . CHINA**

**Walvoil Fluid Power (Shanghai) Company Limited**

24, Lane 129, Dieqiao Road . Pu Dong . Kanqiao Industrial Zone Shanghai (201319)  
TEL. 0086 21 60979800 . info@walvoil.com.cn

**Guangzhou Bushi Hydraulic Technology Ltd**

Shangwei Shaheshe, Yuehu Village . Xiancun, Xintang Town . Zengcheng City  
511335 Guangzhou . Guangdong Province China  
Phone +86 021 52380695 . fareast@hydrocontrol-inc.com

**COREA DEL SUD . SOUTH KOREA**

**Walvoil Fluid Power Korea Ltd.**

80-15, Oseongsandan 1Ro, Oseong-Myun, Pyungtaek, Kyungki . Korea 451-872  
TEL. +82 31 682 6030 . info@walvoil.co.kr

**FRANCIA . FRANCE**

**Walvoil Fluid Power France**

362 rue de Bretagne . 44540 Vritz  
TEL. 0033 2 41 94 41 06 . france@walvoil.com

**INDIA**

**HC Hydraulic Technology(P) LTD**

A5(B) Ngef Ancillary Indl. Estate . Whitefield Road  
Mahadevpura (Po) . Bangalore 560048 . India  
Phone +91 080 40454707 . info@hydrocontrol-india.com

**Walvoil Fluid Power (India) PVT. LTD.**

No 23, Doddanakundi Industrial Area Mahadevapura Post Behind Graphite India  
Bangalore 560 048  
TEL. 0091 80 41842900 . info@walvoil.co.in

**U.S.A.**

**Hydrocontrol Inc.**

1109, Technology Drive . Red Wing . MN 55066 . U.S.A.  
Phone +1 651 212 6400 . usa@hydrocontrol-inc.com

**Walvoil Fluid Power Corporation**

4111 North Garnett Tulsa, OK 74116, USA  
TEL. 001 918 858 7100 . info@walvoilfluidpower.com

1° edizione Agosto 2015 - 1<sup>st</sup> edition August 2015

[www.galtech.it](http://www.galtech.it)



D1WGEZ01E

